

**ingun**<sup>®</sup>

Test Probes · Test Fixtures

## Test Fixtures

Manual

Pneumatic

Vacuum

Inline

Accessories

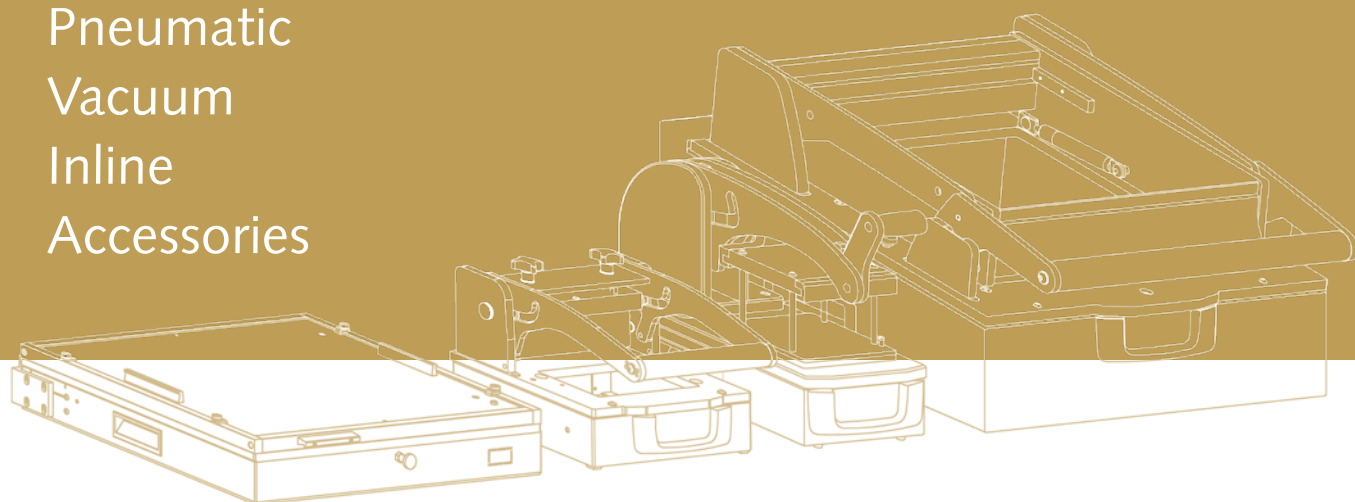

# Competent in your field



*Telecommunications*



*Information electronics*



*Consumer electronics*



*Automotive*

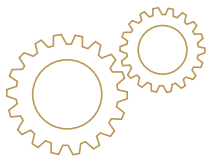

*Engineering*

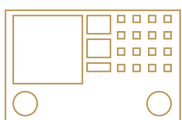

*Tests and measurements*



*Aviation and space technology*



INGUN test fixtures are used by our customers in various industries and enable precise, accurately repeatable testing of electronic functional units. As a leading company, INGUN offers standardised test fixtures for all common test systems - from manual, pneumatic and vacuum-operated test fixtures to inline exchangeable kits - and an unmatched variety of test fixture accessories.

Well-known customers rely on the high quality standard - Made in Germany - and appreciate the high modularity of standardised test equipment. There is certainly a test fixture for your application too. Contact us for your test fixture in renowned INGUN quality.

**You will find more information about INGUN, test fixtures and accessories on pages 4 to 16.**

# INGUN test fixture

Reliable, robust test equipment of the highest quality - Made in Germany

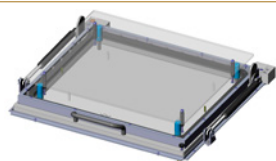
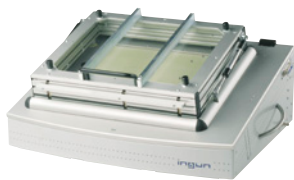
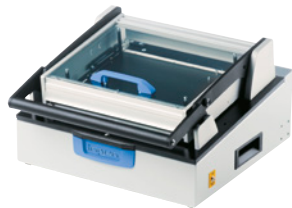

## Product information

Product range  
Functional principle  
Product positioning  
Materials

## Manual Test fixture (MA)

Manual test fixture MA  
Product information

Manual test fixtures  
MA xxx

Manual test fixtures  
MA xxxx

Radio frequency  
exchangeable kits  
ATS MAxx/HF

Functional units  
FB

## Pneumatic test fixtures (PAZ/PA)

Pneumatic test fixtures  
PAZ xxx

Pneumatic test fixtures  
PA xxxx

## Vacuum test fixtures (VA)

Vacuum test fixture VA  
Product information

Vacuum test fixture without  
test system interface

Vacuum test fixture with  
test system interface

- COBHAM (AEROFLEX)
- DIGITALTEST
- KEYSIGHT
- REINHARDT
- SPEA
- TERADYNE
- PYLON
- VIRGINIA PANEL

## VA designs

Pressure frame units (NDH)  
Drive units (ATE VA)  
Vacuum hoods (VKH)  
Additional contacts (ZSK)

## Inline exchangeable kits (WS)

Inline exchange kits for

- KEYSIGHT
- KONRAD
- SPEA

## Customising accessories

Interface blocks  
Marking units  
Side approach mechanisms  
Miscellaneous

# INGUN – Quality through precision



## A family business with persuasive know-how

The family business, located in Constance at the Lake of Constance, has produced and sold test probes and test fixtures all over the world since 1971, and in that time developed into the number 1 company in testing technology.

INGUN products are manufactured exclusively at the German site under the slogan **MADE IN GERMANY**, and delivered worldwide from there. With their high precision and established know-how, INGUN would like to continue to shape the future together with you.

Your competent partner since 1971

## The path to success



1971	1976	1979	1995	2005	2007	2018
<ul style="list-style-type: none"> <li>- Foundation of "INGenieur UNion" (INGUN) - in English engineer union - founded in Constance by Werner H. Heilmann as a trading company for electronic components</li> <li>- Wolfgang Karl joins the company</li> <li>- 7 employees</li> </ul>	<ul style="list-style-type: none"> <li>- INGUN launches their first radio frequency probe - GKS-HF 408 - in May 1976</li> </ul>	<ul style="list-style-type: none"> <li>- Presentation of the first vacuum adapter manufactured in Germany at the Productronica trade fair in Munich</li> </ul>	<ul style="list-style-type: none"> <li>- Fully automatic assembly of test probes</li> <li>- Certification in accordance with DIN EN ISO 9001</li> <li>- 108 employees</li> </ul>	<ul style="list-style-type: none"> <li>- Introduction of counterfeit protection for spring-loaded test probes</li> <li>- Now represented worldwide in 28 countries</li> <li>- Employees: 145</li> </ul>	<ul style="list-style-type: none"> <li>- Wolfgang Karl is appointed to the board of directors</li> <li>- His son, Armin Karl, takes over management</li> </ul>	<ul style="list-style-type: none"> <li>- Over 45 years INGUN</li> <li>- Represented worldwide on every continent</li> <li>- 11 Subsidiaries</li> <li>- 350 Employees</li> </ul>



# Worldwide in contact



### Your reliable partner worldwide

*INGUN is represented worldwide by agencies and 11 of their own subsidiaries. Many of their current agencies have worked together with the test equipment specialist since the company was founded.*

### Your local contact partner

Only those who understand their customers can offer the best products and services. The INGUN group can be reached via one of their many subsidiaries and agencies worldwide – one of which is guaranteed to be near you.

Find your contact person now:  
[www.ingun.com/contact](http://www.ingun.com/contact)



# The INGUN Product Finder - Find your individual test solution online!

---



- Find, compare & inquire about 11,000 products online
  - Filter targeted & limit search results
  - See technical details & download data sheets

Visit our website:

[www.ingun.com](http://www.ingun.com)

# Product information

The **product information pages** present and explain all relevant information on test fixtures, inline exchangeable kits and accessories.

INGUN offers an unbeatable range of test fixtures and accessories. The product number is based on a defined **naming key** and contains relevant information about the product group, series, size, operating type, contacting type, housing, mounting plate, internal interface and test system connection.

All test fixtures are **modularly designed**, have a similar functional principle, and feature a probe plate, pressure plate and pressure frame unit. They essentially differ in how the parallel contact stroke for contacting the electronic device under test (DUT) is generated.

Depending on the DUT to be tested and the test system available, various test fixtures are available. The **product range** includes test equipment for testing small, medium and high volumes, suitable for **batch testing** (or small series), **series testing** and **mass testing**.

By selecting the optimum test fixture for the test requirements, precise, safe, and reproducible contacting can be carried out.

Various **materials** are used to optimally fulfil the testing requirements. In this context, INGUN fulfils all relevant **environmental regulations**.

Take a look at our **operating instructions** and our **technical manual**. Here, installers will find important information on the proper operation and service of the test fixture, inline interchangeable kits and exchangeable kits.

The operating instructions and technical manual are available for download on our website **www.ingun.com**.

## Product information

Product description	8
Product range	9
Functional principle	10
Test system interface	11
Product positioning	12
Test method	14
Material and ESD	15
Quality assurance	16

# Product designation - Clear, structured product names

## Naming key

The naming key for product designation allows clear identification and classification of INGUN test fixtures thanks to the logical structure using their individual features.

Group (MA, PA, VA, ...)	Series (20xx, 21xx, 32xx, ...)	Size (xx09, xx11, xx12, ...)	Operating type (T = Tandem = 2 Drive units)	Contacting (1 = 1-stage, 2 = 2-stage = FCT + ICT)	Housing (D = desk, F = flat)	Mounting plate (H = hinged)	Internal interface (Number of transfer blocks/ contacts)	Test system connection (Digitaltest, Spea, Teradyne, ...)
----------------------------	-----------------------------------	---------------------------------	--	--	---------------------------------	--------------------------------	---	--

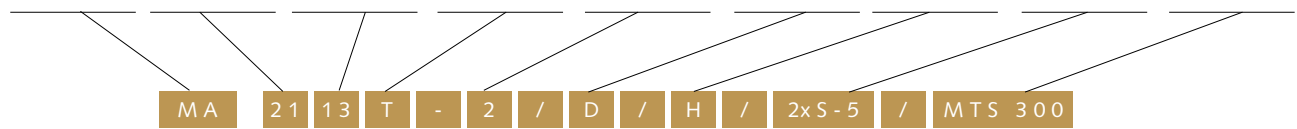

Manual test fixture (example)



Pneumatic test fixture (example)



Vacuum test fixture (example)

## Common abbreviations

<b>ABF</b>	Check	<b>KTP</b>	Probe plate	<b>SB</b>	Interface block
<b>ADP</b>	Moving plate	<b>LL</b>	Fibre optic cable	<b>SBE</b>	Screwing unit
<b>ASV</b>	Suction device	<b>MA</b>	Manual test fixture	<b>SD</b>	Silencer
<b>ATE</b>	Drive unit	<b>MAP</b>	Ground plate	<b>SIS</b>	Safety switch
<b>ATS</b>	Exchangeable kit	<b>ME</b>	Marking unit	<b>SK</b>	Starter kit
<b>D</b>	Desk housing	<b>MTP</b>	Mounting plate	<b>STK</b>	Plug contact
<b>ESD</b>	Electrostatic discharge	<b>NDH</b>	Pressure frame unit	<b>SWS</b>	Spare part engraver kit
<b>F</b>	Flat housing	<b>NHP</b>	Pressure frame plate	<b>TAB</b>	Button activation
<b>FB</b>	Functional unit	<b>NHS</b>	Pushrod	<b>TF</b>	Transfer field
<b>FED</b>	Pressure spring	<b>NSRL</b>	Low voltage directive	<b>VA</b>	Vacuum test fixtures
<b>FEZ</b>	Tension spring	<b>OTC</b>	Opens Test Component	<b>VD</b>	Vacuum seal
<b>FCT</b>	Functional test	<b>OTE</b>	Opens Test Electronics	<b>VER</b>	Locking mechanism
<b>FS</b>	Tooling pin	<b>OTU</b>	Opens Test Unit	<b>VG</b>	VG multipoint connector
<b>GDF</b>	Gas pressure spring	<b>PA</b>	Pneumatic test fixture	<b>VK</b>	Vacuum cassette
<b>GFS</b>	Spring-loaded tooling pin	<b>PAS</b>	PCB support pin	<b>VKH</b>	Vacuum cover
<b>HBS</b>	Stroke limiting disc	<b>PAZ</b>	Pneumatic gear wheel fixture	<b>VSL</b>	Stiffener bar
<b>HG</b>	Tall housing	<b>PP</b>	Personality pin	<b>VSP</b>	Wiring guard plate
<b>HZ</b>	Stroke counter	<b>PS</b>	Test plug	<b>VZ</b>	Pre-centring pin
<b>ICT</b>	In-circuit test	<b>PSA</b>	Test plug mounting	<b>WS</b>	Interchangeable kit (inline)
<b>KRM</b>	Cleaning mat	<b>RC</b>	Receiver	<b>WSO</b>	Interchangeable kit, top part
<b>KS</b>	Receptacle	<b>S-X</b>	Interface for X interface blocks	<b>WSP</b>	Interchange. kit, PCB support plate
<b>KT</b>	Contact terminal	<b>SAM</b>	Side approach mechanism	<b>WSU</b>	Interchangeable kit, bottom part
<b>KTE</b>	Probe plate unit			<b>ZSK</b>	Additional contact unit









# Product range - Test fixtures, Inline interchangeable kits and accessories

## Product range

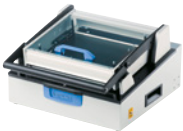
INGUN offers a versatile product range with test fixtures and inline interchangeable kits for all common test systems and an unbeatable variety of accessories.

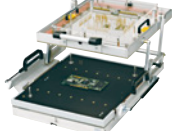
The product range includes the following product groups: manual test fixture (MA), pneumatic test fixture (PAZ/PA), vacuum test fixture (VA), inline interchangeable kits (WS)

and accessories. The test fixture and inline interchangeable kits differ in how the parallel contacting stroke is generated for contacting the electronics functional unit. The customising accessories include components which are necessary for every customisation, as well as project-specific accessories.

Test fixture / inline interchangeable kits				Customising accessories	
<p><b>Manual test fixtures (MA)</b></p>  <p>Contact stroke is generated <b>manually</b></p> <p>Products: - MA xxx - MA 20xx - MA 21xx - MA 32xx</p>	<p><b>Pneumatic test fixtures (PAZ/PA)</b></p>  <p>Contact stroke is generated with <b>compressed air</b></p> <p>Products: - PAZ 200 - PAZ 220 - PA 2130 - ...</p>	<p><b>Vacuum test fixtures (VA)</b></p>  <p>Contact stroke is generated by <b>negative pressure (vacuum)</b></p> <p>Products: - VA 2030 - VA 2040 - VA 2070 - ...</p>	<p><b>Inline interchangeable kits (WS)</b></p>  <p>Contact stroke is generated by <b>test system</b></p> <p>For test systems: - KEYSIGHT - KONRAD - SPEA - ...</p>	<p><b>Customising necessity accessories</b></p>  <p>Components required for every customisation</p> <p>Products: - PAS - FS - VZ - NHS - ...</p>	<p><b>Project-specific accessories</b></p>  <p>Function units for project-specific customisation</p> <p>Products: - SB - ME - SAM - PS / STK - ...</p>

Functions							
	Single-stage contacting, single-sided, bottom	Single-stage contacting double-sided, bottom + top	Dual-stage contacting, single-sided, bottom (FCT + ICT)	Tandem version (2 drive units on one housing)	Interchangeable kit system	Standard test fixture KITS <small>(Available with and without test system interface)</small>	Customer-specific customisations
Manual test fixtures (MA)	✓	✓	✓	✓	✓	✓	✓
Pneumatic test fixtures (PAZ/PA)	✓	✓	✓	-	✓	✓	✓
Vacuum test fixtures (VA)	✓	✓	✓	✓	-	✓	✓
Inline interchangeable kits (WS)	✓	✓	✓	-	✓	✓	✓

# Test fixture

## Design and functional principle

### Design and functional principle

Test fixtures are available as interchangeable kit and stand-alone test fixture. Interchangeable kit test fixtures offer the advantage of testing different exchangeable kits with just one basic unit. All test fixtures and exchangeable kits are modular and have a similar functional principle to generate

the parallel contact stroke for contacting the device under test (DUT). The test fixtures consist of a housing unit (P/FGH) and a drive unit (ATE), the exchangeable kits from a pressure frame unit (NDH) and a probe plate unit (KTE).

### Design

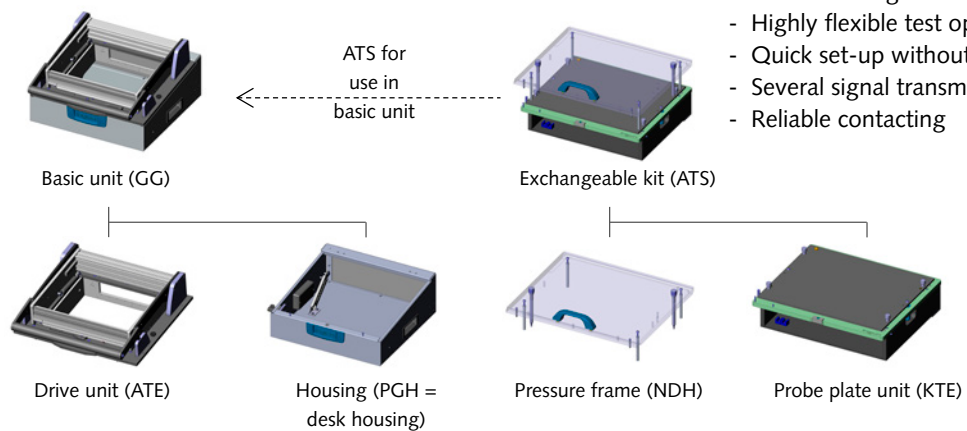

- Modular design
- Highly flexible test options
- Quick set-up without tools
- Several signal transmission options
- Reliable contacting

### Functional principle

The parallel contact stroke is generated **manually** (pneumatically or by negative pressure).

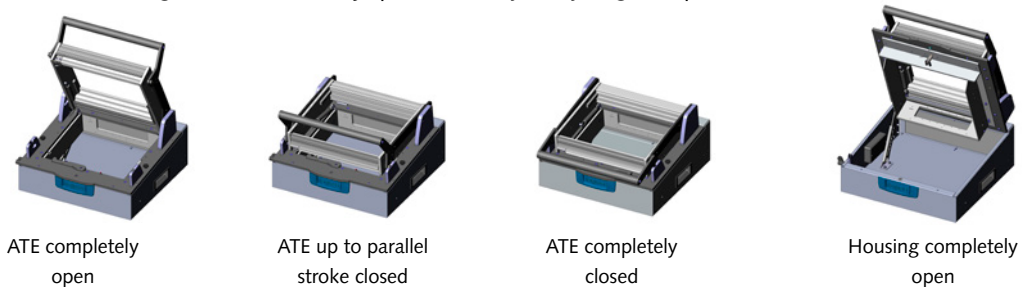

### Signal transmission

For interchangeable kit test fixtures, signal transmission is dependent on whether the product group is fitted with VG strips (MA xxx test fixture) or with interface blocks (MA

xxxx test fixture). The signal is transmitted through two electrical connectors mounted opposite each other, which are reliably contacted via the internal interface.

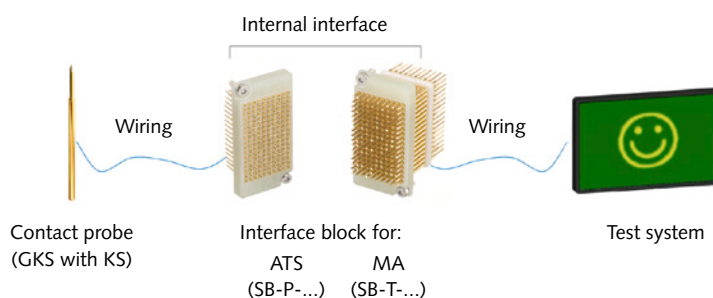

# Test fixture

## Test system interface

### Connection of the test system interface

INGUN test fixtures are available with and without test system interface for all common test systems. Depending on the test system used, the test system interface is attached to the bottom or rear of the housing. All test adapters are

available as a standard test fixture kit and can be customised according to customer's specifications. In general, all test system interfaces can be connected. Contact us if your test system interface is not available as a standard test fixture kit.

### Examples of test system interfaces mounted on the bottom of fixture housing

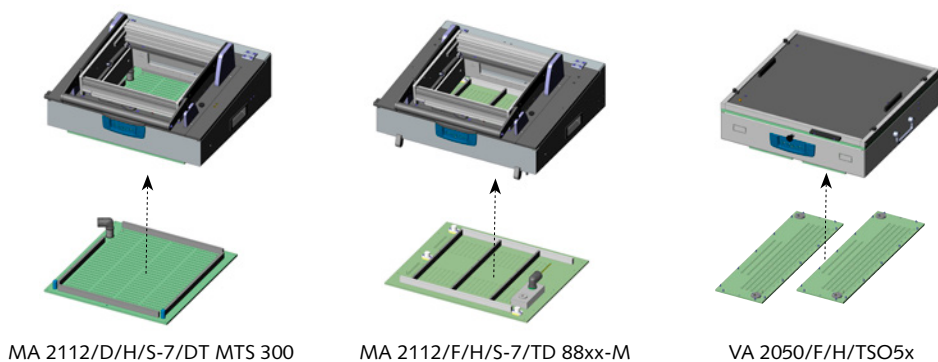

### Examples of test system interfaces mounted on the rear of fixture housing

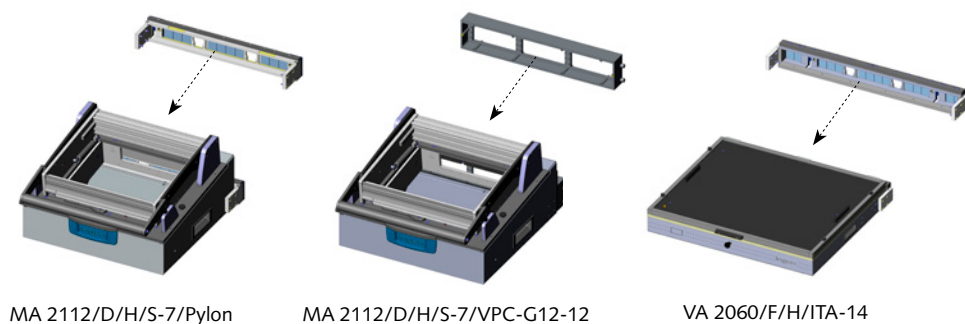

# Product positioning

## The right test fixture for every test requirement

In the production of electronic units such printed circuit boards (PCBs), the three production areas, **batch**, (or small series), **series**, and **mass production**, are distinguished by the production volume. Within each production area, different versions of the same electronic unit can be produced. As a result, the versions of the test fixture to be used in each case vary depending on the **number of pieces** to be **tested** in particular with regard to the maximum contact force, the generation of contact force and the maximum load cycles and the diversity of versions to be tested.

Thus, with a small number of versions, mainly **stand-alone test fixtures** are used and, in the case of a large number of versions primarily **interchangeable kit test fixtures** are used.

Besides a company's own testing philosophy, the number of pieces to be tested is often the decisive purchase criterion for the selection of a test fixture.

Benefit from the variety of test fixtures provided by INGUN - suitable for every production area.

Production of electronic units and the test fixtures mainly used for testing

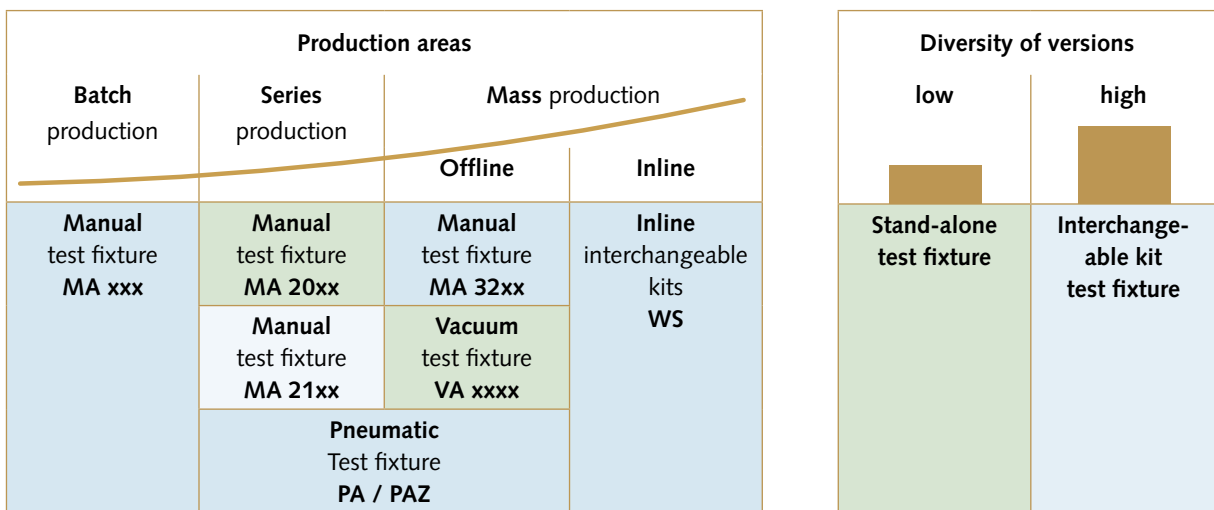

Range of services of INGUN test fixtures

MA xxx	MA 20xx	MA 21xx	MA 32xx
Batch testing	Series testing	Series testing	Mass testing
Interchangeable test fixture	Stand-alone test fixture	Interchangeable test fixture	Interchangeable test fixture
Max. load cycles	Max. load cycles	Max. load cycles	Max. load cycles
Max. contact force	Max. contact force	Max. contact force	Max. contact force
Max. useable area	Max. useable area	Max. useable area	Max. useable area
PA xxxx	PAZ xxx	VA 2xxx	VA 207x
Series testing	Mass testing	Mass testing	Mass testing
Interchangeable test fixture	Interchangeable test fixture	Stand-alone test fixture	Stand-alone test fixture
Max. load cycles	Max. load cycles	Max. load cycles	Max. load cycles
Max. contact force	Max. contact force	Max. contact force	Max. contact force
Max. useable area	Max. useable area	Max. useable area	Max. useable area



### Maximum Features at a glance

Information under laboratory conditions for full customisation	Activation (Contact stroke generating)	Maximum contact force [N]	Maximum clamping force (at full load) [N]	Maximum usable area (W x D) [mm]	Expandable with functional units (FB)	Version with test system interface available	Page
<b>MA xxx</b>	Manual	300	130/60/30/30	160 x 100	X	-	23 – 28
<b>MA 20xx</b>	Manual	2,000	120	440 x 310	X	X	29 – 33
<b>MA 21xx</b>	Manual	2,000	120	540 x 310	X	X	34 – 48
<b>MA 32xx</b>	Manual	2,000	70	540 x 310	X	-	49 – 55
<b>PAZ xxx</b>	Pneumatic	2,500	omitted	500 x 180	-	-	81 – 84
<b>PA xxxx</b>	Pneumatic	700	omitted	250 x 200	-	-	85
<b>VA 2xxx</b>	Vacuum	22,000	omitted	535 x 440	-	X	91 – 125
<b>VA 2070S</b>	Vacuum	11,000	omitted	305 x 380	-	X (Keysight)	102 – 104
<b>VA 2073L</b>	Vacuum	24,000	omitted	670 x 380	-	X (Keysight)	105

### Test fixture selection

#### Manual test fixture (MA)

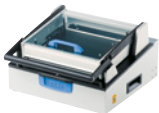

For tests which require the parallel contact stroke to be manually generated, have an moderate number of test points to be tested, and when it is necessary to upgrade the functionality, ease of use and degree of automation by means of functional units to meet the requirements of the test application.

#### Pneumatic test fixture (PAZ / PA)



For tests which require the parallel contact stroke to be automated using compressed air, have a moderate number of test points, and when it is necessary to perform multiple contacts, e.g. if the penetration quality is not sufficient after the first contact.

#### Vacuum test fixtures (VA)

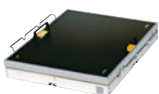

For tests with vacuum-powered test systems, which require the parallel contact stroke to be generated automatically by means of vacuum (negative pressure), have a large number of test points and when increased ease of use is required.

#### Inline interchangeable kits (WS)



For testing with in-line test cells in fully automated production lines, which require the parallel contact stroke to be automatically generated, to test a large number of test points, and for fully automated testing.

# Test method and challenges in test fixture customisation

## Test method

When testing electronic units such as printed circuit boards (PCBs), various test methods are available and can be applied individually or combined, depending on the depth of the test density or the nature of the device under test (DUT). A distinction is made between **functional test (FCT)**, **in-circuit test (ICT)**, **Boundary Scan Test** and **Open Test**.

In the **functional test (FCT)**, the function of individual unit networks or the 100% intended function of the unit is tested, but not individual components. Depending on the subsequent field of application, the environment is replicated and the electrical behaviour of the unit is checked. The test utilises externally available interfaces, as well as other accessible contacting positions.

With the **in-circuit test (ICT)**, all individual components of an assembly are tested for insertion, installation, and soldering errors, among other things. Hereby, short circuits and interruptions in PCB tracks, as well as defective, incorrect or

missing components can be detected. For this purpose, appropriate test points are planned during the design of the electronic unit, which are tapped and measured with spring-loaded test probes.

The **Boundary Scan Test** tests analogue and digital components that do not have direct physical access. This is usually the case in densely populated or multi-layer printed circuit boards (PCBs) and especially in integrated switching circuits if not all contacts can be accessed. The basis is a test logic implemented in the component. The Boundary Scan Test makes it possible to determine whether the correct component has been installed and properly soldered.

The **Open Test** is a specialised integrated circuit test procedure for testing the wire-bonded connections inside a circuit for breakdowns, short circuits, and soldering errors. The open test is a capacitive test that is carried out without penetrating the connections.

## Challenges in test fixture customisation

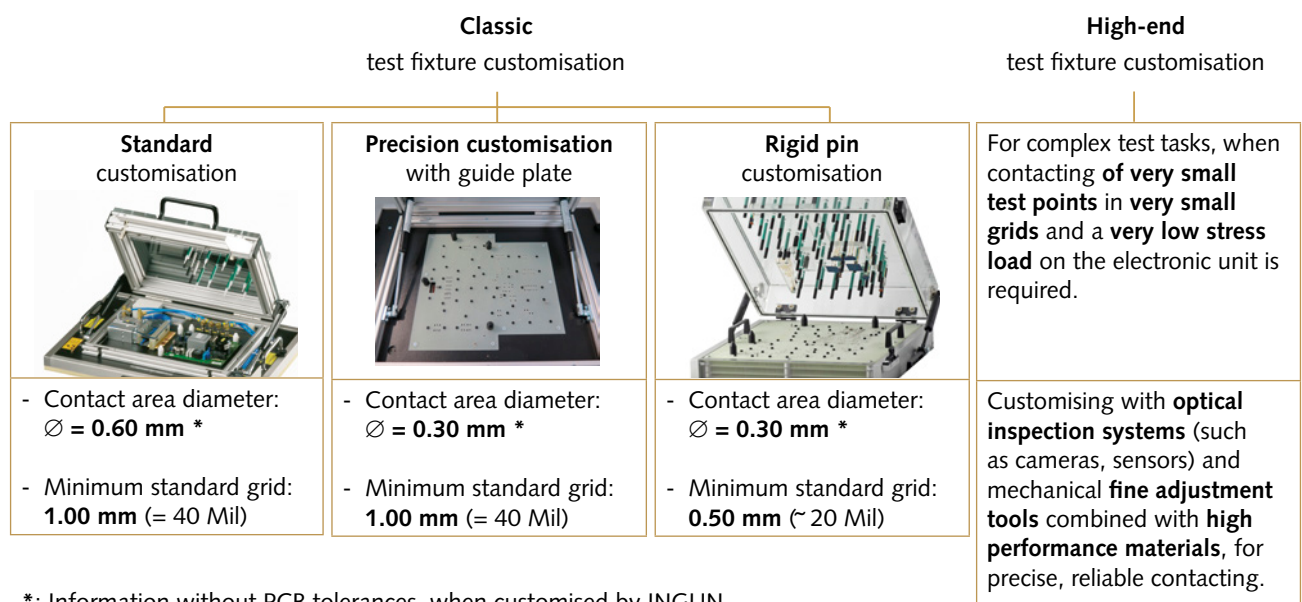

\*: Information without PCB tolerances, when customised by INGUN

# Materials and ESD - Quality through Precision

## Materials

By using high-quality materials, we ensure the high performance and high quality standard of our test fixtures.

### ESD-compliant materials

Electrostatic discharge (ESD) refers to the flow of an electric current due to potential differences, which causes a short, high-voltage electrical pulse and may permanently damage sensitive components due to excess voltage.

Materials with defined electrically conductive properties can continuously dissipate electrostatic charges in a defined time and in a controlled manner. These materials for protection against electrostatic discharge are classified based on their resistance properties and referred to as electrostatic dissipative or dissipative, if their specific surface resistance is between  $\geq 10^5$  and  $< 10^{11} \Omega$  (DIN EN 61340-5-1).

To protect sensitive components against ESD damage, especially during testing, **ESD-compliant materials and coatings** are used in our test fixtures, exchangeable kits, inline

interchangeable kits, and accessories to safely dissipate electrostatic charges.

### ESD quality control

For ESD customisation, the test fixture is equipped with ESD wiring (black wire), earthing system, and ESD antistatic tape connector. Before delivery, the field strength in the DUT area is measured. Here, the ESD-test fixture is connected to protective earth via its earthing system. Charge is placed with a charged foil. 20 seconds after the charge is applied, the electric field strength is measured using an electric field meter, whereby the measured value of 50 V/cm according to DIN EN 61340-5-1 must not be exceeded.

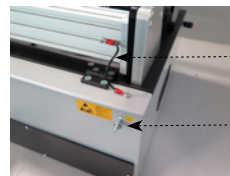

Part of the ESD wiring

Earthing system

Material	Elasticity module [MPa]	Surface resistance [ $\Omega$ ]	Temperature index [ $^{\circ}\text{C}$ ]	Permitted tolerances		Primarily used for	Advantage
				Thickness [mm]	Bending up to 400 mm [mm]		
FR4	24,000	$10^{12}$	130	$\pm 0.1$ (FR4, polished)	0.8	Probe plate	High stiffness
FR4 with ESD paint (coating thickness approx. 80 $\mu\text{m}$ )	24,000	$10^5 - 10^9$	130	$\pm 0.1$ (FR4, polished)	0.8	Probe plate	High stiffness with electric conductivity
CEM-1	12,000	$10^{12}$	130	$\pm 0.47$	0.8	Probe plate	Easy to process
Adaptonit	9,000	$10^5 - 10^{10}$	130	$\pm 0.47$	0.8	Mounting plate, pressure plate, wiring protection plate	Electrical conductivity
Acrylic glass	3,300	$10^6 - 10^7$	90	+ 1.6 / - 1.0	-	Pressure frame plate	Electrical conductivity

# INGUN sets standards in quality assurance

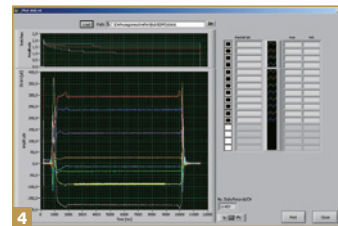
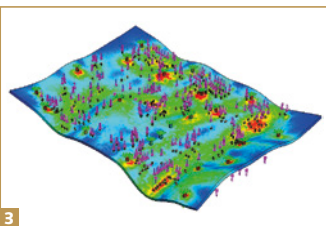
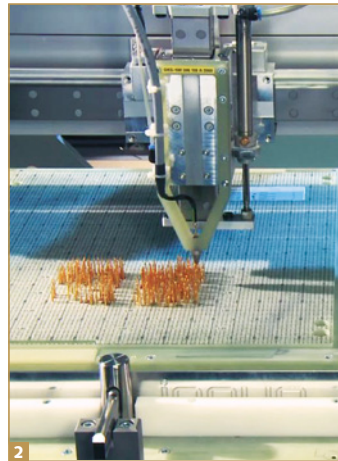
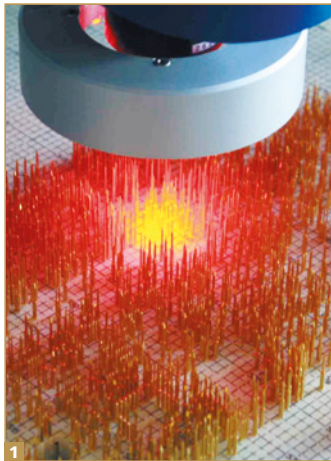

Following our motto **Quality through Precision**, we set standards in quality assurance, with state-of-the-art testing and measuring tools for excellent, environmentally friendly test fixture quality.

**1 Multi-sensor coordinates measuring machine**

- Checking the positional accuracy of the spring-loaded test probes and the contact quality of penetration in test points
- Checking of INGUN test fixtures and fixtures from other manufacturers

**2 Wiring tester**

- Fully automated wiring test
- Identification of incorrect wiring and short circuits

**3 FE Analysis**

- Functional unit analysis before start of production
- Analysis of the theoretical stress load of functional unit under mechanical stress

**4 DMS Analysis**

- Functional unit analysis post production
- Measurement of the actual stress load of functional units during contacting

## EC-Environmental Legislation

Numerous European Environmental Legislation Acts aim to ensure a high level of protection of human health and the environment. This legislation is always observed as part of the business decisions and actions taken by INGUN Prüfmittelbau GmbH.

INGUN has prepared official statements for the most important of the current European Environmental Legislation Acts, up-to-date versions of which are available on our homepage [www.ingun.com](http://www.ingun.com).

<b>INGUN</b> Environmental declaration of conformity	<b>REACH</b> EU ordinance 1907/2006	<b>RoHS</b> EC Directive 2011/65/EU	<b>ACPEIP</b> "China-RoHS"
<b>Conflict Minerals</b> Dodd-Frank Act	<b>BIOZID</b> EU/528/2012	<b>CLP</b> EC/1272/2008	<b>DMF</b> EC Directive 2009/251/EC
<b>PFOS</b> EC Directive 2006/122/EC	<b>UL-Certification</b> UL 94	<b>Radioactive contaminated stainless steel</b>	<b>PAK</b> ZEK 01.2-08



# Manual test fixture (MA)

- Manual test fixture MA product information
- Manual test fixture MA xxx
- Manual test fixture MA xxxx
- Radio frequency exchangeable kits ATS MAxx/HF
- Functional units FB

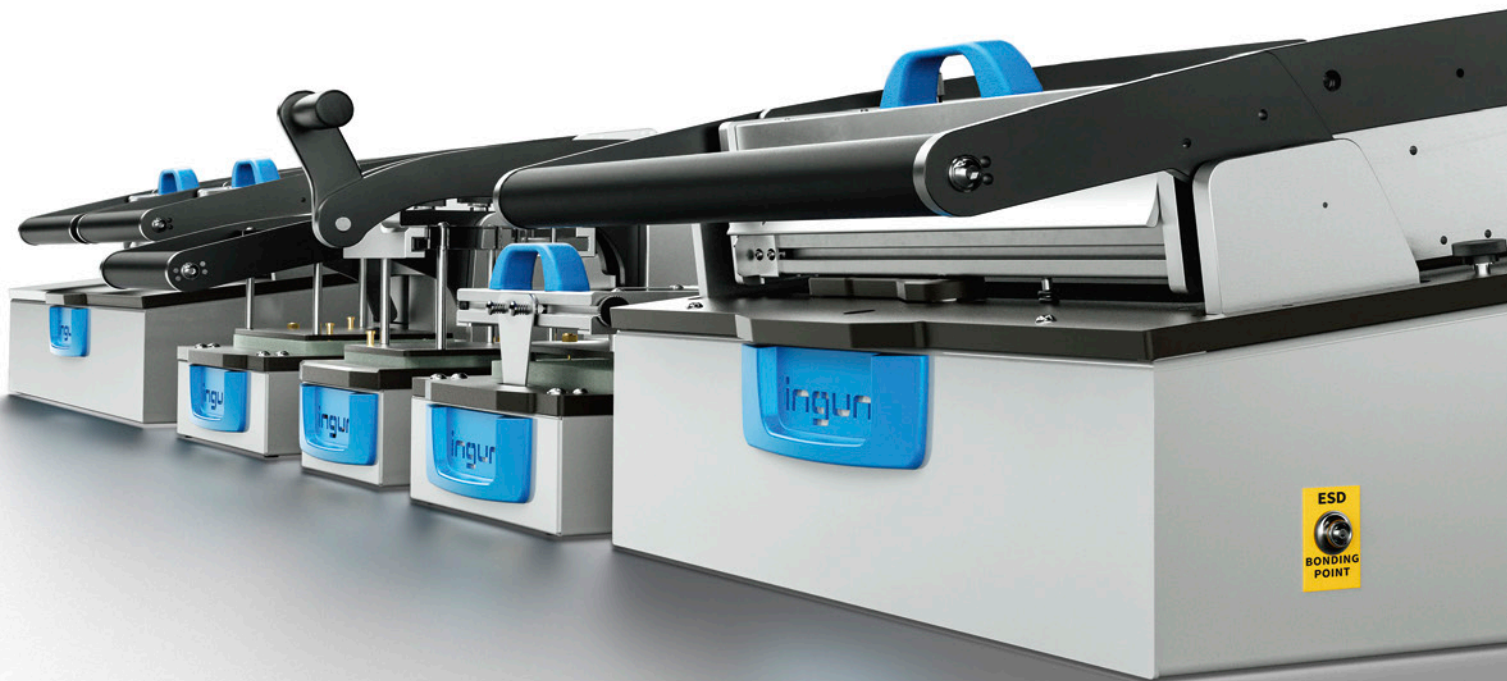

# Manual test fixture

## Series MA xxx | MA xxxx

Manual test fixtures are subdivided into two series, the **MA xxx series** and the **MA xxxx series** with the MA 20xx, MA 21xx and MA 32xx series, both available without and with test system interface. They differ in terms of their use, the maximum permissible contact force, the parallel stroke, and the size, and the life span.

There are **interchangeable test fixtures** or **stand-alone test fixtures**. Both versions are operated with a **exchangeable kit** that can be quickly exchanged when used with the interchangeable test fixture or permanently installed in the stand-alone test fixture.

The parallel **contacting stroke** is generated manually by the operator, who should observe the lowest clamping forces. The pressure frame unit of the test adapter MA 160 is pressed vertically and the handle of test fixtures MA 2xx, MA 3xx and MA xxxx is used to close the fixtures.

Thanks to the modular design, you have the opportunity to expand the functionality and ease of use of the MA xxxx-test fixture and the exchangeable kits ATS MAxx with **functional units as required**. For more information, see pages 64 to 77.

MA xxx series		MA xxxx series			Usable area (W x D mm)
Exchangeable test fixtures for single testing		MA 20xx Stand-alone test fixtures for serial testing	MA 21xx Exchangeable test fixtures for serial testing	MA 32xx Exchangeable test fixtures for mass testing	
1: max. 300 N *	2: max. 20 mm	1: max. 2.000 N *	1: max. 2.000 N *	1: max. 2.000 N *	
3: ~ 300.000 *		2: 15 mm	2: 15 mm	2: 22 mm	
		3: ~ 500.000 *	3: ~ 500.000 *	3: ~ 2.000.000 *	
MA 160 (4: 160 x 100 mm)		MA 2011	MA 2109	MA 3211	150 x 170
MA 260 (4: 160 x 100 mm)		MA 2012	MA 2111	MA 3212	150 x 240
MA 350 (4: 100 x 90 mm)		MA 2013	MA 2112	MA 3213	285 x 240
MA 360 (4: 160 x 100 mm)		MA 2013T	MA 2113	MA 3213T	440 x 310
		MA 2014	MA 2113T	MA 3214	2x 150 x 240
			MA 2114		540 x 310

Exchangeable kits ATS MAxxx series		Exchangeable kits ATS MAxx series		
Standard	ESD	Standard	ESD	Radio frequency

Functional units for MA xxxx and ATS MAxx series

1 = contact force  
 2 = parallel stroke  
 3 = life span  
 4 = effective area (MA xxx series)  
 \* = laboratory conditions

Manual test fixture series MA xxx | MA xxxx

The pressure frame unit is closed manually using the handle. The parallel contacting stroke is performed once the pressure frame unit is in the horizontal position.

For the test fixtures MA 350, MA 360 and the MA xxxx-series, the weight of the pressure frame unit is balanced out with at least one **gas pressure spring** so that the pressure frame unit remains in the open state. Note that the gas pressure springs have a typical life span of approx. 50,000 load cycles and should be replaced at regular

intervals in order to fully preserve the functionality of the test fixtures.

After loosening the quick release screw, which is positioned in the front of the mounting plate, the **interior** of the test fixture of the MA xxxx series can be easily reached by opening the drive unit. This makes it possible to open the test fixture in the contacted position, e.g. to adjust installed additional electronics, or to reach spring-loaded test probes in contact with a measurement probe (debugging).

**MA xxx-test fixture**

Operating elements and functional units

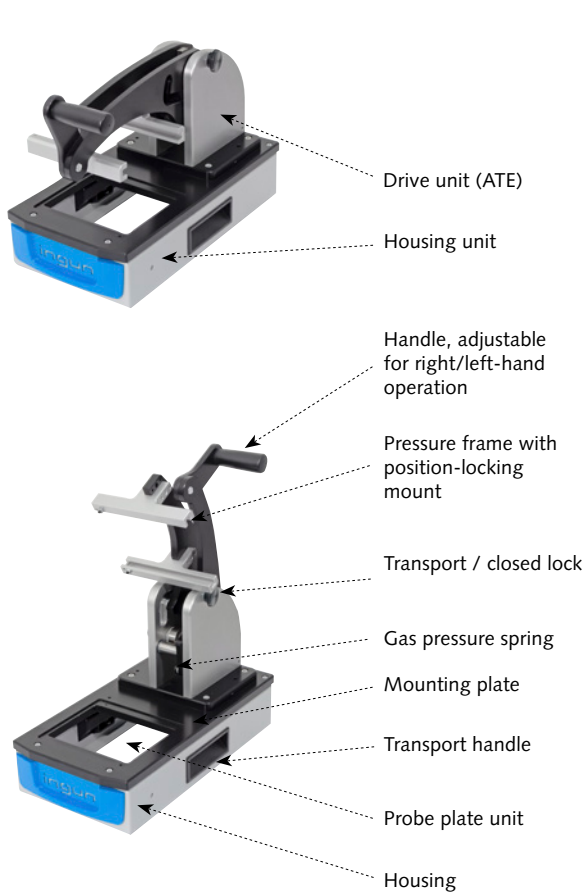

**MA xxxx-test fixture**

Operating elements and functional units

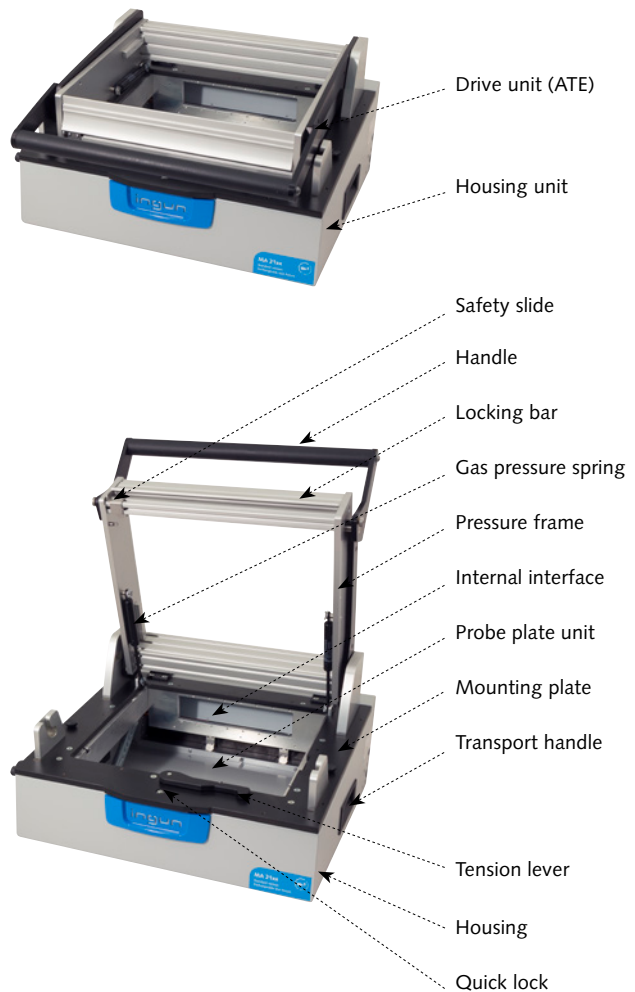

# Manual test fixture

## Exchangeable kits (ATS)

Exchangeable kits for manual test fixtures are available in **standard, ESD, radio frequency, and rigid pin** versions, which can be changed quickly, without tools and without readjustment when used with interchangeable test fixtures. They are divided into exchangeable kits **ATS MAxxx** for test fixtures in the MA xxx series and exchangeable kits **ATS MAxx** for test fixtures in the MA xxxx series.

Depending on the type of exchangeable kits, the use is specified as follows:

- **Standard exchangeable kits** are used in the testing of electronic units such as printed circuit boards (PCBs) which do not require special protective measures or that do not have to take into account extended conditions in terms of contacting.
- **ESD exchangeable kits** are used to test ESD sensitive electronic units to protect them from damage due to electrostatic discharge. For the safe dissipation of electrostatic charges, specialised ESD-compliant materials and coatings are used, which in accordance with DIN EN 61340-5-1 have a surface resistance between  $\geq 10^5$  and  $< 10^{11} \Omega$ .

- **Radio frequency exchangeable kits** are used when testing high-sensitivity RF modules to measure radio frequency signals without interference. Excellent screening attenuation is achieved in the frequency range up to 6 GHz, and the RF functional unit is reliably shielded from interference signals.
- **Rigid pin exchangeable kits** are used to test small test points in small grids and contact them with a high spring force precisely and reliably. The contacting is performed with rigid test probes (rigid pins), which are guided in a stack of plates and are deflected by a certain angle. Each rigid pin is assigned a spring-loaded test probe with which the spring force is transmitted to the test point. Using specialised software, the deflection of the rigid needles is determined specifically for the DUT. The calculation is performed at INGUN. Test points with a diameter of 0.30 mm can be contacted within a minimum grid of 0.50 mm (specifications without PCB tolerances, when customised by INGUN). Smaller test grids are possible on request.

We recommend the use of VG strips for the **internal interface** of MA xxx test fixtures. The internal interface of MA xxxx test fixtures is equipped with interface blocks.

Exchangeable kits (ATS)	ATS versions				RF interface	Internal interface	
	Standard	ESD	Radio frequency	Rigid pin			
<b>ATS MAxxx</b>			-	-	-		<b>VG strips (FB)</b>
<b>ATS MAxx (with internal interface)</b>					<b>EMC-compatible RF transfers (only RF version)</b>		<b>Interface blocks (SB)</b>
<b>ATS MAxx (without internal interface)</b>				-	<b>EMC-compatible RF transfers (only RF version)</b>	-	-
<b>Standard customisation</b> <b>Contact area:</b> <b>Minimum grid:</b>	$\varnothing = 0.60 \text{ mm}$ 1.0 mm	$\varnothing = 0.60 \text{ mm}$ 1.0 mm	$\varnothing = 0.60 \text{ mm}$ 1.0 mm	$\varnothing = 0.30 \text{ mm}$ 0.50 mm	(without PCB tolerances, when customised by INGUN)		



The exchangeable kits consist of the **probe plate unit** and the **pressure frame unit**. The probe plate unit includes the pressure plate, the probe plate, the wiring protection plate and, depending on the version, an internal interface that is modularly loaded with interface blocks, as required. The pressure frame unit includes the pressure frame unit plate and the leading pushrod.

For storage or transport, the probe plate unit and the pressure frame unit can be firmly screwed together with stacking screws to form a unit with a protected probe field. The exchangeable kits are ready for use without readjustment and, except for the high frequency version, are delivered unassembled which enables immediate DUT-specific processing.

**ATS MAxx exchangeable kits**

Operating elements and functional units

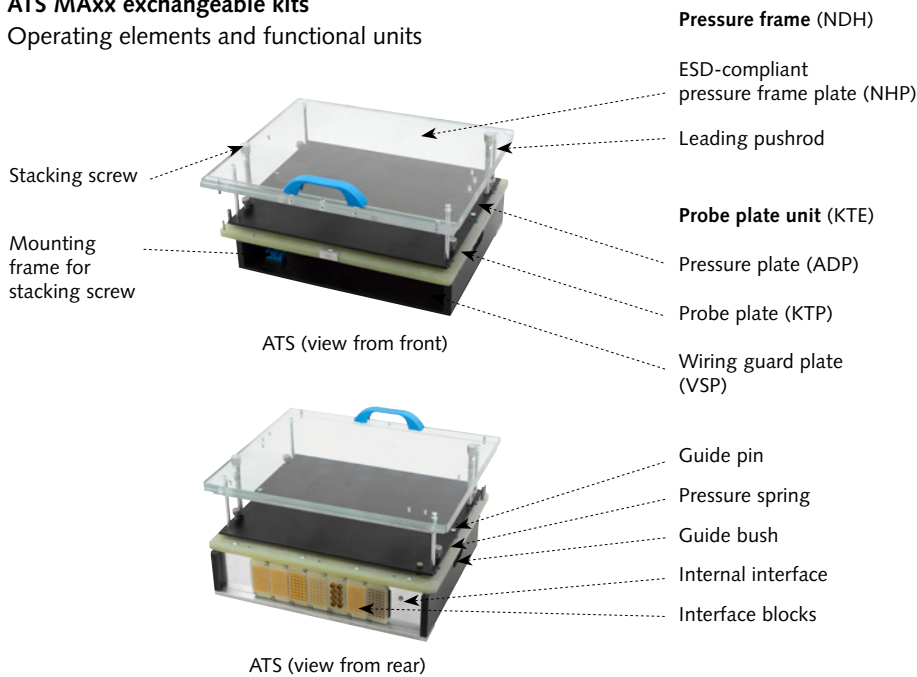

**Signal transmission with interface blocks**

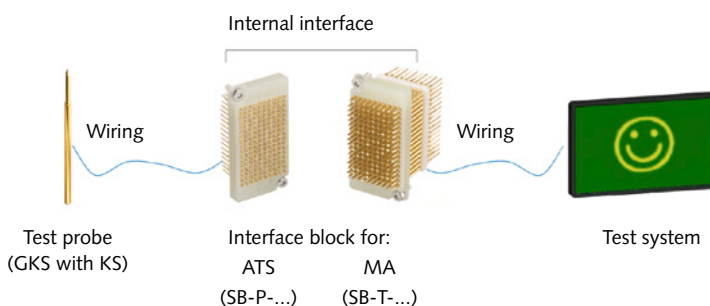

**Manual test fixtures**

MA xxx	23
MA xxxx	29
ATS MAxx/HF (Radio frequency)	58
FB (Functional units)	64

**Note**  
See pages 56 to 57 for product overview.

# Manual test fixture Performance spectrum

## Performance spectrum of manual test fixture MA xxx and MA xxxx in overview

PRICE

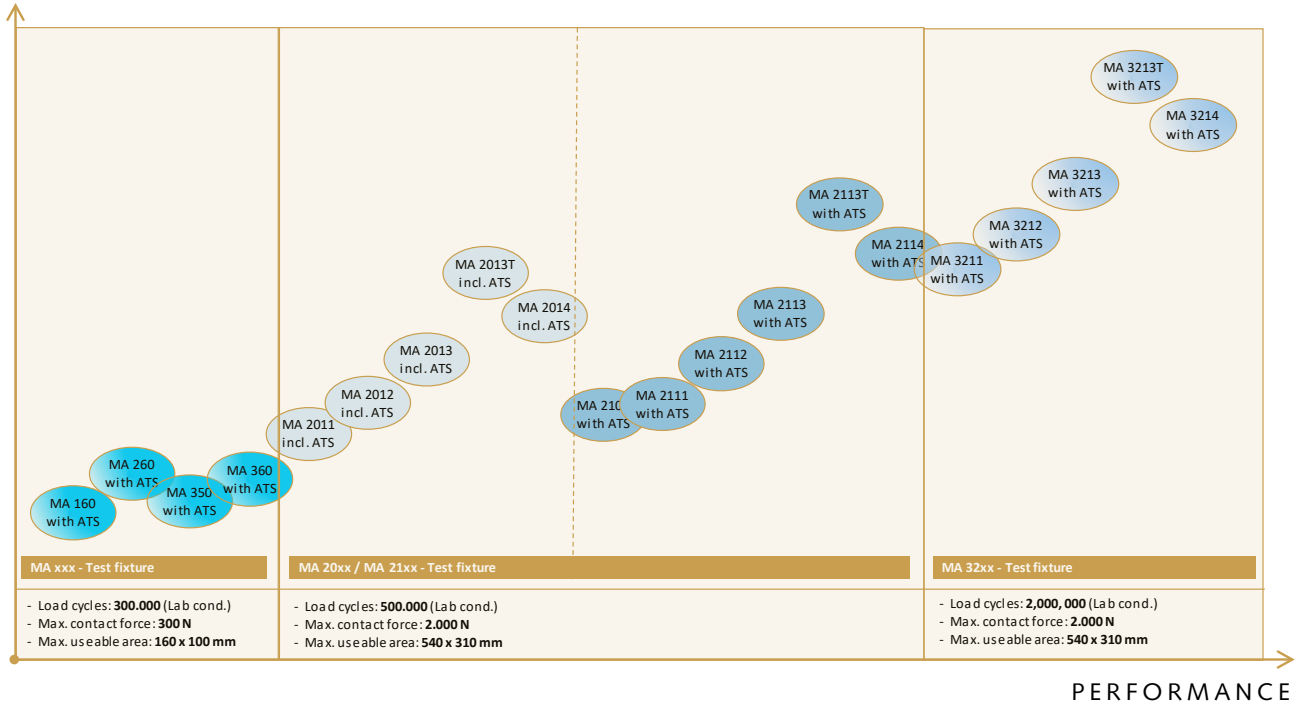

PERFORMANCE

### MA xxx

- Batch testing
- Interchangeable test fixture
- Max. load cycles
- Max. contact force
- Max. useable area

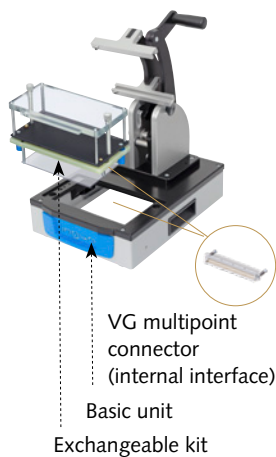

### MA 20xx

- Series testing
- Stand-alone test fixture
- Max. load cycles
- Max. contact force
- Max. useable area



### MA 21xx

- Series testing
- Interchangeable test fixture
- Max. load cycles
- Max. contact force
- Max. useable area

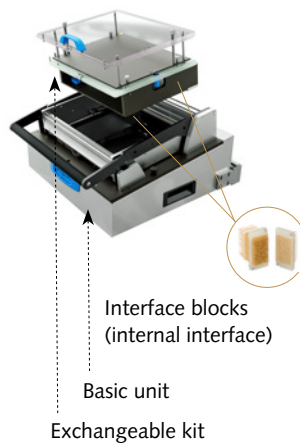

### MA 32xx

- Mass testing
- Interchangeable test fixture
- Max. load cycles
- Max. contact force
- Max. useable area

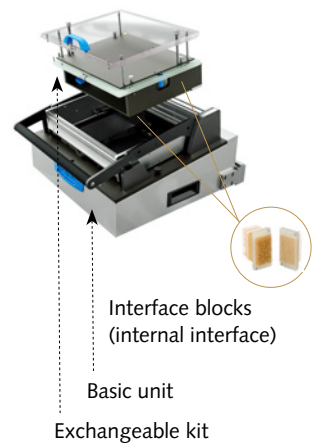

# MA xxx

## Manual interchangeable kit test fixture for batch testing



### Usage

Test fixtures in the MA xxx series are suitable for contacting or flash programming of electronic units such as printed circuit boards (PCBs) with moderate quantities (batch testing) and a large number of versions. The test fixtures are designed as an interchangeable kit system, are connected to an existing test system, and are operated with exchangeable kits that are specially designed for the electronic functional unit to be tested.

### Features

- Interchangeable kit system
- Laterally open pressure frame unit
- Stackable, open bottom, fully removable housing
- Freely definable internal interface
- Exchangeable kits available as standard and ESD version, can be set up quickly without tools and can be used without readjustment
- Pressure frame unit and probe plate can be screwed with stacking screws, to form a unit with protected probe field (storage/transport)

### Life span

- 300,000 load cycles (laboratory conditions)  
The life span is determined in the laboratory using fully automatic, computer-controlled endurance test stations under full load. Since the life span depends on many different factors and in particular on the individual test application, INGUN does not guarantee the actual duration of use in the test field.

### Internal interface

For the unloaded internal interface, we recommend the use of VG strips (see page 205).

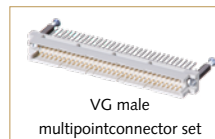

### Customisation

INGUN provides customising documents for customisation. The exchangeable kits are to be customised according to the customising guidelines **info 1591**.



Starter kits for customising on site and other customising accessories, such as pushrods, PCB support pins, tooling pins, pre-centring pins, or marking units and test plugs, can be found from page 153 onwards.

### MA xxx - Test fixture

MA 160	24
MA 260	25
MA 350	26
MA 360	27

### ATS MAxxx - Exchangeable kits

ATS MA160	24
ATS MA160/ESD	24
ATS MA260	25
ATS MA260/ESD	25
ATS MA350	26
ATS MA350/ESD	26
ATS MA360	27
ATS MA360/ESD	27

### ATE MAxxx - Drive unit

ATE MA260	25
ATE MA350	26
ATE MA360	27

### Note

See page 28 for overview and comparison table.

# MA 160

Manual interchangeable test fixture for batch testing

Series: MA xxx  
 Contact force: 100 N  
 Parallel stroke: 15 mm  
 Maximum usable area: 160 x 100 mm  
 Load cycles: 300,000 (laboratory conditions)



## Basic unit

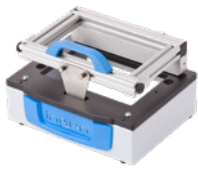

MA 160/F

## Exchangeable kits

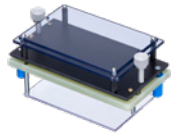

ATS MA160

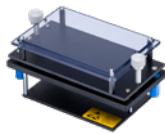

ATS MA160/ESD

## Accessories

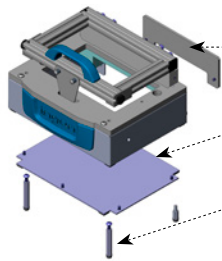

Rear panel  
FB-RWA-MA160

Bottom plate  
FB-BOP-MA160

Adjustable feet  
FB-STF-MA160

## Features

- Low-cost version for PCBs with low components, to approx. 18 mm height
- Single-sided contacting from bottom side

## Technical specifications

### Basic unit

- Outer dimensions, closed (W x D x H):
  - MA 160/F: approx. 230 x 185 x 155 mm
- Outer dimensions, open (W x D x H):
  - MA 160/F: approx. 230 x 270 x 285 mm
- Pressure frame unit opening angle: approx. 105 °
- Pressure frame unit clamping force: approx. 130 N (at full load)
- Free accessibility (D x H): approx. 105 x > 150 mm

### Exchangeable kit

- Usable area ATS (W x D):
  - ATS MA160: approx. 160 x 100 mm
  - ATS MA160/ESD: approx. 160 x 100 mm
- Free height above PCB: approx. 18 mm
- Pushrod length: 20 mm
- GKS installation height, bottom: 10.5 mm
- GKS theoretical working stroke: 3 mm (bottom)

### General

- Permissible test voltage: 25 V AC / 60 V DC
- Operating temperature range: + 10 °C to + 60 °C

### Internal interface

- ATS MA160(/ESD):

freely definable VG male multipoint connector set (64 | 96-pole) recommended

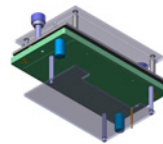

(64-pole)



(96-pole)

## Note:

You will find suitable VG male multipoint connectors for setting up the interface on page 205.

## Ordering information

Basic unit		
Part no.:	44430	MA 160/F
		Manual interchangeable kit test fixture
Exchangeable kits		
Part no.:	28385-KIT	ATS MA160
		Standard exchangeable kit
Part no.:	30800-KIT	ATS MA160/ESD
		ESD exchangeable kit
Accessories		
Part no.:	51320	FB-RWA-MA160
		Rear panel with 120 x 20 mm opening to feed through cables
Part no.:	51705	FB-BOP-MA160
		Bottom plate
Part no.:	52630	FB-STF-MA160
		Adjustable feet (4 pieces) for operation without housing

Parts with the ending "-KIT" are delivered unassembled. This enables immediate DUT-specific processing.

### Basic unit



MA 260/F

### Exchangeable kits

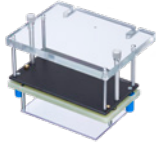

ATS MA260

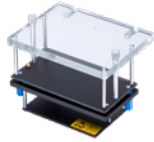

ATS MA260/ESD

### Accessories

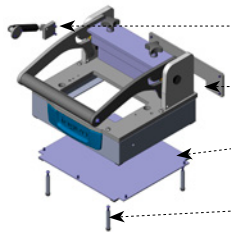

- Gas pressure spring  
FB-GDF-MA260
- Rear panel  
FB-RWA-MA260
- Bottom plate  
FB-BOP-MA260
- Adjustable feet  
FB-STF-MA2xx/3xx

### Drive unit



ATE MA 260

Also separately available.

### Features

- High stability against unbalanced loads
- Single-sided or double-sided contacting

### Technical specifications

#### Basic unit

- Outer dimensions, closed (W x D x H):  
- MA 260/F: approx. 260 x 300 x 200 mm
- Outer dimensions, open (W x D x H):  
- MA 260/F: approx. 260 x 260 x 320 mm
- Pressure frame unit opening angle: approx. 50 °
- Pressure frame unit clamping force: approx. 60 N (at full load)
- Free accessibility (D x H): approx. 105 x 65 mm

#### Exchangeable kit

- Usable area ATS (W x D):
- ATS MA260: approx. 160 x 100 mm
- ATS MA260/ESD: approx. 160 x 100 mm
- Free height above PCB: approx. 58 mm
- Pushrod length: 60 mm
- GKS installation height, bottom: 10.5 mm
- GKS installation height, top: 16.0 mm
- GKS theoretical working stroke: 3 mm (bottom), 3.5 mm (top)

#### General

- Permissible test voltage: 25 V AC / 60 V DC
- Operating temperature range: + 10 °C to + 60 °C

#### Internal interface

- ATS MA260(/ESD):

freely definable,  
 VG-male multipoint connector set (64 | 96-pole)  
 recommended

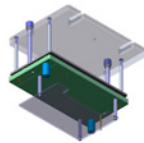

(64-pole)



(96-pole)

### Note:

You will find suitable VG male multipoint connectors for setting up the interface on page 205.

## Ordering information

Basic unit		
Part no.:	40600	MA 260/F
		Manual interchangeable kit test fixture
Exchangeable kits		
Part no.:	41220-KIT	ATS MA260
		Standard exchangeable kit
Part no.:	41225-KIT	ATS MA260/ESD
		ESD exchangeable kit
Accessories		
Part no.:	48460	FB-GDF-MA260
		Gas pressure spring with 50 N for securing open pressure frame unit
Part no.:	51703	FB-RWA-MA260
		Rear panel with 120 x 20 mm opening to feed through cables
Part no.:	51706	FB-BOP-MA260
		Bottom plate
Part no.:	51860	FB-STF-MA2xx/3xx
		Adjustable feet (4 pieces) for operation without housing
Drive unit		
Part no.:	44120	ATE MA260
		Drive unit

Parts with the ending "-KIT" are delivered unassembled. This enables immediate DUT-specific processing.



# MA 350

Manual interchangeable test fixture for batch testing

Series: MA xxx  
 Contact force: 300 N  
 Parallel stroke: 20 mm  
 Maximum usable area: 100 x 90 mm  
 Load cycles: 300,000 (laboratory conditions)



## Basic unit



MA 350/F

## Exchangeable kits

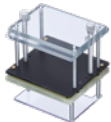

ATS MA350

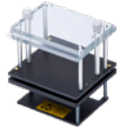

ATS MA350/ESD

## Accessories

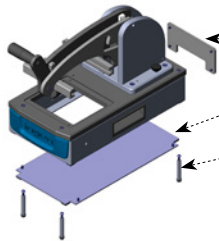

- Rear panel  
FB-RWA-MA350
- Bottom plate  
FB-BOP-MA350
- Adjustable feet  
FB-STF-MA2xx/3xx

## Drive unit



ATE MA350

Also available separately.

## Features

- Generously designed free accessibility
- Gas pressure spring with 100 N to secure the open pressure frame unit
- Adjustable handle for right/left-hand operation
- Stop-position pressure frame unit mount
- Single-sided or double-sided contacting

## Technical specifications

### Basic unit

- Outer dimensions, closed (W x D x H):  
 - MA 350/F: approx. 170 x 365 x 251 mm
- Outer dimensions, open (W x D x H):  
 - MA 350/F: approx. 170 x 330 x 381 mm
- Pressure frame unit opening angle: approx. 65 °
- Pressure frame unit clamping force: approx. 30 N (at full load)
- Free accessibility (D x H): approx. 120 x 150 mm

### Exchangeable kit

- Usable area ATS (W x D):  
 - ATS MA350: approx. 100 x 90 mm  
 - ATS MA350/ESD: approx. 100 x 90 mm
- Free height above PCB: approx. 58 mm
- Pushrod length: 60 mm
- GKS installation height, bottom: 10.5 mm
- GKS installation height, top: 16.0 mm
- GKS theoretical working stroke: 3 mm (bottom), 3.5 mm (top)

### General

- Permissible test voltage: 25 V AC / 60 V DC
- Operating temperature range: + 10 °C to + 60 °C

### Internal interface

- ATS MA350(/ESD):

Freely definable, VG male multipoint connector set (64 | 96-pole) recommended

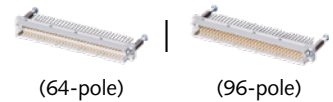
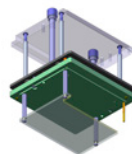

## Note:

You will find suitable VG male multipoint connectors for setting up the interface on page 205.

## Ordering information

Basic unit		
Part no.:	46100	MA 350/F
		Manual interchangeable kit test fixture
Exchangeable kits		
Part no.:	46480-KIT	ATS MA350
		Standard exchangeable kit
Part no.:	46490-KIT	ATS MA350/ESD
		ESD exchangeable kit
Accessories		
Part no.:	51768	FB-RWA-MA350
		Rear panel with 80 x 20 mm opening to feed through cables
Part no.:	51710	FB-BOP-MA350
		Bottom plate
Part no.:	51860	FB-STF-MA2xx/3xx
		Adjustable feet (4 pieces) for operation without housing
Drive unit		
Part no.:	41570	ATE MA350
		Drive unit

Parts with the ending "-KIT" are delivered unassembled. This enables immediate DUT-specific processing.

### Basic unit



MA 360/F

### Exchangeable kits

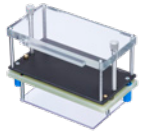

ATS MA360

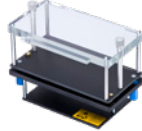

ATS MA360/ESD

### Accessories

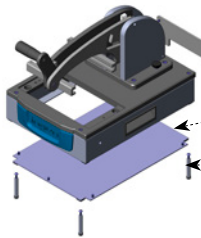

- Rear panel  
FB-RWA-MA360
- Bottom plate  
FB-BOP-MA360
- Adjustable feet  
FB-STF-MA2xx/3xx

### Drive unit



ATE MA360

Also available separately.

### Features

- Generously designed free accessibility and expanded usable area
- Gas pressure spring with 100 N to secure the open pressure frame
- Adjustable handle for right/left-hand operation
- Stop-position pressure frame mount
- Single-sided or double-sided contacting

### Technical specifications

#### Basic unit

- Outer dimensions, closed (W x D x H):
  - MA 360/F: approx. 230 x 365 x 251 mm
- Outer dimensions, open (W x D x H):
  - MA 360/F: approx. 230 x 330 x 381 mm
- Pressure frame unit opening angle: approx. 65 °
- Pressure frame unit clamping force: approx. 30 N (at full load)
- Free accessibility (D x H): approx. 120 x 150 mm

#### Exchangeable kit

- Usable area ATS (W x D):
  - ATS MA360: approx. 160 x 100 mm
  - ATS MA360/ESD: approx. 160 x 100 mm
- Free height above PCB: approx. 58 mm
- Pushrod length: 60 mm
- GKS installation height, bottom: 10.5 mm
- GKS installation height, top: 16.0 mm
- GKS theoretical working stroke: 3 mm (bottom), 3.5 mm (top)

#### General

- Permissible test voltage: 25 V AC / 60 V DC
- Operating temperature range: + 10 °C to + 60 °C

#### Internal interface

- ATS MA360(/ESD):

Freely definable, VG male multipoint connector set (64 | 96-pole) recommended

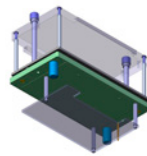

(64-pole)



(96-pole)





### Note:

You will find suitable VG male multipoint connectors for setting up the interface on page 205.

## Ordering information

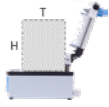
Basic unit		
Part no.:	45650	MA 360/F
		Manual interchangeable kit test fixture
Exchangeable kits		
Part no.:	45669-KIT	ATS MA360
		Standard exchangeable kit
Part no.:	46200-KIT	ATS MA360/ESD
		ESD exchangeable kit
Accessories		
Part no.:	51707	FB-RWA-MA360
		Rear panel with 120 x 20 mm opening to feed through cables
Part no.:	51708	FB-BOP-MA360
		Bottom plate
Part no.:	51860	FB-STF-MA2xx/3xx
		Adjustable feet (4 pieces) for operation without housing
Drive unit		
Part no.:	45668	ATE MA360
		Drive unit

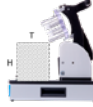
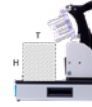
Parts with the ending "-KIT" are delivered unassembled. This enables immediate DUT-specific processing.

Description	MA 160/F	MA 260/F	MA 350/F	MA 360/F
MA part number	44430	40600	46100	45650
ATS MA part number	28385-KIT	41220-KIT	46480-KIT	45669-KIT
ATS MA/ ESD part number	30800-KIT	41225-KIT	46490-KIT	46200-KIT
ATS MA part number	-	44120	41570	45668
GDF MA part number	-	48460	-	-
RWA MA part number	51320	51703	51768	51707
BOP MA part number	51705	51706	51710	51708
STF MA part number	52630	51860	51860	51860
Maximum contact force	100 N	300 N	300 N	300 N
Parallel stroke	15 mm	15 mm	20 mm	20 mm
Outer dim., closed (W x D x H mm)	230 x 185 x 155	260 x 300 x 200	170 x 365 x 251	230 x 365 x 251
Outer dim., open (W x D x H mm)	230 x 270 x 285	260 x 260 x 320	170 x 330 x 381	230 x 330 x 381
Usable area ATS MA (W x D mm)	160 x 100	160 x 100	100 x 90	160 x 100
Usable area ATS MA/ESD (W x D mm)	160 x 100	160 x 100	100 x 90	160 x 100
Pressure frame unit opening angle	105 °	50 °	65 °	65 °
Pressure frame unit clamping force (at full load)	130 N	60 N	30 N	30 N
Free accessibility (D x H mm)	105 x > 150 	105 x 65 	120 x 150 	120 x 150 
Free overall height above PCB	18 mm	58 mm	58 mm	58 mm
Pushrod length	20 mm	60 mm	60 mm	60 mm
GKS installation height, bottom	10.5 mm	10.5 mm	10.5 mm	10.5 mm
GKS installation height, top	-	16.0 mm	16.0 mm	16.0 mm
GKS theoretical working stroke, bottom	3 mm	3 mm	3 mm	3 mm
GKS theoretical working stroke, top	-	3.5 mm	3.5 mm	3.5 mm
Max. permissible test voltage (protected extra-low voltage) 	25 V AC / 60 V DC	25 V AC / 60 V DC	25 V AC / 60 V DC	25 V AC / 60 V DC
Operating temperature range	+ 10 °C to + 60 °C	+ 10 °C to + 60 °C	+ 10 °C to + 60 °C	+ 10 °C to + 60 °C
MA weight	1.6 kg	3.6 kg	4.5 kg	4.9 kg
ATS MA weight	1.0 kg	1.3 kg	0.8 kg	1.1 kg
ATS MA/ESD weight	1.0 kg	1.3 kg	0.8 kg	1.1 kg
ATE MA weight	-	3.3 kg	2.6 kg	3.0 kg

# MA 20xx

## Manual stand-alone test fixture for series testing

Size
 <p>MA 2011</p>
 <p>MA 2012</p>
 <p>MA 2013</p>
 <p>MA 2013T</p>
 <p>MA 2014</p>

**Usage**

Test fixtures of the MA 20xx series are suitable for contacting electronic units such as printed circuit boards (PCBs) with medium quantities (series testing) and a small number of versions. The test fixtures are designed as a single system without an internal interface, are connected to an existing test system, and are operated with permanently installed exchangeable kits that are specially designed for the electronic unit to be tested.

**Features**

- Single system without internal interface
- High contact force of up to 2,000 N
- Energy-saving, shock-absorbing opening mechanism
- Permanently mounted exchangeable kit
- Available with and without test system interface

**Life span**

- 500,000 load cycles (laboratory conditions)  
 The life span is determined in the laboratory using fully automatic, computer-controlled endurance test stations under full load. Since the life span depends on many different factors and in particular on the individual test application, INGUN does not guarantee the actual duration of use in the test field.

**Functional units**

Stiffener bars and numerous other functional units for extension of functionality as required can be found from page 64 onwards.



**Customisation**

INGUN provides customising documents for customisation. The exchangeable kits are to be customised according to the customising guidelines **info 1317**.



Starter kits for customising on site and other customising accessories, such as pushrods, PCB support pins, tooling pins, pre-centring pins, marking units, and test plugs, can be found from page 153 onwards.

**MA 20xx - Test fixture**

MA 2011	30
MA 2012	30
MA 2013	30
MA 2013T	30
MA 2014	30

**Note**

See pages 32 to 33 for overview and comparison table.

# MA 20xx

Manual stand-alone test fixture for series testing without test system interface

Series: MA xxxx

Contact force: 2,000 N

Parallel stroke: 15 mm

Load cycles: 500,000 (laboratory conditions)

Test fixture incl. exchangeable kit ATS MAxx with **standard housing**

Test fixture incl. exchangeable kit ATS MAxx with **tall housing**

## Features

- Fully closed pressure frame
- Test fixture without internal interface, incl. exchangeable kit ATS MAxx
- Single-sided, double-sided, dual-stage contacting

## Technical specifications

### Basic unit

- Outer dimensions, closed (W x D x H):
  - MA 2011/D/H: approx. 320 x 515 x 270 mm
  - MA 2012/D/H: approx. 492 x 515 x 270 mm
  - MA 2012/D/H/HG: approx. 492 x 515 x 370 mm
  - MA 2012/D/H/HF: approx. 492 x 515 x 270 mm
  - MA 2013/D/H: approx. 647 x 584 x 270 mm
  - MA 2013/D/H/HG: approx. 647 x 584 x 370 mm
  - MA 2013T/D/H: approx. 647 x 533 x 270 mm
  - MA 2014/D/H: approx. 745 x 584 x 270 mm
- Outer dimensions, open (W x D x H):
  - MA 2011/D/H: approx. 320 x 461 x 583 mm
  - MA 2012/D/H: approx. 492 x 461 x 583 mm
  - MA 2012/D/H/HG: approx. 492 x 461 x 688 mm
  - MA 2012/D/H/HF: approx. 492 x 461 x 583 mm
  - MA 2013/D/H: approx. 647 x 532 x 656 mm
  - MA 2013/D/H/HG: approx. 647 x 532 x 750 mm
  - MA 2013T/D/H: approx. 647 x 533 x 591 mm
  - MA 2014/D/H: approx. 745 x 532 x 650 mm
- Pressure frame unit opening angle: approx. 75 °
- Pressure frame unit clamping force: approx. 120 N (at full load)

### Interchangeable kit

- Usable area test fixture MA 20xx (W x D):
  - MA 2011/D/H: approx. 150 x 240 mm
  - MA 2012/D/H(HG): approx. 285 x 240 mm
  - MA 2012/D/H/HF: approx. 215 x 180 mm
  - MA 2013/D/H(HG): approx. 440 x 310 mm
  - MA 2013T/D/H: approx. 2x 150 x 240 mm
  - MA 2014/D/H: approx. 540 x 310 mm
- Free height above PCB: approx. 58 mm
- Pushrod length: 60 mm
- GKS installation height, bottom: 10.5 mm
- GKS installation height, top: 16.0 mm
- GKS installation height 2-stage, bottom: 10.5 | 16.0 mm
- GKS theoretical working stroke: 3 mm (bottom), 3.5 mm (top)

### General

- Operating temperature range: + 10 °C to + 60 °C

### \* MA 2012/D/H/HF

- Dual-stage contacting is not possible with the MA 2012/D/H/HF.
- You will find further information about RF exchangeable kits starting on page 58.



MA 2011/D/H



MA 2012/D/H

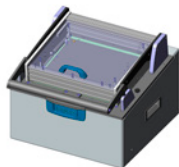

MA 2012/D/H/HG

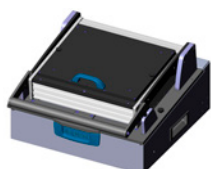

MA 2012/D/H/HF (\*)



MA 2013/D/H

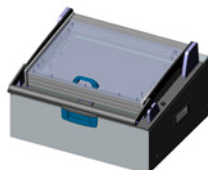

MA 2013/D/H/HG

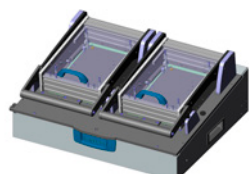

MA 2013T/D/H

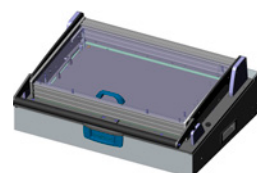







MA 2014/D/H

## Ordering information

Manual stand-alone test fixture (including exchangeable kit without internal interface)			
Part no.:	48590	MA 2011/D/H	Manual stand-alone test fixture (incl. ATS MA11 - Part 45900-KIT)
Part no.:	48530	MA 2012/D/H	Manual stand-alone test fixture (incl. ATS MA12 - Part 45904-KIT)
Part no.:	101930	MA 2012/D/H/HG	Manual stand-alone test fixture (incl. ATS MA12 – Part 45904-KIT)
Part no.:	54818	MA 2012/D/H/HF (*)	Manual RF stand-alone test fixture (incl. ATS MA12/HF - Part 54012)
Part no.:	48620	MA 2013/D/H	Manual stand-alone test fixture (incl. ATS MA13 - Part 45980-KIT)
Part no.:	100720	MA 2013/D/H/HG	Manual stand-alone test fixture (incl. ATS MA13 - Part 45980-KIT)
Part no.:	100985	MA 2013T/D/H	Manual tandem stand-alone test fixture (incl. 2x ATS MA11 - Part 45900-KIT)
Part no.:	100690	MA 2014/D/H	Manual stand-alone test fixture (incl. ATS MA14 - Part 45985-KIT)

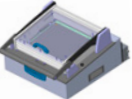
The delivery of the manual stand-alone test fixture MA 20xx contains two separate units, 1x basic unit GG MA 20xx and 1x replacement set ATS MAxx (not assembled, except ATS MA12/HF).



Test system	Part number   Description   Outer dimensions (W x D x H)	
	MA 2012 (incl. ATS MA12 - 45904-KIT)	MA 2013 (incl. ATS MA13 - 45980-KIT)
<b>TERADYNE TESTSTATION GR 2270/71</b>	 <p><b>53350</b>                      MA 2012/D/H/GR 2270/71                      approx. 501 x 548 x 262 mm (closed)                      approx. 501 x 494 x 576 mm (open)</p>	
<b>Dr. ESCHKE ROHDE &amp; SCHWARZ Pylon</b>	 <p><b>51865</b>                      MA 2012/D/H/Pylon                      approx. 501 x 548 x 262 mm (closed)                      approx. 501 x 494 x 576 mm (open)</p>	 <p><b>53230</b>                      MA 2013/D/H/Pylon                      approx. 654 x 618 x 262 mm (closed)                      approx. 654 x 564 x 649 mm (open)</p>
<b>VIRGINIA PANEL VPC-G12-12</b>	 <p><b>59830</b>                      MA 2012/D/H/VPC-G12-12                      approx. 493 x 565 x 262 mm (closed)                      approx. 493 x 510 x 576 mm (open)</p>	 <p><b>57325</b>                      MA 2013/D/H/VPC-G12-12                      approx. 654 x 618 x 262 mm (closed)                      approx. 654 x 564 x 649 mm (open)</p>
<b>VIRGINIA PANEL VPC-G12x-18</b>	 <p><b>53388</b>                      MA 2012/D/H/VPC-G12x-18                      approx. 493 x 548 x 262 mm (closed)                      approx. 493 x 494 x 576 mm (open)</p>	 <p><b>53390</b>                      MA 2013/D/H/VPC-G12x-18                      approx. 649 x 618 x 262 mm (closed)                      approx. 649 x 564 x 649 mm (open)</p>

Description	MA 2011/ D/H	MA 2012/ D/H	MA 2012/ D/H/HG	MA 2012/ D/H/HF	MA 2013/ D/H	MA 2013/ D/H/HG	MA 2013T/ D/H
<b>Part number MA</b>	48590	48530	101930	54818	48620	100720	100985
<b>Version</b>	Incl. ATS MA11 (Part. 45900-KIT)	Incl. ATS MA12 (Part. 45904-KIT)	Incl. ATS MA12 (Part. 45904-KIT)	Incl. ATS MA12/HF (Part. 54012)	Incl. ATS MA13 (Part. 45980-KIT)	Incl. ATS MA13 (Part. 45980-KIT)	Incl. 2x ATS MA11 (Part. 45900-KIT)
	Without test system interface	Without test system interface	Without test system interface	Without test system interface	Without test system interface	Without test system interface	Tandem, without test system interface
<b>Maximum contact force</b>	2.000 N	2.000 N	2.000 N	2.000 N	2.000 N	2.000 N	2.000 N
<b>Parallel stroke</b>	15 mm	15 mm	15 mm	15 mm	15 mm	15 mm	15 mm
<b>Outer dim, closed (W x D x H mm)</b>	320 x 515 x 270	492 x 515 x 270	492 x 515 x 370	492 x 515 x 270	647 x 584 x 270	647 x 548 x 370	647 x 533 x 270
<b>Outer dim., open (W x D x H mm)</b>	320 x 461 x 583	492 x 461 x 583	492 x 461 x 688	492 x 461 x 583	647 x 532 x 656	647 x 532 x 750	647 x 533 x 591
<b>Usable area (W x D mm)</b>	150 x 240	285 x 240	285 x 240	215 x 180	440 x 310	440 x 310	2x 150 x 240
<b>Pressure frame opening angle</b>	75 °	75 °	75 °	75 °	75 °	75 °	75 °
<b>Pressure frame clamping force (at full load)</b>	120 N	120 N	120 N	120 N	120 N	120 N	120 N
<b>Free overall height above PCB</b>	58 mm	58 mm	58 mm	58 mm	58 mm	58 mm	58 mm
<b>Pushrod length</b>	60 mm	60 mm	60 mm	60 mm	60 mm	60 mm	60 mm
<b>Installation height GKS, bottom</b>	10,5 mm	10,5 mm	10,5 mm	10,5 mm	10,5 mm	10,5 mm	10,5 mm
<b>Installation height GKS, top</b>	16,0 mm	16,0 mm	16,0 mm	16,0 mm	16,0 mm	16,0 mm	16,0 mm
<b>Installation height GKS dual- stage, bottom</b>	10,5   16,0 mm	10,5   16,0 mm	10,5   16,0 mm	-	10,5   16,0 mm	10,5   16,0 mm	10,5   16,0 mm
<b>GKS theoretical working stroke, bottom</b>	3 mm	3 mm	3 mm	3 mm	3 mm	3 mm	3 mm
<b>GKS theoretical working stroke, top</b>	3,5 mm	3,5 mm	3,5 mm	3,5 mm	3,5 mm	3,5 mm	3,5 mm
<b>Operating tem- perature range</b>	+ 10 °C to + 60 °C	+ 10 °C to + 60 °C	+ 10 °C to + 60 °C	+ 10 °C to + 60 °C	+ 10 °C to + 60 °C	+ 10 °C to + 60 °C	+ 10 °C to + 60 °C
<b>Spec. features/ test system manufacturer</b>	-	-	-	Outstanding shielding in the frequency range up to 6 GHz	-	-	-

MA 2014/ D/H	MA 2012/D/H/ GR 2270/71	MA 2012/D/H/ Pylon	MA 2012/D/H/ VPC-G12-12	MA 2012/D/H/ VPC-G12x-18	MA 2013/D/H/ Pylon	MA 2013/D/H/ VPC-G12-12	MA 2013/D/H/ VPC-G12x-18
100690	53350	51865	59830	53388	53230	57325	53390
Incl. ATS MA14 (Part. 45985-KIT)	Incl. ATS MA12 (Part. 45904-KIT)	Incl. ATS MA12 (Part. 45904-KIT)	Incl. ATS MA12 (Part. 45904-KIT)	Incl. ATS MA12 (Part. 45904-KIT)	Incl. ATS MA13 (Part. 45980-KIT)	Incl. ATS MA13 (Part. 45980-KIT)	Incl. ATS MA13 (Part. 45980-KIT)
Without test system interface	Incl. test system interface GR2270/71	Incl. test system interface Pylon	Incl. test system interface VPC-G12-12	Incl. test system interface VPC-G12x-18	Incl. test system interface Pylon	Incl. test system interface VPC-G12-12	Incl. test system interface VPC-G12x-18
2.000 N	2.000 N	2.000 N	2.000 N	2.000 N	2.000 N	2.000 N	2.000 N
15 mm	15 mm	15 mm	15 mm	15 mm	15 mm	15 mm	15 mm
745 x 584 x 20	501 x 548 x 262	501 x 548 x 262	493 x 565 x 262	493 x 548 x 262	654 x 618 x 262	654 x 618 x 262	649 x 618 x 262
745 x 532 x 650	501 x 494 x 576	501 x 494 x 576	493 x 510 x 576	493 x 494 x 576	654 x 564 x 649	654 x 564 x 649	649 x 564 x 649
540 x 310	285 x 240	285 x 240	285 x 240	285 x 240	440 x 310	440 x 310	440 x 310
75 °	75 °	75 °	75 °	75 °	75 °	75 °	75 °
120 N	120 N	120 N	120 N	120 N	120 N	120 N	120 N
58 mm	58 mm	58 mm	58 mm	58 mm	58 mm	58 mm	58 mm
60 mm	60 mm	60 mm	60 mm	60 mm	60 mm	60 mm	60 mm
10,5 mm	10,5 mm	10,5 mm	10,5 mm	10,5 mm	10,5 mm	10,5 mm	10,5 mm
16,0 mm	16,0 mm	16,0 mm	16,0 mm	16,0 mm	16,0 mm	16,0 mm	16,0 mm
10,5   16,0 mm	10,5   16,0 mm	10,5   16,0 mm	10,5   16,0 mm	10,5   16,0 mm	10,5   16,0 mm	10,5   16,0 mm	10,5   16,0 mm
3 mm	3 mm	3 mm	3 mm	3 mm	3 mm	3 mm	3 mm
3,5 mm	3,5 mm	3,5 mm	3,5 mm	3,5 mm	3,5 mm	3,5 mm	3,5 mm
+ 10 °C bis + 60 °C	+ 10 °C bis + 60 °C	+ 10 °C bis + 60 °C	+ 10 °C bis + 60 °C	+ 10 °C bis + 60 °C	+ 10 °C bis + 60 °C	+ 10 °C bis + 60 °C	+ 10 °C bis + 60 °C
-	- TERADYNE	- Dr. ESCHKE - ROHDE & SCHWARZ	- VIRGINIA PANEL	- VIRGINIA PANEL	- Dr. ESCHKE - ROHDE & SCHWARZ	- VIRGINIA PANEL	- VIRGINIA PANEL

# MA xxxx / ATS MAxx

## Setting up for new test tasks - Exchange made easy



1.) Lift the handle upwards and open the pressure frame unit completely.

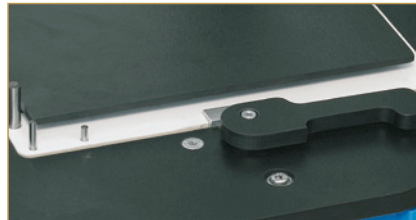

2.) Unlock the probe plate using the tension lever and remove it from the mounting slot.

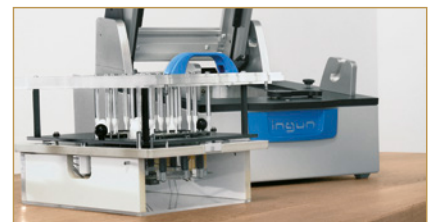

3.) Push the safety slide to the left, press the locking strip and remove the pressure frame plate from above.



4.) Push the safety slide to the left, press the locking strip and insert the pressure frame plate from above.



5.) Insert the probe plate unit into the mounting slot, lock it using the tension lever and close the pressure frame unit.

Informative videos about our products can be found on our website [www.ingun.com](http://www.ingun.com) or on YouTube [www.youtube.com/user/ingunPruefmittelbau](http://www.youtube.com/user/ingunPruefmittelbau)

# MA 21xx

## Manual interchangeable test fixture for series testing

Size
 <p>MA 2109</p>
 <p>MA 2111</p>
 <p>MA 2112</p>
 <p>MA 2113</p>
 <p>MA 2113T</p>
 <p>MA 2114</p>

### Usage

Test fixtures of the MA 21xx series are suitable for contacting electronic units such as printed circuit boards (PCBs) with medium quantities (series testing) and a large number of versions. The test fixtures are designed as interchangeable kit system, are connected to an existing test system and are operated with exchangeable kits that are specially designed for the electronic unit to be tested.

### Features

- Interchangeable kit system
- High contact force of up to 2,000 N
- Available with and without test system interface
- Energy-saving, shock-absorbing opening mechanism
- Modularly configurable internal interface
- Exchangeable kits, can be installed quickly without tools
- Exchangeable kits, can be used without readjustment
- Pressure frame unit and probe plate can be screwed with stacking screws, to form a unit with protected probe field (for storage/transport)

### Life span

- 500,000 load cycles (laboratory conditions)  
The life span is determined in the laboratory using fully automatic, computer-controlled endurance test stations under full load. Since the life span depends on many different factors and in particular on the individual test application, INGUN does not guarantee the actual duration of use in the test field.

### Internal interface

The unloaded internal interface is to be equipped with interface blocks. Interface blocks can be found from page 155 onwards.

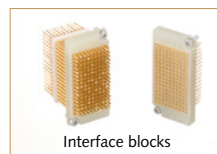

### Functional units

Stiffener bars and numerous other functional units for extension of functionality as required can be found from page 64 onwards.



### Customisation

INGUN provides customising documents for customisation. The exchangeable kits are to be customised according to the customising guidelines info 1317.



Starter kits for customising on site and other customising accessories, such as pushrods, PCB support pins, tooling pins, pre-centring units, marking units, and test plugs, can be found from page 153 onwards.

### MA 21xx - Test fixture

MA 2109	36
MA 2111	37
MA 2112	38
MA 2113	40
MA 2113T	42
MA 2114	44

### ATS MAxx - Exchangeable kits

ATS MA09/S-5	36
ATS MA09	36
ATS MA09/S-5/ESD	36
ATS MA09/ESD	36
ATS MA11/S-5	37, 42
ATS MA11	37, 42
ATS MA11/S-5/ESD	37, 42
ATS MA11/ESD	37, 42
ATS MA11/S-5/HF	37, 42
ATS MA11/HF	37, 42
ATS MA12/S-7	38
ATS MA12	38
ATS MA12/S-7/ESD	38
ATS MA12/ESD	38
ATS MA12/S-7/HF	38
ATS MA12/HF	38
ATS MA2112/S-7/SN	38
ATS MA13/S-10	40
ATS MA13	40
ATS MA13/S-10/ESD	40
ATS MA13/ESD	40
ATS MA13/S-10/HF	40
ATS MA13/HF	40
ATS MA14/S-10	44
ATS MA14	44
ATS MA14/S-10/ESD	44
ATS MA14/ESD	44

### Note

See pages 46 to 48 for overview and comparison table.



# MA 2109

Manual interchangeable test fixture for series testing without test system interface

Series: MA xxxx

Contact force: 2,000 N

Parallel stroke: 15 mm

Maximum usable area: 150 x 170 mm

Load cycles: 500,000 (laboratory conditions)



Basic unit  
with **standard housing**

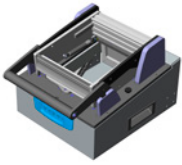

MA 2109/D/H/S-5

Exchangeable kits **with**  
internal SB interface

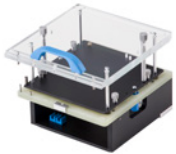

ATS MA09/S-5

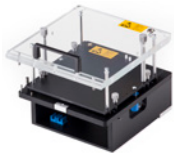

ATS MA09/S-5/ESD

Exchangeable kits **without**  
internal interface

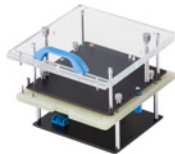

ATS MA09

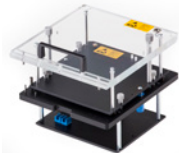

ATS MA09/ESD

## Features

- Fully closed pressure frame unit
- Exchangeable kits with or without internal interface
- Single-sided, double-sided, dual-stage contacting

## Technical specifications

### Basic unit

- Outer dimensions, closed (W x D x H):
  - MA 2109/D/H/S-5: approx. 320 x 445 x 270 mm
- Outer dimensions, open (W x D x H):
  - MA 2109/D/H/S-5: approx. 320 x 445 x 525 mm
- Pressure frame unit opening angle: approx. 75 °
- Pressure frame unit clamping force: approx. 120 N (at full load)

### Exchangeable kit

- Usable area ATS (W x D):
  - ATS MA09/S-5: approx. 150 x 170 mm
  - ATS MA09: approx. 150 x 170 mm
  - ATS MA09/S-5/ESD: approx. 150 x 170 mm
  - ATS MA09/ESD: approx. 150 x 170 mm
- Free height above PCB: approx. 58 mm
- Pushrod length: 60 mm
- GKS installation height, bottom: 10.5 mm
- GKS installation height, top: 16.0 mm
- GKS installation height 2-stage, bottom: 10.5 | 16.0 mm
- GKS theoretical working stroke: 3 mm (bottom), 3.5 mm (top)

### General

- Number of interface blocks: max. 5
- Operating temperature range: + 10 °C to + 60 °C

### Internal interface

- ATS MA09/S-5(/ESD): max. 5 interface blocks SB-P (DUT side) for max. 850 signals, (not included) e.g.

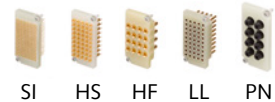
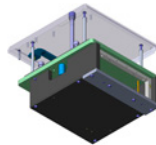

### Note:

Basic units are fitted with SB-T (test system side) interface blocks. More interface blocks can be found from page 155 onwards.

## Ordering information

Basic unit		
Part no.:	34340	MA 2109/D/H/S-5
		Manual interchangeable kit test fixture
Exchangeable kits		
Part no.:	45990-KIT	ATS MA09/S-5
		Standard exchangeable kit with internal interface
Part no.:	45994-KIT	ATS MA09
		Standard exchangeable kit without internal interface
Part no.:	46233-KIT	ATS MA09/S-5/ESD
		ESD exchangeable kit with internal interface
Part no.:	46245-KIT	ATS MA09/ESD
		ESD exchangeable kit without internal interface

Parts with the ending "-KIT" are delivered unassembled. This enables immediate DUT-specific processing.

Basic unit  
with standard housing

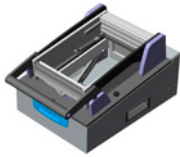

MA 2111/D/H/S-5

Basic unit  
with tall housing

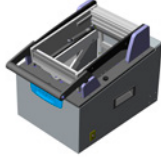

MA 2111/D/H/S-5/HG

Exchangeable kits **with**  
internal SB interface

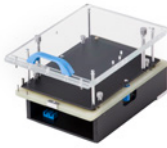

ATS MA11/S-5

Exchangeable kits **without**  
internal interface

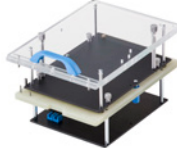

ATS MA11



ATS MA11/S-5/ESD



ATS MA11/ESD

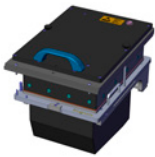

ATS MA11/S-5/HF (\*)

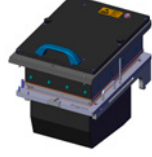

ATS MA11/HF (\*)

**Features**

- Fully closed pressure frame
- Exchangeable kits with or without internal interface
- Single-sided, double-sided, dual-stage contacting

**Technical specifications**

**Basic unit**

- Outer dimensions, closed (W x D x H):
  - MA 2111/D/H/S-5: approx. 320 x 515 x 270 mm
  - MA 2111/D/H/S-5/HG: approx. 320 x 515 x 370 mm
- Outer dimensions, open (W x D x H):
  - MA 2111/D/H/S-5: approx. 320 x 463 x 583 mm
  - MA 2111/D/H/S-5/HG: approx. 320 x 463 x 683 mm
- Pressure frame unit opening angle: approx. 75 °
- Pressure frame unit clamping force: approx. 120 N (at full load)

**Exchangeable kit**

- Usable area ATS (W x D):
  - ATS MA11/S-5: approx. 150 x 240 mm
  - ATS MA11: approx. 150 x 240 mm
  - ATS MA11/S-5/ESD: approx. 150 x 240 mm
  - ATS MA11/ESD: approx. 150 x 240 mm
  - ATS MA11/S-5/HF: approx. 100 x 160 mm
  - ATS MA11/HF: approx. 100 x 160 mm
- Free height above PCB: approx. 58 mm
- Pushrod length: 60 mm
- GKS installation height, bottom: 10.5 mm
- GKS installation height, top: 16.0 mm
- GKS installation height 2-stage, bottom: 10.5 | 16.0 mm
- GKS theoretical working stroke: 3 mm (bottom), 3.5 mm (top)

**General**

- Number of interface blocks: max. 5
- Operating temperature range: + 10 °C to + 60 °C

**Internal interface**

- ATS MA11/S-5(ESD),  
ATS MA11/S-5/HF: max. 5 interface blocks  
SB-P (DUT side) for  
max. 850 signals,  
(not included) e.g.

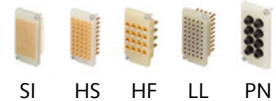
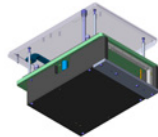

**Note:**

Basic units are fitted with SB-T (test system side) interface blocks.  
 More interface blocks can be found from page 155 onwards.

**Ordering information**

Basic units			
Part no.:	31730	MA 2111/D/H/S-5	Manual interchangeable kit test fixture
Part no.:	33420	MA 2111/D/H/S-5/HG	Manual interchangeable test fixture with tall housing
Exchangeable kits			
Part no.:	45898-KIT	ATS MA11/S-5	Standard exchangeable kit with internal interface
Part no.:	45900-KIT	ATS MA11	Standard exchangeable kit without internal interface
Part no.:	46026-KIT	ATS MA11/S-5/ESD	ESD exchangeable kit with internal interface
Part no.:	46248-KIT	ATS MA11/ESD	ESD exchangeable kit without internal interface
Part no.:	54111	ATS MA11/S-5/HF (*)	RF exchangeable kit with internal interface
Part no.:	54011	ATS MA11/HF (*)	RF exchangeable kit without internal interface

Parts with the ending "-KIT" are delivered unassembled. This enables immediate DUT-specific processing.

\* RF exchangeable kits: Further information about the RF exchangeable kits can be found from page 58 onwards.

# MA 2112

Manual interchangeable test fixture for series testing without test system interface

Series: MA xxxx  
 Contact force: 2,000 N  
 Parallel stroke: 15 mm  
 Maximum usable area: 285 x 240 mm  
 Load cycles: 500,000 (laboratory conditions)



Basic unit with standard housing

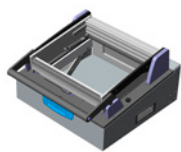

MA 2112/D/H/S-7

Basic unit with tall housing

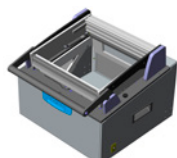

MA 2112/D/H/S-7/HG

Exchangeable kits with internal SB interface

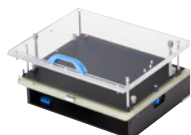

ATS MA12/S-7

Exchangeable kits without internal interface

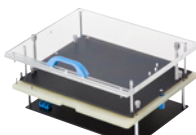

ATS MA12

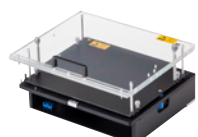

ATS MA12/S-7/ESD

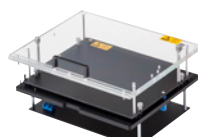

ATS MA12/ESD



ATS MA12/S-7/HF (\*)



ATS MA12/HF (\*)

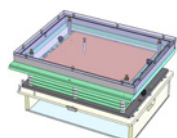

ATS MA2112/S-7/SN

**Rigid pin customisation:**  
 - Contact area:  $\varnothing = 0.30$  mm  
 - Minimum grid: 0.50 mm (without PCB tolerances, when customised by INGUN) (see page 20)

## Features

- Fully closed pressure frame
- Exchangeable kits with or without internal interface
- Single-sided, double-sided, 2-stage or rigid pin contacting

## Technical specifications

### Basic unit

- Outer dimensions, closed (W x D x H):
  - MA 2112/D/H/S-7: approx. 492 x 515 x 270 mm
  - MA 2112/D/H/S-7/HG: approx. 492 x 515 x 370 mm
- Outer dimensions, open (W x D x H):
  - MA 2112/D/H/S-7: approx. 492 x 464 x 591 mm
  - MA 2112/D/H/S-7/HG: approx. 492 x 464 x 691 mm
- Pressure frame unit opening angle: approx. 75 °
- Pressure frame unit clamping force: approx. 120 N (at full load)

### Exchangeable kit

- Usable area ATS (W x D):
  - ATS MA12/S-7: approx. 285 x 240 mm
  - ATS MA12: approx. 285 x 240 mm
  - ATS MA12/S-7/ESD: approx. 285 x 240 mm
  - ATS MA12/ESD: approx. 285 x 240 mm
  - ATS MA12/S-7/HF: approx. 215 x 180 mm
  - ATS MA12/HF: approx. 215 x 180 mm
  - ATS MA2112/S-7/SN: approx. 225 x 220 mm
- Free overall height above PCB: approx. 58 mm | approx. 34 mm (ATS/SN)
- Pushrod length: 60 mm | 36.4 mm (ATS/SN)
- GKS installation height, bottom: 10.5 mm
- GKS installation height, top: 16.0 mm
- GKS installation height 2-stage, bottom: 10.5 | 16.0 mm
- GKS theoretical working stroke: 3 mm (bottom), 3.5 mm (top)

### General

- Number of interface blocks: max. 7
- Operating temperature range: + 10 °C to + 60 °C

### Internal interface

- ATS MA12/S-7(/ESD), ATS MA12/S-7/HF, ATS MA2112/S-7/SN: max. 7 interface blocks SB-P (DUT side) for max. 1,190 signals (not included), e.g.

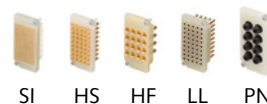
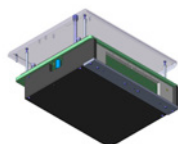

### Note:











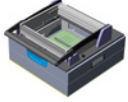

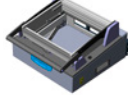
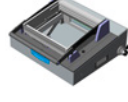
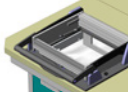
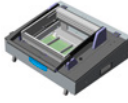

Basic units are fitted with SB-T (test system side) interface blocks. More interface blocks can be found from page 155 onwards.

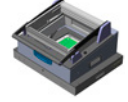
## Ordering information

Basic units			
Part no.:	32660	MA 2112/D/H/S-7	Manual interchangeable kit test fixture
Part no.:	33460	MA 2112/D/H/S-7/HG	Manual interchangeable test fixture with tall housing
Exchangeable kits			
Part no.:	45903-KIT	ATS MA12/S-7	Standard exchangeable kit with internal interface
Part no.:	45904-KIT	ATS MA12	Standard exchangeable kit without internal interface
Part no.:	46236-KIT	ATS MA12/S-7/ESD	ESD exchangeable kit with internal interface
Part no.:	46250-KIT	ATS MA12/ESD	ESD exchangeable kit without internal interface
Part no.:	54112	ATS MA12/S-7/HF (*)	RF exchangeable kit with internal interface
Part no.:	54012	ATS MA12/HF (*)	RF exchangeable kit without internal interface
Part no.:	33335	ATS MA2112/S-7/SN	Rigid pin exchangeable kit with internal interface

Parts with the ending "-KIT" are delivered unassembled. This enables immediate DUT-specific processing.

\* RF exchangeable kits: Further information about the RF exchangeable kits can be found from page 58 onwards.

Test system interface	Part number   Description   Outer dimensions (W x D x H)		
	Basic units with <b>standard housing</b>		Basic units with <b>tall housing</b>
<b>COBHAM (AEROFLEX) 4200/4250</b>		<b>33750</b> MA 2112/F/H/S-7/AF 4200/4250 approx. 514 x 552 x 279 mm (closed) approx. 514 x 522 x 602 mm (open)	
<b>DIGITALTEST MTS 100</b>		<b>33045</b> MA 2112/D/H/S-7/DT MTS100 approx. 538 x 583 x 262 mm (closed) approx. 538 x 529 x 583 mm (open)	
<b>DIGITAL TEST MTS 300</b>		<b>32958</b> MA 2112/D/H/S-7/DT MTS300 approx. 605 x 578 x 273 mm (closed) approx. 605 x 527 x 594 mm (open)	
<b>KONRAD KT-ITA-21</b>			 <b>33480</b> MA 2112/D/H/S-7/HG/KR KT-ITA-21 approx. 492 x 542 x 370 mm (closed) approx. 492 x 489 x 691 mm (open)
<b>MAC-PANEL Titanium Hz</b>		<b>40978</b> MA 2112/D/H/S-7/MP Titanium Hz approx. 497 x 553 x 262 mm (closed) approx. 497 x 500 x 583 mm (open)	
<b>REINHARDT VG 12 (KMFT 670)</b>		<b>32735</b> MA 2112/D/H/S-7/RH VG12 approx. 700 x 576 x 259 mm (closed) approx. 700 x 523 x 580 mm (open)	
<b>SPEA 3030</b>		<b>37970</b> MA 2112/S-7/SPEA 3030 (table installat.) approx. 460 x 542 x 110 mm (closed) approx. 460 x 495 x 433 mm (open)	
<b>TERADYNE TD 88xx-S</b>		<b>32965</b> MA 2112/F/H/S-7/TD 88xx-S approx. 648 x 584 x 287 mm (closed) approx. 648 x 533 x 608 mm (open)	
<b>TEADYNE TD 88xx-M</b>		<b>33464</b> MA 2112/F/H/S-7/TD 88xx-M approx. 648 x 584 x 287 mm (closed) approx. 648 x 533 x 608 mm (open)	
<b>TERADYNE TESTSTATION GR 228x 15/07</b>		<b>44880</b> MA 2112/D/H/S-7/GR 228x 15/07 approx. 554 x 523 x 362 mm (closed) approx. 554 x 464 x 683 mm (open)	
<b>TERADYNE TESTSTATION GR 228x 15/15</b>		<b>37745</b> MA 2112/D/H/S-7/GR 228x 15/15 approx. 554 x 523 x 362 mm (closed) approx. 554 x 470 x 683 mm (open)	
<b>TERADYNE TESTSTATION GR 2270/71</b>		<b>33462</b> MA 2112/D/H/S-7/GR 2270/71 approx. 501 x 548 x 262 mm (closed) approx. 501 x 495 x 583 mm (open)	 <b>33457</b> MA 2112/D/H/S-7/HG/GR 2270/71 approx. 501 x 548 x 362 mm (closed) approx. 501 x 495 x 683 mm (open)
<b>Dr. ESCHKE, ROHDE &amp; SCHWARZ Pylon</b>		<b>33681</b> MA 2112/D/H/S-7/Pylon approx. 501 x 548 x 262 mm (closed) approx. 501 x 495 x 583 mm (open)	 <b>33678</b> MA 2112/D/H/S-7/HG/Pylon approx. 501 x 548 x 362 mm (closed) approx. 501 x 495 x 683 mm (open)
<b>VIRGINIA PANEL VPC-S6</b>		<b>33040</b> MA 2112/D/H/S-7/VPC-S6 approx. 491 x 565 x 262 mm (closed) approx. 491 x 514 x 583 mm (open)	
<b>VIRGINIA PANEL VPC-G12-12</b>		<b>35503</b> MA 2112/D/H/S-7/VPC-G12-12 approx. 494 x 565 x 262 mm (closed) approx. 494 x 514 x 583 mm (open)	 <b>46730</b> MA 2112/D/H/S-7/HG/VPC-G12-12 approx. 494 x 565 x 362 mm (closed) approx. 494 x 514 x 683 mm (open)
<b>VIRGINIA PANEL VPC-G12x-18</b>			 <b>58840</b> MA 2112/D/H/S-7/HG/VPC-G12x-18 approx. 491 x 548 x 362 mm (closed) approx. 491 x 495 x 683 mm (open)



# MA 2113

Manual interchangeable test fixture for series testing without test system interface

Series: MA xxxx

Contact force: 2,000 N

Parallel stroke: 15 mm

Maximum usable area: 440 x 310 mm

Load cycles: 500,000 (laboratory conditions)



Basic unit with standard housing

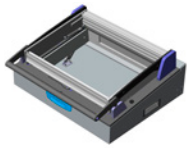

MA 2113/D/H/S-10

Basic unit with tall housing

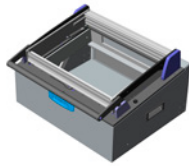

MA 2113/D/H/S-10/HG

Exchangeable kits with internal SB interface

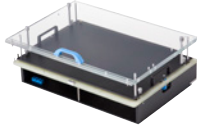

ATS MA13/S-10

Exchangeable kits without internal interface

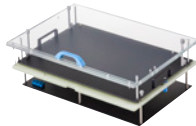

ATS MA13



ATS MA13/S-10/ESD



ATS MA13/ESD



ATS MA13/S-10/HF (\*)



ATS MA13/HF (\*)

## Features

- Fully closed pressure frame
- Exchangeable kits with or without internal interface
- Single-sided, double-sided, dual-stage contacting

## Technical specifications

### Basic unit

- Outer dimensions, closed (W x D x H):
  - MA 2113/D/H/S-10: approx. 648 x 584 x 270 mm
  - MA 2113/D/H/S-10/HG: approx. 648 x 584 x 370 mm
- Outer dimensions, open (W x D x H):
  - MA 2113/D/H/S-10: approx. 648 x 533 x 657 mm
  - MA 2113/D/H/S-10/HG: approx. 648 x 533 x 757 mm
- Pressure frame unit opening angle: approx. 75 °
- Pressure frame unit clamping force: approx. 120 N (at full load)

### Exchangeable kit

- Usable area ATS (W x D):
  - ATS MA13/S-10: approx. 440 x 310 mm
  - ATS MA13: approx. 440 x 310 mm
  - ATS MA13/S-10/ESD: approx. 440 x 310 mm
  - ATS MA13/ESD: approx. 440 x 310 mm
  - ATS MA13/S-10/HF: approx. 375 x 240 mm
  - ATS MA13/HF: approx. 375 x 240 mm
- Free height above PCB: approx. 58 mm
- Pushrod length: 60 mm
- GKS installation height, bottom: 10.5 mm
- GKS installation height, top: 16.0 mm
- GKS installation height 2-stage, bottom: 10.5 | 16.0 mm
- GKS theoretical working stroke: 3 mm (bottom), 3.5 mm (top)

### General

- Number of interface blocks: max. 10
- Operating temperature range: + 10 °C to + 60 °C

### Internal interface

- ATS MA13/S-10(/ESD), ATS MA13/S-10/HF: max. 10 interface blocks SB-P (DUT side) for max. 1,700 signals (not included), e.g.

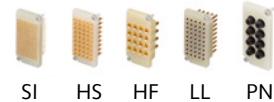
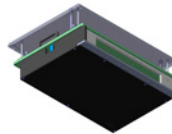

## Note:

Basic units are fitted with SB-T (test system side) interface blocks. More interface blocks can be found from page 155 onwards.











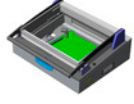
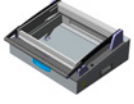

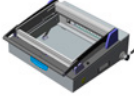

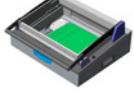

## Ordering information

Basic units			
Part no.:	32500	MA 2113/D/H/S-10	Manual interchangeable kit test fixture
Part no.:	32700	MA 2113/D/H/S-10/HG	Manual interchangeable test fixture with tall housing
Exchangeable kits			
Part no.:	45908-KIT	ATS MA13/S-10	Standard exchangeable kit with internal interface
Part no.:	45980-KIT	ATS MA13	Standard exchangeable kit without internal interface
Part no.:	46239-KIT	ATS MA13/S-10/ESD	ESD exchangeable kit with internal interface
Part no.:	46254-KIT	ATS MA13/ESD	ESD exchangeable kit without internal interface
Part no.:	54113	ATS MA13/S-10/HF (*)	RF exchangeable kit with internal interface
Part no.:	54013	ATS MA13/HF (*)	RF exchangeable kit without internal interface

Parts with the ending "-KIT" are delivered unassembled. This enables immediate DUT-specific processing.

\* RF exchangeable kits: Further information about the RF exchangeable kits can be found from page 58 onwards.



Test system interface	Part number   Description   Outer dimensions (W x D x H)			
	Basic units with <b>standard housing</b>			
<b>COBHAM (AEROFLEX) 4200/4250</b>		<b>37736</b> MA 2113/F/H/S-10/AF 4200/4250 approx. 648 x 595 x 302 mm (closed) approx. 648 x 548 x 696 mm (open)		
<b>DIGITAL TEST MTS 300</b>		<b>33443</b> MA 2113/D/H/S-10/DT MTS300 approx. 651 x 585 x 283 mm (closed) approx. 651 x 533 x 670 mm (open)		
<b>KEYSIGHT i1000</b>		<b>42600</b> MA 2113/D/H/S-10/KS i1000 approx. 648 x 585 x 270 mm (closed) approx. 648 x 533 x 657 mm (open)		
<b>MAC-PANEL Titanium Hz</b>			<b>47540</b> MA 2113/D/H/S-10/HG/MP Titanium Hz approx. 659 x 624 x 362 mm (closed) approx. 659 x 570 x 750 mm (open)	
<b>REINHARDT VG 12 (KMFT 670)</b>		<b>38871</b> MA 2113/D/H/S-10/RH VG12 approx. 766 x 651 x 278 mm (closed) approx. 766 x 598 x 665 mm (open)		
<b>SPEA 3030</b>		<b>32701</b> MA 2113/S-10/SPEA 3030 (table installat.) approx. 616 x 612 x 110 mm (closed) approx. 616 x 565 x 501 mm (open)		
<b>TERADYNE TD 88xx-S</b>		<b>33290</b> MA 2113/D/H/S-10/TD 88xx-S approx. 648 x 586 x 295 mm (closed) approx. 648 x 533 x 682 mm (open)		
<b>TERADYNE TD 88xx-M</b>		<b>33444</b> MA 2113/D/H/S-10/TD 88xx-M approx. 648 x 586 x 295 mm (closed) approx. 648 x 533 x 682 mm (open)		
<b>TERADYNE TESTSTATION GR 228x 15/07</b>		<b>33764</b> MA 2113/D/H/S-10/GR 228x 15/07 approx. 648 x 586 x 362 mm (closed) approx. 648 x 533 x 749 mm (open)		
<b>TERADYNE TESTSTATION GR 2270/71</b>		<b>32920</b> MA 2113/D/H/S-10/GR 2270/71 approx. 654 x 618 x 262 mm (closed) approx. 654 x 564 x 649 mm (open)		<b>33448</b> MA 2113/D/H/S-10/HG/GR 2270/71 approx. 654 x 618 x 362 mm (closed) approx. 654 x 564 x 749 mm (open)
<b>Dr. ESCHKE, ROHDE &amp; SCHWARZ Pylon</b>		<b>33688</b> MA 2113/D/H/S-10/Pylon approx. 654 x 618 x 262 mm (closed) approx. 654 x 564 x 649 mm (open)		<b>33679</b> MA 2113/D/H/S-10/HG/Pylon approx. 654 x 618 x 362 mm (closed) approx. 654 x 564 x 749 mm (open)
<b>VIRGINIA PANEL VPC-G12-12</b>		<b>35904</b> MA 2113/D/H/S-10/VPC-G12-12 approx. 650 x 631 x 262 mm (closed) approx. 650 x 577 x 649 mm (open)		<b>46040</b> MA 2113/D/H/S-10/HG/VPC-G12-12 approx. 650 x 631 x 362 mm (closed) approx. 650 x 577 x 749 mm (open)
<b>VIRGINIA PANEL VPC-G12x-18</b>		<b>37799</b> MA 2113/D/H/S-10/VPC-G12x-18 approx. 648 x 618 x 270 mm (closed) approx. 648 x 564 x 657 mm (open)		
<b>VIRGINIA PANEL VPC-G18x</b>				<b>51346</b> MA 2113/D/H/S-10/HG/VPC-G18x approx. 658 x 635 x 362 mm (closed) approx. 658 x 581 x 749 mm (open)
<b>VIRGINIA PANEL VPC-G20x</b>				<b>49480</b> MA 2113/D/H/S-10/HG/VPC-G20x approx. 658 x 675 x 362 mm (closed) approx. 658 x 621 x 749 mm (open)

Compatible exchangeable kits with ATS MA13 size can be found on page 40.

# MA 2113T

Manual Tandem interchangeable test fixture for the series testing without test system interface

Series: MA xxxx

Contact force: 2,000 N

Parallel stroke: 15 mm

Maximum usable area: 2x 150 x 240 mm

Load cycles: 500,000 (laboratory conditions)

ingun®

Basic unit  
with **standard housing**

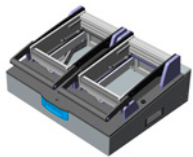

MA 2113T/D/H/2x S-5

Basic unit  
with **tall housing**

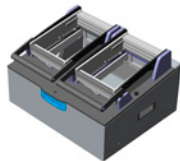

MA 2113T/D/H/2x S-5/HG

Exchangeable kits **with**  
internal SB interface

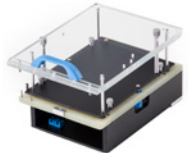

ATS MA11/S-5

Exchangeable kits **without**  
internal interface

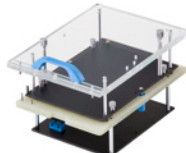

ATS MA11

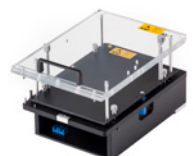

ATS MA11/S-5/ESD

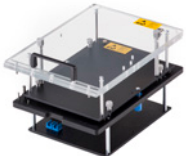

ATS MA11/ESD

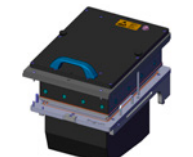

ATS MA11/S-5/HF (\*)

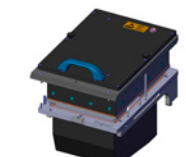

ATS MA11/HF (\*)

## Features

- Two drive units on one housing, thereby reducing overall test time
- Fully closed pressure frame
- Exchangeable kits with or without internal interface
- Single-sided, double-sided, dual-stage contacting

## Technical specifications

### Basic unit

- Outer dimensions, closed (W x D x H):
  - MA 2113T/D/H/2x S-5: approx. 648 x 533 x 270 mm
  - MA 2113T/D/H/2x S-5/HG: approx. 648 x 533 x 370 mm
- Outer dimensions, open (W x D x H):
  - MA 2113T/D/H/2x S-5: approx. 648 x 533 x 591 mm
  - MA 2113T/D/H/2x S-5/HG: approx. 648 x 533 x 691 mm
- Pressure frame unit opening angle: approx. 75 °
- Pressure frame unit clamping force: approx. 120 N (at full load)

### Exchangeable kit

- Usable area ATS (W x D):
  - ATS MA11/S-5: approx. 150 x 240 mm
  - ATS MA11: approx. 150 x 240 mm
  - ATS MA11/S-5/ESD: approx. 150 x 240 mm
  - ATS MA11/ESD: approx. 150 x 240 mm
  - ATS MA11/S-5/HF: approx. 100 x 160 mm
  - ATS MA11/HF: approx. 100 x 160 mm
- Free height above PCB: approx. 58 mm
- Pushrod length: 60 mm
- GKS installation height, bottom: 10.5 mm
- GKS installation height, top: 16.0 mm
- GKS installation height 2-stage, bottom: 10.5 | 16.0 mm
- GKS theoretical working stroke: 3 mm (bottom), 3.5 mm (top)

### General

- Number of interface blocks: max. 2 x 5 (basic unit)
- Operating temperature range: + 10 °C to + 60 °C

### Internal interface

- ATS MA11/S-5(/ESD),  
ATS MA11/S-5/HF: max. 5 interface blocks  
SB-P (DUT side) for  
max. 850 signals  
(not included), e.g.

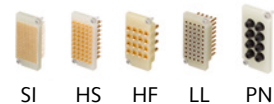
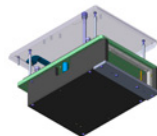

## Note:

Basic units are fitted with SB-T (test system side) interface blocks.  
More interface blocks can be found from page 155 onwards.

## Ordering information

Basic units			
Part no.:	32300	MA 2113T/D/H/2x S-5	Manual tandem interchangeable kit test fixture
Part no.:	36666	MA 2113T/D/H/2x S-5/HG	Manual tandem interchangeable test fixture with tall housing
Exchangeable kits			
Part no.:	45898-KIT	ATS MA11/S-5	Standard exchangeable kit with internal interface
Part no.:	45900-KIT	ATS MA11	Standard exchangeable kit without internal interface
Part no.:	46026-KIT	ATS MA11/S-5/ESD	ESD exchangeable kit with internal interface
Part no.:	46248-KIT	ATS MA11/ESD	ESD exchangeable kit without internal interface
Part no.:	54111	ATS MA11/S-5/HF (*)	RF exchangeable kit with internal interface
Part no.:	54011	ATS MA11/HF (*)	RF exchangeable kit without internal interface

For tandem operation, two exchangeable kits of size ATS MA11 are required.

Parts with the ending "-KIT" are delivered unassembled. This enables immediate DUT-specific processing.

\* RF exchangeable kits: Further information about the RF exchangeable kits can be found from page 58 onwards.

Test system interface	Part number   Description   Outer dimensions (W x D x H)	
	Basic units with <b>standard housing</b>	
DIGITAL TEST MTS 300	 <b>33380</b> MA 2113T/D/H/2x S-5/DT MTS300 approx. 651 x 533 x 283 mm (closed) approx. 651 x 533 x 604 mm (open)	
REINHARDT VG 12 (KMFT 670)	 <b>48850</b> MA 2113T/D/H/2x S-5/RH VG12 approx. 766 x 598 x 278 mm (closed) approx. 766 x 598 x 599 mm (open)	
TERADYNE TD 88xx-S	 <b>33439</b> MA 2113T/D/H/2x S-5/TD 88xx-S approx. 648 x 533 x 295 mm (closed) approx. 648 x 533 x 617 mm (open)	
TERADYNE TD 88xx-M	 <b>33440</b> MA 2113T/D/H/2x S-5/TD 88xx-M approx. 648 x 533 x 295 mm (closed) approx. 648 x 533 x 617 mm (open)	
TERADYNE TESTSTATION GR 228x 15/07	 <b>44630</b> MA 2113T/D/H/2x S-5/GR 228x 15/07 approx. 648 x 533 x 362 mm (closed) approx. 648 x 533 x 683 mm (open)	
TERADYNE TESTSTATION GR 2270/71	 <b>33543</b> MA 2113T/D/H/2x S-5/GR 2270/71 approx. 654 x 564 x 262 mm (closed) approx. 654 x 564 x 583 mm (open)	
Dr. ESCHKE, ROHDE & SCHWARZ Pylon	 <b>33680</b> MA 2113T/D/H/2x S-5/Pylon approx. 654 x 564 x 262 mm (closed) approx. 654 x 564 x 583 mm (open)	
VIRGINIA PANEL VPC-G12-12	 <b>46405</b> MA 2113T/D/H/2x S-5/VPC-G12-12 approx. 648 x 576 x 262 mm (closed) approx. 648 x 576 x 583 mm (open)	 <b>46770</b> MA 2113T/D/H/2x S-5/HG/VPC-G12-12 approx. 648 x 576 x 362 mm (closed) approx. 648 x 576 x 683 mm (open)
VIRGINIA PANEL VPC-G12x-18	 <b>57940</b> MA 2113T/D/H/2x S-5/VPC-G12x-18 approx. 648 x 564 x 262 mm (closed) approx. 648 x 564 x 583 mm (open)	

Compatible interchangeable kits with ATS MA11 size can be found on page 42.

# MA 2114

Manual interchangeable test fixture for the series test without test system interface

Series: MA xxxx

Contact force: 2,000 N

Parallel stroke: 15 mm

Maximum usable area: 540 x 310 mm

Load cycles: 500,000 (laboratory conditions)



Basic unit with standard housing

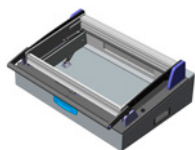

MA 2114/D/H/S-10

Basic unit with tall housing

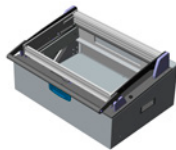

MA 2114/D/H/S-10/HG

Exchangeable kits with internal SB interface

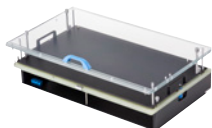

ATS MA14/S-10

Exchangeable kits without internal interface

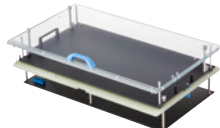

ATS MA14



ATS MA14/S-10/ESD



ATS MA14/ESD

## Features

- Fully closed pressure frame
- Exchangeable kits with or without internal interface
- Single-sided, double-sided, dual-stage contacting

## Technical specifications

### Basic unit

- Outer dimensions, closed (W x D x H):
  - MA 2114/D/H/S-10: approx. 748 x 584 x 270 mm
  - MA 2114/D/H/S-10/HG: approx. 748 x 584 x 370 mm
- Outer dimensions, open (W x D x H):
  - MA 2114/D/H/S-10: approx. 748 x 533 x 653 mm
  - MA 2114/D/H/S-10/HG: approx. 748 x 533 x 753 mm
- Pressure frame unit opening angle: approx. 75 °
- Pressure frame unit clamping force: approx. 120 N (at full load)

### Exchangeable kit

- Usable area ATS (W x D):
  - ATS MA14/S-10: approx. 540 x 310 mm
  - ATS MA14: approx. 540 x 310 mm
  - ATS MA14/S-10/ESD: approx. 540 x 310 mm
  - ATS MA14/ESD: approx. 540 x 310 mm
- Free height above PCB: approx. 58 mm
- Pushrod length: 60 mm
- GKS installation height, bottom: 10.5 mm
- GKS installation height, top: 16.0 mm
- GKS installation height 2-stage, bottom: 10.5 | 16.0 mm
- GKS theoretical working stroke: 3 mm (bottom), 3.5 mm (top)

### General

- Number of interface blocks: max. 10
- Operating temperature range: + 10 °C to + 60 °C

### Internal interface

- ATS MA14/S-10(/ESD): max. 10 interface blocks SB-P (DUT side) for max. 1,700 signals (not included), e.g.

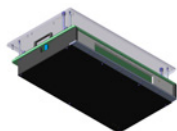



### Note:

Basic units are fitted with SB-T (test system side) interface blocks. More interface blocks can be found from page 155 onwards.

## Ordering information

Basic units			
Part no.:	34350	MA 2114/D/H/S-10	Manual interchangeable kit test fixture
Part no.:	42290	MA 2114/D/H/S-10/HG	Manual interchangeable test fixture with tall housing
Exchangeable kits			
Part no.:	45983-KIT	ATS MA14/S-10	Standard exchangeable kit with internal interface
Part no.:	45985-KIT	ATS MA14	Standard exchangeable kit without internal interface
Part no.:	46242-KIT	ATS MA14/S-10/ESD	ESD exchangeable kit with internal interface
Part no.:	46257-KIT	ATS MA14/ESD	ESD exchangeable kit without internal interface

Parts with the ending "-KIT" are delivered unassembled. This enables immediate DUT-specific processing.

Test system interface	Part number   Description   Outer dimensions (W x D x H)		
	Basic units with <b>standard housing</b>		Basic units with <b>tall housing</b>
<b>Dr. ESCHKE, ROHDE &amp; SCHWARZ Pylon</b>		<b>48980</b> MA 2114/D/H/S-10/Pylon approx. 754 x 663 x 262 mm (closed) approx. 754 x 609 x 645 mm (open)	
<b>VIRGINIA PANEL VPC-G14</b>			 <b>59730</b> MA 2114/D/H/S-10/HG/VPC-G14 approx. 759 x 675 x 370 mm (closed) approx. 759 x 621 x 753 mm (open)

Compatible exchangeable kits with ATS MA14 size can be found on page 44.



Description	Part number	Version	Test system interface	Max. interface blocks	Max. contact force [N]	Parallel stroke [mm]	Outer dimensions - closed - open (W x D x H mm)	Maximum usable area ATS MAxx (W x D mm)
<b>MA 2109/D/H/S-5</b>	34340	Standard	-	5	2,000	15	- 320 x 445 x 270 - 320 x 445 x 525	150 x 170
<b>MA 2111/D/H/S-5</b>	31730	Standard	-	5	2,000	15	- 320 x 515 x 270 - 320 x 463 x 583	150 x 240
<b>MA 2111/D/H/S-5/HG</b>	33420	Tall housing	-	5	2,000	15	- 320 x 515 x 370 - 320 x 463 x 683	150 x 240
<b>MA 2112/D/H/S-7</b>	32660	Standard	-	7	2,000	15	- 492 x 515 x 270 - 492 x 464 x 591	285 x 240
<b>MA 2112/D/H/S-7/HG</b>	33460	Tall housing	-	7	2,000	15	- 492 x 515 x 370 - 492 x 464 x 691	285 x 240
<b>MA 2113/D/H/S-10</b>	32500	Standard	-	10	2,000	15	- 648 x 584 x 270 - 648 x 533 x 657	440 x 310
<b>MA 2113/D/H/S-10/HG</b>	32700	Tall housing	-	10	2,000	15	- 648 x 584 x 370 - 648 x 533 x 757	440 x 310
<b>MA 2113T/D/H/2x S-5</b>	32300	Tandem	-	2x 5	2,000	15	- 648 x 533 x 270 - 648 x 533 x 591	2x 150 x 240
<b>MA 2113T/D/H/2x S-5/HG</b>	36666	- Tandem - Tall housing	-	2x 5	2,000	15	- 648 x 533 x 370 - 648 x 533 x 691	2x 150 x 240
<b>MA 2114/D/H/S-10</b>	34350	Standard	-	10	2,000	15	- 748 x 584 x 270 - 748 x 533 x 653	540 x 310
<b>MA 2114/D/H/S-10/HG</b>	42290	Tall housing	-	10	2,000	15	- 748 x 584 x 370 - 748 x 533 x 753	540 x 310

Description	Part number	Version	Test system interface	Max. Interface blocks	Max. Contact force [N]	Parallel stroke [mm]	Outer dimensions - closed - open (W x D x H mm)	Maximum usable area ATS MAXx (W x D mm)
MA 2112/F/H/S-7/ AF 4200/4250	33750	Standard	COBHAM (AEROFLEX)	7	2,000	15	- 514 x 552 x 279 - 514 x 522 x 602	285 x 240
MA 2113/F/H/S-10/ AF 4200/4250	37736	Standard	COBHAM (AEROFLEX)	10	2,000	15	- 648 x 595 x 302 - 648 x 548 x 696	440 x 310
MA 2112/D/H/S-7/ DT MTS100	33045	Standard	DIGITALTEST	7	2,000	15	- 538 x 583 x 262 - 538 x 529 x 583	285 x 240
MA 2112/D/H/S-7/ DT MTS300	32958	Standard	DIGITALTEST	7	2,000	15	- 605 x 578 x 273 - 605 x 527 x 594	285 x 240
MA 2113/D/H/S-10/ DT MTS300	33443	Standard	DIGITALTEST	10	2,000	15	- 651 x 585 x 283 - 651 x 533 x 670	440 x 310
MA 2113T/D/H/2x S-5/ DT MTS300	33380	Tandem	DIGITALTEST	2x 5	2,000	15	- 651 x 533 x 283 - 651 x 533 x 604	2x 150 x 240
MA 2113/D/H/S-10/ KS i1000	42600	Standard	KEYSIGHT	10	2,000	15	- 648 x 585 x 270 - 648 x 533 x 657	440 x 310
MA 2112/D/H/S-7/HG/ KR KT-ITA-21	33480	Tall housing	KONRAD	7	2,000	15	- 492 x 542 x 370 - 492 x 489 x 691	285 x 240
MA 2112/D/H/S-7/ MP Titanium Hz	40978	Standard	MAC-PANEL	7	2,000	15	- 497 x 553 x 262 - 497 x 500 x 583	285 x 240
MA 2113/D/H/S-10/HG/ MP Titanium Hz	47540	Tall housing	MAC-PANEL	10	2,000	15	- 659 x 624 x 362 - 659 x 570 x 750	440 x 310
MA 2112/D/H/S-7/ RH VG12 (KMFT 670)	32735	Standard	REINHARDT	7	2,000	15	- 700 x 576 x 259 - 700 x 523 x 580	285 x 240
MA 2113/D/H/S-10/ RH VG12 (KMFT 670)	38871	Standard	REINHARDT	10	2,000	15	- 766 x 651 x 278 - 766 x 598 x 665	440 x 310
MA 2113T/D/H/2x S-5/ RH VG12 (KMFT 670)	48850	Tandem	REINHARDT	2x 5	2,000	15	- 766 x 598 x 278 - 766 x 598 x 599	2x 150 x 240
MA 2112/S-7/ SPEA 3030	37970	Standard (table installation)	SPEA	7	2,000	15	- 460 x 542 x 110 - 460 x 495 x 433	285 x 240
MA 2113/S-10/ SPEA 3030	32701	Standard (table installation)	SPEA	10	2,000	15	- 616 x 612 x 110 - 616 x 565 x 501	440 x 310
MA 2112/F/H/S-7/ TD 88xx-S	32965	Standard	TERADYNE	7	2,000	15	- 648 x 584 x 287 - 648 x 533 x 608	285 x 240
MA 2113/D/H/S-10/ TD 88xx-S	33290	Standard	TERADYNE	10	2,000	15	- 648 x 586 x 295 - 648 x 533 x 682	440 x 310
MA 2113T/D/H/2x S-5/ TD 88xx-S	33439	Tandem	TERADYNE	2x 5	2,000	15	- 648 x 533 x 295 - 648 x 533 x 617	2x 150 x 240
MA 2112/F/H/S-7/ TD 88xx-M	33464	Standard	TERADYNE	7	2,000	15	- 648 x 584 x 287 - 648 x 533 x 608	285 x 240
MA 2113/D/H/S-10/ TD 88xx-M	33444	Standard	TERADYNE	10	2,000	15	- 648 x 586 x 295 - 648 x 533 x 682	440 x 310
MA 2113T/D/H/2x S-5/ TD 88xx-M	33440	Tandem	TERADYNE	2x 5	2,000	15	- 648 x 533 x 295 - 648 x 533 x 617	2x 150 x 240
MA 2112/D/H/S-7/ GR 228x 15/07	44880	Standard	TERADYNE	7	2,000	15	- 554 x 523 x 362 - 554 x 464 x 683	285 x 240
MA 2113/D/H/S-10/ GR 228x 15/07	33764	Standard	TERADYNE	10	2,000	15	- 648 x 586 x 362 - 648 x 533 x 749	440 x 310
MA 2113T/D/H/2x S-5/ GR 228x 15/07	44630	Tandem	TERADYNE	2x 5	2,000	15	- 648 x 533 x 362 - 648 x 533 x 683	2x 150 x 240

Description	Part number	Version	Test system interface	Max. interface blocks	Max. contact force [N]	Parallel stroke [mm]	Outer dimensions - closed - open (W x D x H mm)	Maximum usable area ATS MAxx (W x D mm)
MA 2112/D/H/S-7/ GR 228x 15/15	37745	Standard	TERADYNE	7	2,000	15	- 554 x 523 x 362 - 554 x 470 x 683	285 x 240
MA 2112/D/H/S-7/ GR 2270/71	33462	Standard	TERADYNE	7	2,000	15	- 501 x 548 x 262 - 501 x 495 x 583	285 x 240
MA 2112/D/H/S-7/HG/ GR 2270/71	33457	Tall housing	TERADYNE	7	2,000	15	- 501 x 548 x 362 - 501 x 495 x 683	285 x 240
MA 2113/D/H/S-10/ GR 2270/71	32920	Standard	TERADYNE	10	2,000	15	- 654 x 618 x 262 - 654 x 564 x 649	440 x 310
MA 2113/D/H/S-10/HG/ GR 2270/71	33448	Tall housing	TERADYNE	10	2,000	15	- 654 x 618 x 362 - 654 x 564 x 749	440 x 310
MA 2113T/D/H/2x S-5/ GR 2270/71	33543	Tandem	TERADYNE	2x 5	2,000	15	- 654 x 564 x 262 - 654 x 564 x 583	2x 150 x 240
MA 2112/D/H/S-7/ Pylon	33681	Standard	PYLON	7	2,000	15	- 501 x 548 x 262 - 501 x 495 x 583	285 x 240
MA 2112/D/H/S-7/HG/ Pylon	33678	Tall housing	PYLON	7	2,000	15	- 501 x 548 x 362 - 501 x 495 x 683	285 x 240
MA 2113/D/H/S-10/ Pylon	33688	Standard	PYLON	10	2,000	15	- 654 x 618 x 262 - 654 x 564 x 649	440 x 310
MA 2113/D/H/S-10/HG/ Pylon	33679	Tall housing	PYLON	10	2,000	15	- 654 x 618 x 362 - 654 x 564 x 749	440 x 310
MA 2113T/D/H/2x S-5/ Pylon	33680	Tandem	PYLON	2x 5	2,000	15	- 654 x 564 x 262 - 654 x 564 x 583	2x 150 x 240
MA 2114/D/H/S-10/ Pylon	48980	Standard	PYLON	10	2,000	15	- 754 x 663 x 262 - 754 x 609 x 645	540 x 310
MA 2112/D/H/S-7/ VPC-S6	33040	Standard	VIRGINIA PANEL	7	2,000	15	- 491 x 565 x 262 - 491 x 514 x 583	285 x 240
MA 2112/D/H/S-7/ VPC-G12-12	35503	Standard	VIRGINIA PANEL	7	2,000	15	- 494 x 565 x 262 - 494 x 514 x 583	285 x 240
MA 2112/D/H/S-7/HG/ VPC-G12-12	46730	Tall housing	VIRGINIA PANEL	7	2,000	15	- 494 x 565 x 362 - 494 x 514 x 683	285 x 240
MA 2113/D/H/S-10/ VPC-G12-12	35904	Standard	VIRGINIA PANEL	10	2,000	15	- 650 x 631 x 262 - 650 x 577 x 649	440 x 310
MA 2113/D/H/S-10/HG/ VPC-G12-12	46040	Tall housing	VIRGINIA PANEL	10	2,000	15	- 650 x 631 x 362 - 650 x 577 x 749	440 x 310
MA 2113T/D/H/2x S-5/ VPC-G12-12	46405	Tandem	VIRGINIA PANEL	2x 5	2,000	15	- 648 x 576 x 262 - 648 x 576 x 583	2x 150 x 240
MA 2113T/D/H/2x S-5/HG/ VPC-G12-12	46770	- Tandem - Tall Housing	VIRGINIA PANEL	2x 5	2,000	15	- 648 x 576 x 362 - 648 x 576 x 683	2x 150 x 240
MA 2112/D/H/S-7/HG/ VPC-G12x-18	58840	Tall housing	VIRGINIA PANEL	7	2,000	15	- 491 x 548 x 362 - 491 x 495 x 683	285 x 240
MA 2113/D/H/S-10/ VPC-G12x-18	37799	Standard	VIRGINIA PANEL	10	2,000	15	- 648 x 618 x 270 - 648 x 564 x 657	440 x 310
MA 2113T/D/H/2x S-5/ VPC-G12x-18	57940	Tandem	VIRGINIA PANEL	2x 5	2,000	15	- 648 x 564 x 262 - 648 x 564 x 583	2x 150 x 240
MA 2114/D/H/S-10/HG/ VPC-G14	59730	Tall housing	VIRGINIA PANEL	10	2,000	15	- 759 x 675 x 370 - 759 x 621 x 753	540 x 310
MA 2113/D/H/S-10/HG/ VPC-G18x	51346	Tall housing	VIRGINIA PANEL	10	2,000	15	- 658 x 635 x 362 - 658 x 581 x 749	440 x 310
MA 2113/D/H/S-10/HG/ VPC-G20x	49480	Tall housing	VIRGINIA PANEL	10	2,000	15	- 658 x 675 x 362 - 658 x 621 x 749	440 x 310

# MA 32xx

## Manual interchangeable kit test fixture for mass test

Size
 <p>MA 3211</p>
 <p>MA 3212</p>
 <p>MA 3213</p>
 <p>Manual test fixture 3213T</p>
 <p>MA 3214</p>

### Usage

Test fixtures of MA 32xx series are suitable for contacting electronic units such as printed circuit boards (PCBs) with high quantities (mass test) and a large number of versions. The test fixtures are designed as interchangeable kit systems, are connected to an existing test system and operated with exchangeable kits that are specially designed for the electronic unit to be tested.

### Features

- Robust drive optimised for rough test use
- Interchangeable kit system
- High contact force of up to 2,000 N
- High parallel stroke of 22 mm
- Energy-saving, shock-absorbing opening mechanism
- Modularly configurable internal interface
- Exchangeable kits, can be installed quickly without tools
- Exchangeable kits, can be used without readjustment
- Pressure frame unit and probe plate can be screwed with stacking screws, to form a unit with protected probe field (storage/transport)

### Life span

- 2,000,000 load cycles (laboratory conditions)  
The life span is determined in the laboratory using fully automatic, computer-controlled endurance test stations under full load. Since the life span depends on many different factors and in particular on the individual test application, INGUN does not guarantee the actual duration of use in the test field.

### Internal interface

The unloaded internal interface is to be equipped with interface blocks. Interface blocks can be found from page 155 onwards.

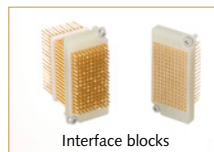

### Functional units

Stiffener bars and numerous other functional units for extension of functionality as required can be found from page 64 onwards.



### Customisation

INGUN provides customising documents for customisation. The exchangeable kits are according to customising guidelines **info 1317**.



Starter kits for customising on site and other customising accessories, such as pushrods, PCB support pins, tooling pins, pre-centring units, marking units, and test plugs, can be found from page 153 onwards.

### MA 32xx - test fixture

MA 3211	50
MA 3212	51
MA 3213	52
MA 3213T	53
MA 3214	54

### ATS MAxx - exchangeable kits

ATS MA11/S-5	50, 53
ATS MA11	50, 53
ATS MA11/S-5/ESD	50, 53
ATS MA11/ESD	50, 53
ATS MA11/S-5/HF	50, 53
ATS MA11/HF	50, 53
ATS MA12/S-7	51
ATS MA12	51
ATS MA12/S-7/ESD	51
ATS MA12/ESD	51
ATS MA12/S-7/HF	51
ATS MA12/HF	51
ATS MA2112/S-7/SN	51
ATS MA13/S-10	52
ATS MA13	52
ATS MA13/S-10/ESD	52
ATS MA13/ESD	52
ATS MA13/S-10/HF	52
ATS MA13/HF	52
ATS MA14/S-10	54
ATS MA14	54
ATS MA14/S-10/ESD	54
ATS MA14/ESD	54

### Note

See page 55 for overview and comparison table

# MA 3211

Manual interchangeable test fixture for mass testing without test system interface

Series: MA xxxx  
 Contact force: 2,000 N  
 Parallel stroke: 22 mm  
 Maximum usable area: 150 x 240 mm  
 Load cycles: 2,000,000 (laboratory conditions)



Basic unit  
with **standard housing**

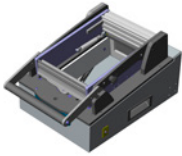

MA 3211/D/H/S-5

Exchangeable kits **with**  
internal SB interface

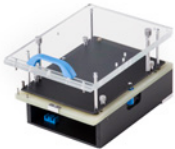

ATS MA11/S-5

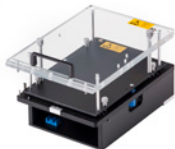

ATS MA11/S-5/ESD



ATS MA11/S-5/HF (\*)

Exchangeable kits **without**  
internal interface

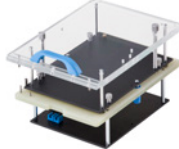

ATS MA11

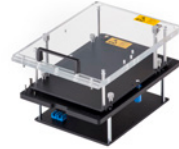

ATS MA11/ESD

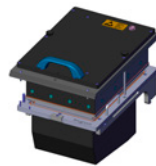

ATS MA11/HF (\*)

## Features

- Fully closed pressure frame
- Exchangeable kits with or without internal interface
- Single-sided, double-sided, dual-stage contacting

## Technical specifications

### Basic unit

- Outer dimensions, closed (W x D x H):
  - MA 3211/D/H/S-5: approx. 320 x 533 x 270 mm
- Outer dimensions, open (W x D x H):
  - MA 3211/D/H/S-5: approx. 320 x 464 x 637 mm
- Pressure frame unit opening angle: approx. 75 °
- Pressure frame unit clamping force: approx. 70 N (at full load)

### Exchangeable kit

- Usable area ATS (W x D):
  - ATS MA11/S-5: approx. 150 x 240 mm
  - ATS MA11: approx. 150 x 240 mm
  - ATS MA11/S-5/ESD: approx. 150 x 240 mm
  - ATS MA11/ESD: approx. 150 x 240 mm
  - ATS MA11/S-5/HF: approx. 100 x 160 mm
  - ATS MA11/HF: approx. 100 x 160 mm
- Free height above PCB: approx. 58 mm
- Pushrod length: 60 mm
- GKS installation height, bottom: 10.5 mm
- GKS installation height, top: 16.0 mm
- GKS installation height 2-stage, bottom: 10.5 | 16.0 mm
- GKS theoretical working stroke: 3 mm (bottom), 3.5 mm (top)

### General

- Number of interface blocks: max. 5
- Operating temperature range: + 10 °C to + 60 °C

### Internal interface

- ATS MA11/S-5(/ESD),  
ATS MA11/S-5/HF: max. 5 interface blocks SB-P (DUT side) for max. 850 signals (not included), e.g.

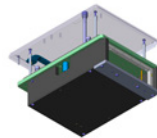

### Note:

Basic units are fitted with SB-T (test system side) interface blocks. More interface blocks can be found from page 155 onwards.

## Ordering information

Basic unit		
Part no.:	43950	MA 3211/D/H/S-5
		Manual interchangeable kit test fixture
Exchangeable kits		
Part no.:	45898-KIT	ATS MA11/S-5
		Standard exchangeable kit with internal interface
Part no.:	45900-KIT	ATS MA11
		Standard exchangeable kit without internal interface
Part no.:	46026-KIT	ATS MA11/S-5/ESD
		ESD exchangeable kit with internal interface
Part no.:	46248-KIT	ATS MA11/ESD
		ESD exchangeable kit without internal interface
Part no.:	54111	ATS MA11/S-5/HF (*)
		RF exchangeable kit with internal interface
Part no.:	54011	ATS MA11/HF (*)
		RF exchangeable kit without internal interface

Parts with the ending "-KIT" are delivered unassembled. This enables immediate DUT-specific processing.

\* RF exchangeable kits: Further information about the RF exchangeable kits can be found from page 58 onwards.



Basic unit  
with standard housing

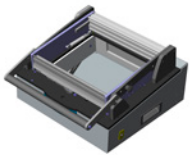

MA 3212/D/H/S-7

Basic unit  
with tall housing

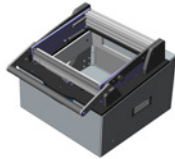

MA 3212/D/H/S-7/HG

Exchangeable kits with  
internal SB interface

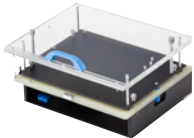

ATS MA12/S-7

Exchangeable kits without  
internal interface

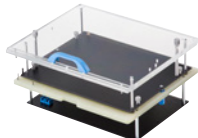

ATS MA12

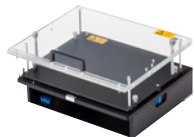

ATS MA12/S-7/ESD

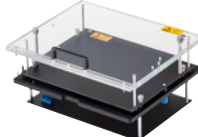

ATS MA12/ESD

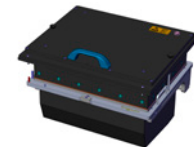

ATS MA12/S-7/HF (\*)

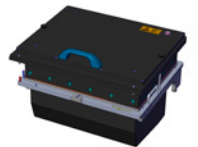

ATS MA12/HF (\*)

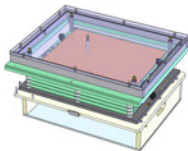

ATS MA2112/S-7/SN

**Rigid pin customisation:**  
 - Contact area:  $\varnothing = 0.30$  mm  
 - Minimum grid: 0.50 mm  
 (without PCB tolerances,  
 when customised by INGUN)  
 (see page 20)

## Features

- Fully closed pressure frame
- Exchangeable kits with or without internal interface
- Single-sided, double-sided, 2-stage or rigid pin contacting

## Technical specifications

### Basic unit

- Outer dimensions, closed (W x D x H):
  - MA 3212/D/H/S-7: approx. 492 x 533 x 270 mm
  - MA 3212/D/H/S-7/HG: approx. 492 x 533 x 370 mm
- Outer dimensions, open (W x D x H):
  - MA 3212/D/H/S-7: approx. 492 x 464 x 607 mm
  - MA 3212/D/H/S-7/HG: approx. 492 x 464 x 707 mm
- Pressure frame unit opening angle: approx. 75 °
- Pressure frame unit clamping force: approx. 70 N (at full load)

### Exchangeable kit

- Usable area ATS (W x D):
  - ATS MA12/S-7: approx. 285 x 240 mm
  - ATS MA12: approx. 285 x 240 mm
  - ATS MA12/S-7/ESD: approx. 285 x 240 mm
  - ATS MA12/ESD: approx. 285 x 240 mm
  - ATS MA12/S-7/HF: approx. 215 x 180 mm
  - ATS MA12/HF: approx. 215 x 180 mm
  - ATS MA2112/S-7/SN: approx. 225 x 220 mm
- Free overall height above PCB: approx. 58 mm | approx. 34 mm (ATS/SN)
- Pushrod length: 60 mm | 36.4 mm (ATS/SN)
- GKS installation height, bottom: 10.5 mm
- GKS installation height, top: 16.0 mm
- GKS installation height 2-stage, bottom: 10.5 | 16.0 mm
- GKS theoretical working stroke: 3 mm (bottom), 3.5 mm (top)

### General

- Number of interface blocks: max. 7
- Operating temperature range: + 10 °C to + 60 °C

### Internal interface

- ATS MA12/S-7(/ESD),  
 ATS MA12/S-7/HF,  
 ATS MA2112/S-7/SN: max. 7 interface blocks  
 SB-P (DUT side) for  
 max. 1,190 signals  
 (not included), e.g.

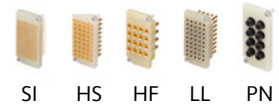
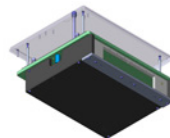

### Note:

Basic units are fitted with SB-T (test system side) interface blocks.  
 More interface blocks can be found from page 155 onwards.

## Ordering information

Basic units			
Part no.:	43630	MA 3212/D/H/S-7	Manual interchangeable kit test fixture
Part no.:	55760	MA 3212/D/H/S-7/HG	Manual interchangeable test fixture with tall housing
Exchangeable kits			
Part no.:	45903-KIT	ATS MA12/S-7	Standard exchangeable kit with internal interface
Part no.:	45904-KIT	ATS MA12	Standard exchangeable kit without internal interface
Part no.:	46236-KIT	ATS MA12/S-7/ESD	ESD exchangeable kit with internal interface
Part no.:	46250-KIT	ATS MA12/ESD	ESD exchangeable kit without internal interface
Part no.:	54112	ATS MA12/S-7/HF (*)	RF exchangeable kit with internal interface
Part no.:	54012	ATS MA12/HF (*)	RF exchangeable kit without internal interface
Part no.:	33335	ATS MA2112/S-7/SN	Rigid pin exchangeable kit with internal interface

Parts with the ending "-KIT" are delivered unassembled. This enables immediate DUT-specific processing.

\* RF exchangeable kits: Further information about the RF exchangeable kits can be found from page 58 onwards.

# MA 3213

Manual interchangeable test fixture for mass testing without test system interface

Series: MA xxxx  
 Contact force: 2,000 N  
 Parallel stroke: 22 mm  
 Maximum usable area: 440 x 310 mm  
 Load cycles: 2,000,000 (laboratory conditions)



Basic unit with standard housing

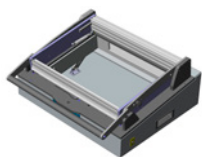

MA 3213/D/H/S-10

Basic unit with tall housing

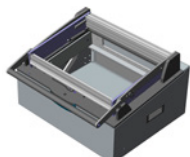

MA 3213/D/H/S-10/HG

Exchangeable kits with internal SB interface

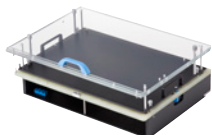

ATS MA13/S-10

Exchangeable kits without internal interface



ATS MA13



ATS MA13/S-10/ESD

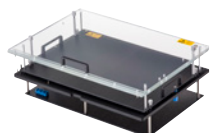

ATS MA13/ESD



ATS MA13/S-10/HF (\*)



ATS MA13/HF (\*)

## Features

- Fully closed pressure frame
- Exchangeable kits with or without internal interface
- Single-sided, double-sided, dual-stage contacting

## Technical specifications

### Basic unit

- Outer dimensions, closed (W x D x H):
  - MA 3213/D/H/S-10: approx. 648 x 601 x 270 mm
  - MA 3213/D/H/S-10/HG: approx. 648 x 601 x 370 mm
- Outer dimensions, open (W x D x H):
  - MA 3213/D/H/S-10: approx. 648 x 533 x 670 mm
  - MA 3213/D/H/S-10/HG: approx. 648 x 533 x 770 mm
- Pressure frame unit opening angle: approx. 75 °
- Pressure frame unit clamping force: approx. 70 N (at full load)

### Exchangeable kit

- Usable area ATS (W x D):
  - ATS MA13/S-10: approx. 440 x 310 mm
  - ATS MA13: approx. 440 x 310 mm
  - ATS MA13/S-10/ESD: approx. 440 x 310 mm
  - ATS MA13/ESD: approx. 440 x 310 mm
  - ATS MA13/S-10/HF: approx. 375 x 240 mm
  - ATS MA13/HF: approx. 375 x 240 mm
- Free height above PCB: approx. 58 mm
- Pushrod length: 60 mm
- GKS installation height, bottom: 10.5 mm
- GKS installation height, top: 16.0 mm
- GKS installation height 2-stage, bottom: 10.5 | 16.0 mm
- GKS theoretical working stroke: 3 mm (bottom), 3.5 mm (top)

### General

- Number of interface blocks: max. 10
- Operating temperature range: + 10 °C to + 60 °C

### Internal interface

- ATS MA13/S-10(/ESD), ATS MA13/S-10/HF: max. 10 interface blocks SB-P (DUT side) for max. 1,700 signals (not included), e.g.

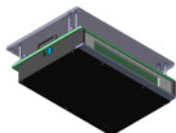

### Note:

Basic units are fitted with SB-T (test system side) interface blocks. More interface blocks can be found from page 155 onwards.

## Ordering information

Basic units			
Part no.:	43580	MA 3213/D/H/S-10	Manual interchangeable kit test fixture
Part no.:	49580	MA 3213/D/H/S-10/HG	Manual interchangeable test fixture with tall housing
Exchangeable kits			
Part no.:	45908-KIT	ATS MA13/S-10	Standard exchangeable kit with internal interface
Part no.:	45980-KIT	ATS MA13	Standard exchangeable kit without internal interface
Part no.:	46239-KIT	ATS MA13/S-10/ESD	ESD exchangeable kit with internal interface
Part no.:	46254-KIT	ATS MA13/ESD	ESD exchangeable kit without internal interface
Part no.:	54113	ATS MA13/S-10/HF (*)	RF exchangeable kit with internal interface
Part no.:	54013	ATS MA13/HF (*)	RF exchangeable kit without internal interface

Parts with the ending "-KIT" are delivered unassembled. This enables immediate DUT-specific processing.

\* RF exchangeable kits: Further information about the RF exchangeable kits can be found from page 58 onwards.

Basic unit  
 with standard housing

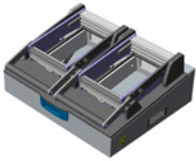

MA 3213T/D/H/2x S-5

Exchangeable kits **with**  
 internal SB interface

Exchangeable kits **without**  
 internal interface

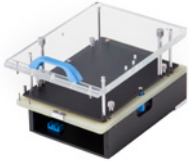

ATS MA11/S-5

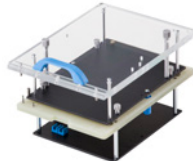

ATS MA11

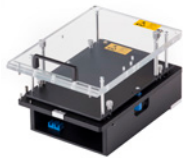

ATS MA11/S-5/ESD

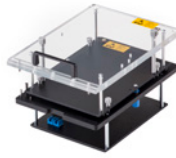

ATS MA11/ESD

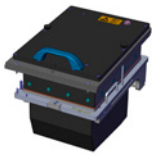

ATS MA11/S-5/HF (\*)

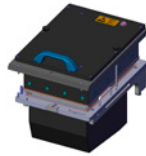

ATS MA11/HF (\*)

**Features**

- Two drive units on one housing, thereby reducing overall test time
- Fully closed pressure frame
- Exchangeable kits with or without internal interface
- Single-sided, double-sided, dual-stage contacting

**Technical specifications**

**Basic unit**

- Outer dimensions, closed (W x D x H):  
 - MA 3213T/D/H/2x S-5: approx. 648 x 533 x 270 mm
- Outer dimensions, open (W x D x H):  
 - MA 3213T/D/H/2x S-5: approx. 648 x 533 x 614 mm
- Pressure frame unit opening angle: approx. 75 °
- Pressure frame unit clamping force: approx. 70 N (at full load)

**Exchangeable kit**

- Usable area ATS (W x D):
- ATS MA11/S-5: approx. 150 x 240 mm
- ATS MA11: approx. 150 x 240 mm
- ATS MA11/S-5/ESD: approx. 150 x 240 mm
- ATS MA11/ESD: approx. 150 x 240 mm
- ATS MA11/S-5/HF: approx. 100 x 160 mm
- ATS MA11/HF: approx. 100 x 160 mm
- Free height above PCB: approx. 58 mm
- Pushrod length: 60 mm
- GKS installation height, bottom: 10.5 mm
- GKS installation height, top: 16.0 mm
- GKS installation height 2-stage, bottom: 10.5 | 16.0 mm
- GKS theoretical working stroke: 3 mm (bottom), 3.5 mm (top)

**General**

- Number of interface blocks: max. 2x 5 (basic unit)
- Operating temperature range: + 10 °C to + 60 °C

**Internal interface**

- ATS MA11/S-5(/ESD),  
 ATS MA11/S-5/HF: max. 5 interface blocks  
 SB-P (DUT side) for  
 max. 850 signals  
 (not included), e.g.

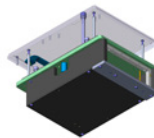

SI HS HF LL PN

**Note:**

Basic units are fitted with SB-T (test system side) interface blocks.  
 More interface blocks can be found from page 155 onwards.

**Ordering information**

Basic unit		
Part no.:	43970	MA 3213T/D/H/2x S-5 Manual interchangeable kit test fixture

Exchangeable kits		
Part no.:	45898-KIT	ATS MA11/S-5 Standard exchangeable kit with internal interface
Part no.:	45900-KIT	ATS MA11 Standard exchangeable kit without internal interface
Part no.:	46026-KIT	ATS MA11/S-5/ESD ESD exchangeable kit with internal interface
Part no.:	46248-KIT	ATS MA11/ESD ESD exchangeable kit without internal interface
Part no.:	54111	ATS MA11/S-5/HF (*) RF exchangeable kit with internal interface
Part no.:	54011	ATS MA11/HF (*) RF exchangeable kit without internal interface

For tandem operation, two exchangeable kits of size ATS MA11 are required.

Parts with the ending "-KIT" are delivered unassembled. This enables immediate DUT-specific processing.

\* RF exchangeable kits: Further information about the RF exchangeable kits can be found from page 58 onwards.

# MA 3214

Manual interchangeable test fixture for mass testing without test system interface

Series: MA xxxx  
 Contact force: 2,000 N  
 Parallel stroke: 22 mm  
 Maximum usable area: 540 x 310 mm  
 Load cycles: 2,000,000 (laboratory conditions)



Basic unit with standard housing

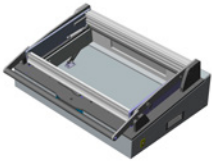

MA 3214/D/H/S-10

Exchangeable kits with internal SB interface

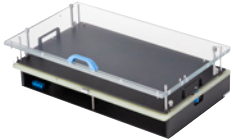

ATS MA14/S-10



ATS MA14/S-10/ESD

Exchangeable kits without internal interface

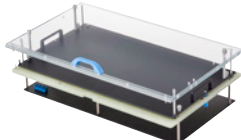

ATS MA14



ATS MA14/ESD

## Features

- Fully closed pressure frame
- Exchangeable kits with or without internal interface
- Single-sided, double-sided, dual-stage contacting

## Technical specifications

### Basic unit

- Outer dimensions, closed (W x D x H):
  - MA 3214/D/H/S-10: approx. 748 x 603 x 270 mm
- Outer dimensions, open (W x D x H):
  - MA 3214/D/H/S-10: approx. 748 x 533 x 670 mm
- Pressure frame unit opening angle: approx. 75 °
- Pressure frame unit clamping force: approx. 70 N (at full load)

### Exchangeable kit

- Usable area ATS (W x D):
  - ATS MA14/S-10: approx. 540 x 310 mm
  - ATS MA14: approx. 540 x 310 mm
  - ATS MA14/S-10/ESD: approx. 540 x 310 mm
  - ATS MA14/ESD: approx. 540 x 310 mm
- Free height above PCB: approx. 58 mm
- Pushrod length: 60 mm
- GKS installation height, bottom: 10.5 mm
- GKS installation height, top: 16.0 mm
- GKS installation height 2-stage, bottom: 10.5 | 16.0 mm
- GKS theoretical working stroke: 3 mm (bottom), 3.5 mm (top)

### General

- Number of interface blocks: max. 10
- Operating temperature range: + 10 °C to + 60 °C

### Internal interface

- ATS MA14/S-10(/ESD): max. 10 interface blocks SB-P (DUT side) for max. 1,700 signals (not included), e.g.

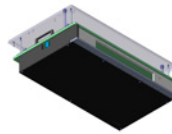

### Note:

Basic units are fitted with SB-T (test system side) interface blocks. More interface blocks can be found from page 155 onwards.

## Ordering information

Basic unit		
Part no.:	43960	MA 3214/D/H/S-10
		Manual interchangeable kit test fixture
Exchangeable kits		
Part no.:	45983-KIT	ATS MA14/S-10
		Standard exchangeable kit with internal interface
Part no.:	45985-KIT	ATS MA14
		Standard exchangeable kit without internal interface
Part no.:	46242-KIT	ATS MA14/S-10/ESD
		ESD exchangeable kit with internal interface
Part no.:	46257-KIT	ATS MA14/ESD
		ESD exchangeable kit without internal interface













Parts with the ending "-KIT" are delivered unassembled. This enables immediate DUT-specific processing.

Description	Part number	Version	Test system interface	Max. interface blocks	Max. contact force [N]	Parallel stroke [mm]	Outer dimensions - closed - open (W x D x H mm)	Maximum usable area ATS MAxx (W x D mm)
<b>MA 3211/D/H/S-5</b>	43950	Standard	-	5	2,000	22	- 320 x 533 x 270 - 320 x 464 x 637	150 x 240
<b>MA 3212/D/H/S-7</b>	43630	Standard	-	7	2,000	22	- 492 x 533 x 270 - 492 x 464 x 607	285 x 240
<b>MA 3212/D/H/S-7/HG</b>	55760	Tall housing	-	7	2,000	22	- 492 x 533 x 370 - 492 x 464 x 707	285 x 240
<b>MA 3213/D/H/S-10</b>	43580	Standard	-	10	2,000	22	- 648 x 601 x 270 - 648 x 533 x 670	440 x 310
<b>MA 3213/D/H/S-10/HG</b>	49580	Tall housing	-	10	2,000	22	- 648 x 601 x 370 - 648 x 533 x 770	440 x 310
<b>MA 3213T/D/H/2x S-5</b>	43970	Tandem	-	2x 5	2,000	22	- 648 x 533 x 270 - 648 x 533 x 614	2x 150 x 240
<b>MA 3214/D/H/S-10</b>	43960	Standard	-	10	2,000	22	- 748 x 603 x 270 - 748 x 533 x 670	540 x 310



# MA xxxx / ATS MAxx

Overview of part numbers for manual stand-alone test fixtures, interchangeable test fixtures & exchangeable kits

MA size	MA xxxx Test fixture (without test system interface)			MA 20xx / MA 21xx Test fixture (with test system interface)												
	MA 20xx	MA 21xx	MA 32xx													
MA xx09		34340														
MA xx11	48590	31730	43950													
MA xx11/HG (Tall housing)		33420														
MA xx12	48530	32660	43630	33750		33045	32958		40978	32735	37970 (table install.)	32965	33464	44880	37745	
MA xx12/HG (Tall housing)	101930	33460	55760					33480								
MA xx12/HF (Radio frequency)	54818															
MA xx13	48620	32500	43580	37736	42600		33443			38871	32701 (table install.)	33290	33444	33764		
MA xx13/HG (Tall housing)	100720	32700	49580						47540							
MA xx13T	100985	32300	43970				33380			48850		33439	33440	44630		
MA xx13T/HG (Tall housing)		36666														
MA xx14	100690	34350	43960													
MA xx14/HG (Tall housing)		42290														



# RF exchangeable kits ATS MAxx/HF for manual radio frequency test fixtures

Manual radio frequency test fixtures are designed as interchangeable kit systems. Radio frequency shielded replacement kits **ATS MAxx/HF** are combined with basic units from the manual test fixture **MA 21xx** or **MA 32xx series**.

The precision-made **exchangeable kits** can be prepared for new testing tasks without tools and without readjustment in seconds. They are available in sizes **ATS MA11/HF**, **ATS MA12/HF**, and **ATS MA13/HF** with or without internal interface.

The high-precision RF chambers (copper covers) provide outstanding **screening attenuation** in the frequency range up

to 6 GHz. Therefore, they ensure not only RF-compatible shielding of the highly sensitive RF boards against signal interference from the outside, but also the protection of operating personnel against RF fields emitted from the inside the fixture.

Various EMC-compatible **RF connectors**, for mounting on the RF interface to transfer signals to and from the screened area, are available to connect the RF board to the measuring system.

To set up an internal high network, **absorber mats (HF-A)** for different frequencies are available.

## RF test fixture: Combination of RF exchangeable kit and MA xxxx-basic unit

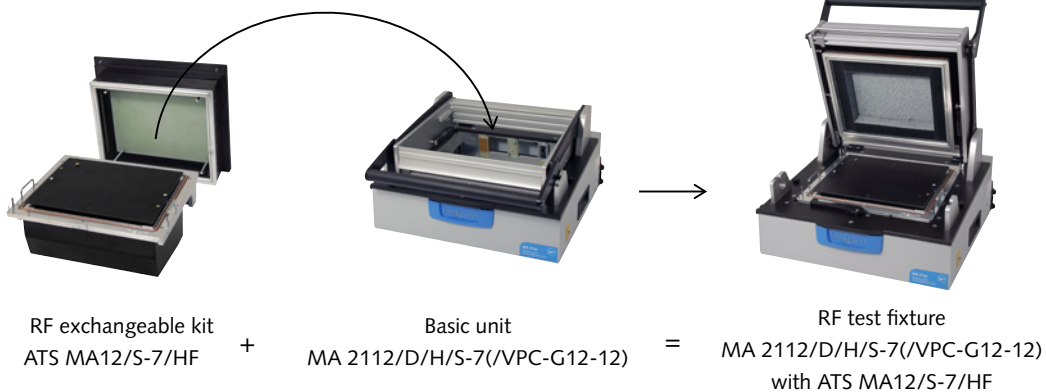

## RF exchangeable kits: screening attenuation

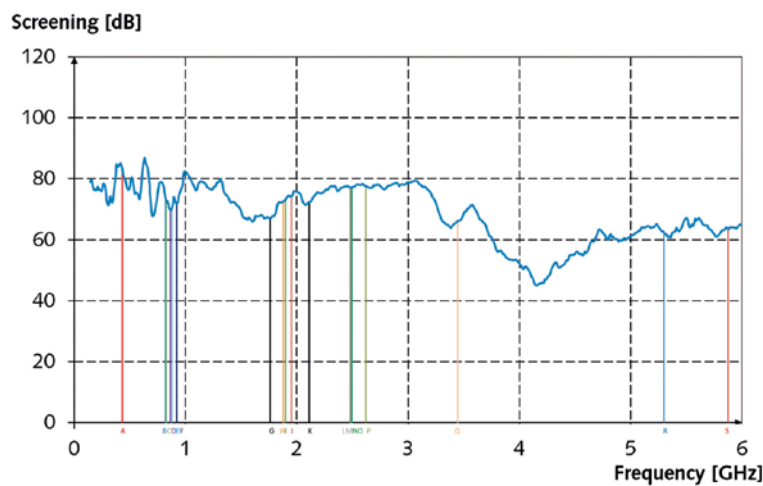

	Radio network	f <sub>min</sub> [MHz]	f <sub>max</sub> [MHz]	Screening attenuation min [dB]
A	ISM	433	435	83
B	LTE (Downlink)	791	821	74
C	LTE (Uplink)	832	862	73
D	RFID	865	868	70
E	GSM 900 (Uplink)	880	915	71
F	GSM 900 (Downlink)	925	960	72
G	GSM 1800, LTE (Uplink)	1710	1785	67
H	GSM 1800, LTE (Downlink)	1805	1880	72
I	DECT	1880	1900	73
J	UMTS (Uplink)	1920	1980	74
K	UMTS (Downlink)	2110	2170	72
L	WLAN-1	2400	2485	77
M	ISM, ZigBee	2400	2500	77
N	Bluetooth	2402	2480	77
O	LTE (Uplink)	2500	2570	77
P	LTE (Downlink)	2620	2690	75
Q	WiMAX	3410	3594	66
R	WLAN-2	5150	5725	62
S	ISM	5725	5875	61



**Usage**

Radio frequency exchangeable kits ATS MAxx/HF are suitable for the precise, reliable contacting of highly sensitive RF modules and for interference-free measurement of high frequency signals. Depending on the basic unit from either the MA 21xx or MA 32xx series used, RF modules with medium or high quantities (series or mass testing) and a large number of versions can be tested.

**Features**

- Outstanding screening attenuation in the frequency range up to 6 GHz
- Interference-proof measurement of high frequency signals
- RF exchangeable kits with or without internal interface
- RF exchangeable kits can be installed quickly without tools
- RF exchangeable kits, can be used without readjustment
- Radio frequency and RF-compliant shielding against external interference signals
- Protection of operating personnel from high frequency fields radiating from within the fixture
- Standardised contacting with geometrically aligned radio frequency test probes for as low-reflection a transmission as possible
- Numerous EMC-compatible RF transfers for connecting the RF module to the measuring system
- RF absorber for different frequencies to establish an internal radio network

**Radio frequency interface**

For the radio frequency interface, we recommend the use of EMC-compatible RF transfers. RF transfers can be found from page 61 onwards.



**Internal interface**

The unloaded internal interface is to be equipped with interface blocks. Interface blocks can be found from page 155 onwards.

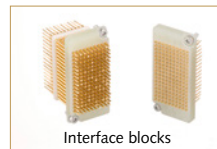

**Customisation**

INGUN provides customising documents for customisation. The exchangeable kits are according to customising guidelines **info 1317**.



Starter kits for customising on site and other customising accessories, such as pushrods, PCB support pins, tooling pins, pre-centring pins, marking units, and test plugs, can be found from page 153 onwards.

**ATS MAxx/HF Exchangeable kits**

ATS MA11/HF	60
ATS MA12/HF	60
ATS MA13/HF	60

**RF wire mesh exchangeable kits**

ETK-HGD-AT SMA11/HF	60
ETK-HGD-AT SMA12/HF	60
ETK-HGD-AT SMA13/HF	60

**RF transfer (HF-U)**

HF-U-SMA	61
HF-U-MCX	61
HF-U-N	61
HF-U-BNC-04GHz	61
HF U-BNC-03GHz	61
HF U-SUBD-09-830pF	61
HF U-SUBD-15-830pF	61
HF U-SUBD-25-830pF	61
HF U-SUBD-37-830pF	61
HF U-SUBD-50-830pF	61
HF U-SUBD-09-100pF	61
HF-U-USB2.0	61
HF U-USB3.0	61
HF U-RJ45	62
HF-U-D-8,5	62
HF-U-D-8,5-QS4	62

**RF Absorbers (HF-A)**

HF A-AT SMA11	63
HF A-AT SMA12	63
HF A-AT SMA13	63

# ATS MAxx/HF

Radio frequency exchangeable kits for manual interchangeable test fixture MA 21xx or MA 32xx

Series: ATS MAxx/HF

Compatible test fixture: MA 21xx | MA 32xx

Parallel stroke: 15 mm | 22 mm

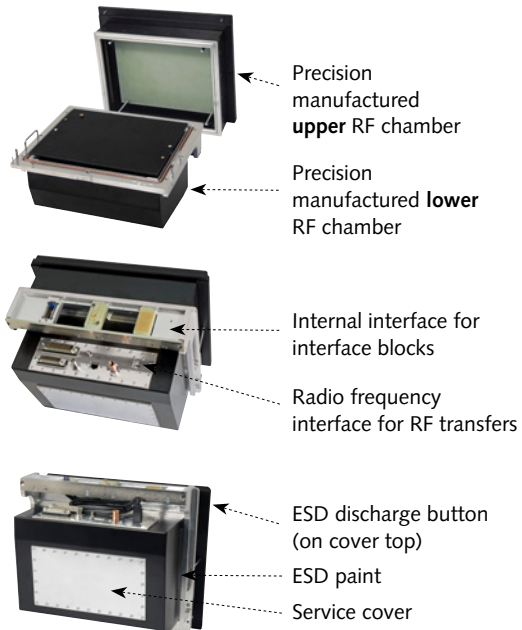

By loosening the service cover, you gain access to the interior of the lower RF chamber without removing the top-mounted DUT-specific customisations. This allows easy debugging in the disassembled state.

Exchangeable kits **without** internal interface

Exchangeable kits **with** internal SB interface



## Features

- Exchangeable kits with integrated high frequency interface and removable service cover
- Exchangeable kits with or without internal interface
- ESD-prepared design, with ESD-coated RF covers, ESD-coated probe plate, ESD-compliant pressure plate, and integrated ESD discharge push button
- Single-sided or double-sided contacting

## Technical specifications

### Exchangeable kit

- Usable area ATS (W x D):
  - ATS MA11/HF: approx. 100 x 160 mm
  - ATS MA11/S-5/HF: approx. 100 x 160 mm
  - ATS MA12/HF: approx. 215 x 180 mm
  - ATS MA12/S-7/HF: approx. 215 x 180 mm
  - ATS MA13/HF: approx. 375 x 240 mm
  - ATS MA13/S-10/HF: approx. 375 x 240 mm
- Free height above PCB: approx. 58 mm
- Pushrod length: 60 mm
- GKS installation height, bottom: 10.5 mm
- GKS installation height, top: 16.0 mm
- GKS theoretical working stroke: 3 mm (bottom), 3.5 mm (top)

### General

- Number of interface blocks:
  - ATS MA11/HF: 0
  - ATS MA11/S-5/HF: max. 5
  - ATS MA12/HF: 0
  - ATS MA12/S-7/HF: max. 7
  - ATS MA13/HF: 0
  - ATS MA13/S-10/HF: max. 10
- Operating temperature range: + 10 °C to + 60 °C

When using the RF exchangeable kits (ATS MAxx / HF), we recommend using the following gas pressure springs (GDF) in the fixture's basic unit:

ATS MAxx/HF	GDF - left mounted (dynamically absorbed)	GDF - right mounted
Part no.: 54011, 54111	Part no.: 37967 (200 N)	Part no.: 31788 (200 N)
Part no.: 54012, 54112	Part no.: 37967 (200 N)	Part no.: 35469 (300 N)
Part no.: 54013, 54113	Part no.: 49316 (300 N)	Part no.: 35469 (300 N)

### Note:

Dual-stage contacting is not possible with RF exchangeable kits.

## Ordering information

Radio frequency exchangeable kits		
Part no.: 54011	ATS MA11/HF	RF exchangeable kit without internal interface for MA 21/3211, MA 21/3213T
Part no.: 54111	ATS MA11/S-5/HF	RF exchangeable kit with internal interface for MA 21/3211, MA 21/3213T
Part no.: 54012	ATS MA12/HF	RF exchangeable kit without internal interface for MA 21/3212
Part no.: 54112	ATS MA12/S-7/HF	RF exchangeable kit with internal interface for MA 21/3212
Part no.: 54013	ATS MA13/HF	RF exchangeable kit without internal interface for MA 21/3213
Part no.: 54113	ATS MA13/S-10/HF	RF exchangeable kit with internal interface for MA 21/3213

Replacement kits		
Part no.: 101783	ETK-HGD-ATSMA11/HF	RF sealing kit for ATS MA11/(S-5)/HF
Part no.: 101784	ETK-HGD-ATSMA12/HF	RF sealing kit for ATS MA12/(S-7)/HF
Part no.: 101787	ETK-HGD-ATSMA13/HF	RF sealing kit for ATS MA13/(S-10)/HF



**ESD-compliant RF transfer (HF U) for the high frequency interface**

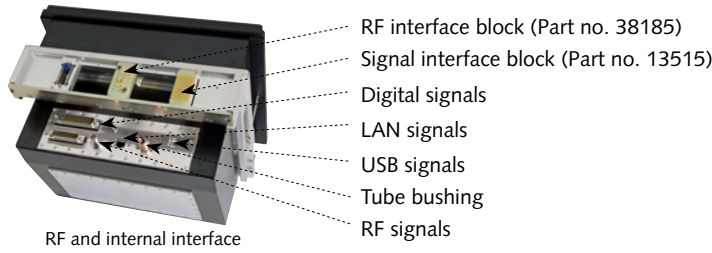

Contacting of RF boards is mainly done with geometrically aligned INGUN RF probes, which provide the best possible semi-anechoic, non-dissipative transfer of the RF signals to be measured. EMC-compatible RF connectors, for mounting on the **RF interface** to transfer signals to and from the shielded area, are available to connect the RF board to the measuring system.

**RF signals**

By using coaxial RF transfer components, radio frequency signals can be transferred with almost no loss between the RF chamber and the exterior housing. Depending on the type of interface, the transfer is carried out with an impedance of 50 Ω or 75 Ω up to 18 GHz.



HF-U-SMA-18GHz-50Ohm-F-F  
 Part no.: 41661



HF U-BNC-04GHz-50Ohm-F-F  
 Part no.: 43460

**Ordering information**

Part no.:	41661	HF-U-SMA-18GHz-50Ohm-F-F
Part no.:	33800	HF-U-MCX-06GHz-50Ohm-F-F
Part no.:	43462	HF-U-N-18GHz-50Ohm-F-F
Part no.:	43460	HF-U-BNC-04GHz-50Ohm-F-F
Part no.:	43461	HF-U-BNC-03GHz-75Ohm-F-F

**Low voltage and serial signals (e.g. RS-232)**

Low-voltage and serial signals are transmitted using a sub-D transfer with integrated inference filter (frequency limit 3 dB: 8 MHz). The C-filter has a capacity of 830 pF and ensures that unwanted signals cannot pass through the shielded area. Delivery includes a Sub-D connector, RF seal, 2 connector plugs, and housing.



HF-U-SUBD-25-830pF-WW  
 Part no.: 53084

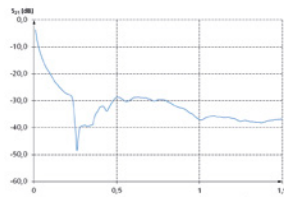

**Ordering information**

Part no.:	53087	HF-U-SUBD-09-830pF-WW
Part no.:	53083	HF-U-SUBD-15-830pF-WW
Part no.:	53084	HF-U-SUBD-25-830pF-WW
Part no.:	53085	HF-U-SUBD-37-830pF-WW
Part no.:	53086	HF-U-SUBD-50-830pF-WW

**Bus and HSD signals (e. g. I<sup>2</sup>C) up to 150 Mbps**

Bus, HSD, 10/100 Ethernet and USB1.x signals are transmitted using a sub-D transfer with integrated inference filter (frequency limit 3 dB: 30 MHz). The C-filter has a capacity of 100 pF and ensures that unwanted signals cannot pass through the shielded area. Delivery includes a Sub-D connector, RF seal, 2 connector plugs, and housing.



HF U-SUBD-09-100pF-WW  
 Part no.: 51358

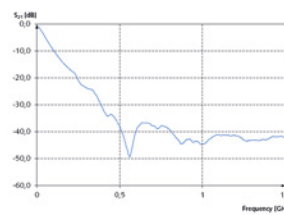

**Ordering information**

Part no.:	51358	HF-U-SUBD-09-100pF-WW
-----------	-------	-----------------------

**USB signals**

All applications with standard USB1 and USB2 require additional transfer filters. For transfers of the standard USB3, however, no filtering is necessary. This is to avoid any negative influence on the theoretically achievable bit rate of 5 Gbit/s. Delivery includes a USB filter (2x A female jack onto 2x A female jack) and screws.

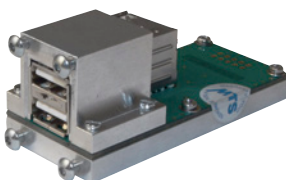

HF-U-USB2.0-AF-AF-2-SF  
 Part no.: 43488

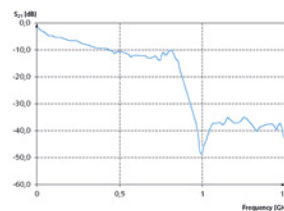

**Ordering information**

Part no.:	43488	HF-U-USB2.0-AF-AF-2-SF (filtered) - Type of filter: LC element - Attenuation (1 - 6 GHz): > 30 dB (typical) - Current capacity: max. 500 mA for 5 V DC - Maximum data rate: 480 Mbit/s
Part no.:	43489	HF-U-USB3.0-AF-AF-2 (not filtered)

## LAN signals

Feedthru filters are used to transfer LAN signals with 10, 100 or 1000 Mbit/s to and from the shielded area. Optimal attenuation of interfering signals with > 50 dB (typical) is typically achieved in the range 700 MHz to 6 GHz. Delivery includes LAN filter (RJ45 female jack onto RJ45 female jack), and screws.



HF-U-RJ45-LAN1000-F-F-SF  
Part no.: 48392

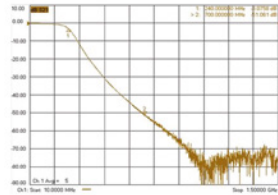

S<sub>21</sub>-Parameters

### Ordering information

Part no.: 48392	HF-U-RJ45-LAN1000-F-F-SF
- Type of filter:	LC element
- Attenuation (0.7 - 6 GHz):	> 50 dB (typical)
- Maximum data rate:	1,000 Mbit/s

## Tube bushings

Specialised tube bushing is used to install cables and tubing. This allows optical wave guides and compressed air tubing, among others, to be laid in the RF chamber without any negative influence on the screening attenuation below 8 GHz. Delivery includes a bushing, RF seal, and screws.



HF-U-D-8.5  
Part no.: 43490

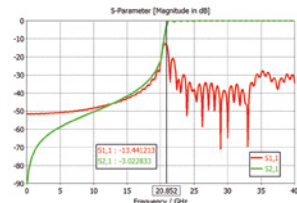

S<sub>21</sub>-Parameters  
S<sub>11</sub>-Parameters

### Ordering information

Part no.: 43490	HF-U-D-8.5
Part no.: 43665	HF-U-D-8,5-QS4

## Connection of the contact to the test system

The RF boards contacts are connected to the test system via the RF interface within the shielded area, and to the internal interface outside the shielded area.

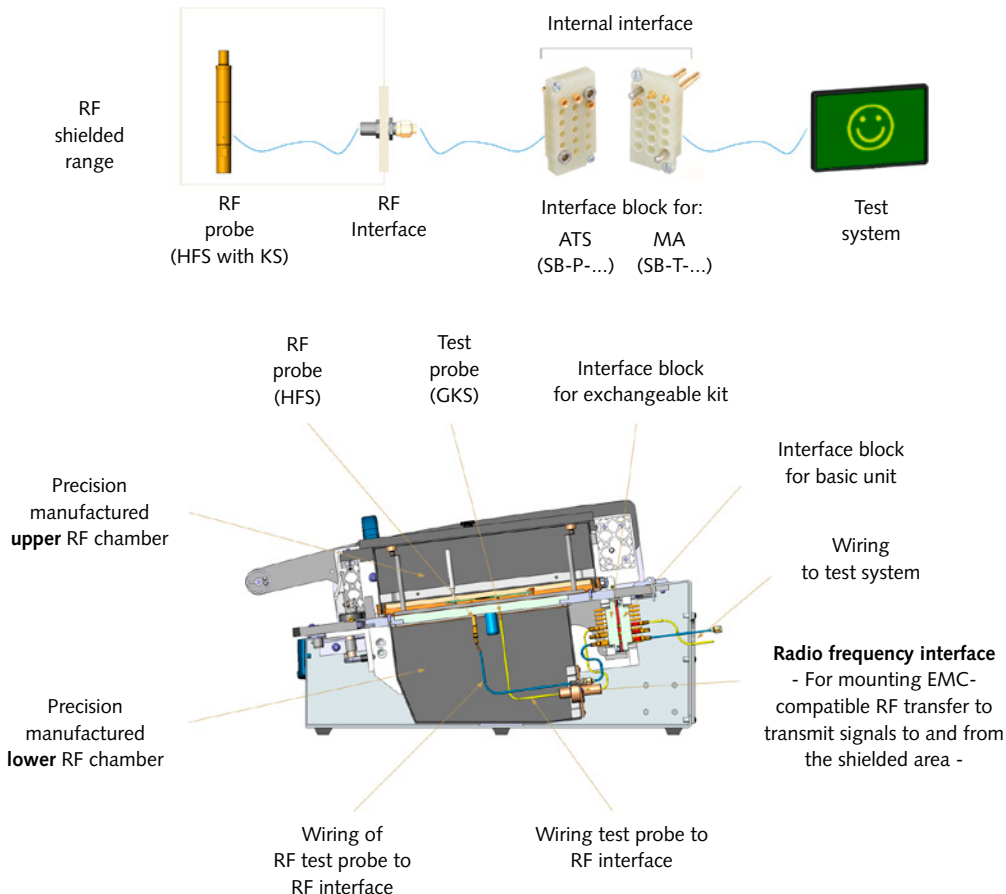

Cross section of RF test fixture with contacting and wiring

**Series:** HF-A  
**Frequencies:** From 2.4 GHz | from 3.5 GHz | from 7.5 GHz  
**Compatible exchangeable kits:** ATS MAxx/HF

RF absorber for radio frequency exchangeable kits  
 ATS MAxx/HF

RF test fixture  
 MA 2112/D/H/S-7/VPC-G12-12  
 with ATS MA12/S-7/HF and  
 absorber HF-A-2,4GHz-ATSMA12

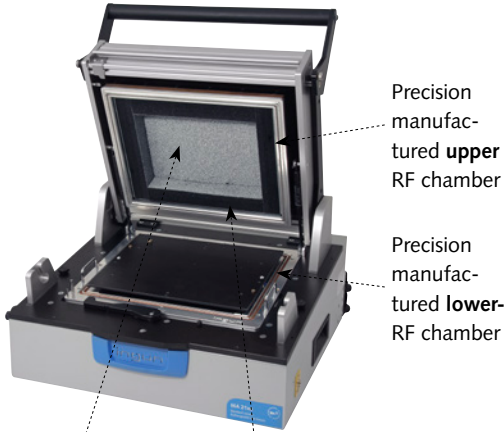

conductive surface (light grey)  
 non-conductive surface (anthracite)

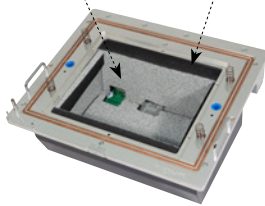

Precision manufactured  
**lower** RF chamber  
 with absorbers  
 HF A-2.4GHz-ATSMA12

**RF Absorber (HF-A)**

RF absorbers are needed to build an internal radio network. They are used to clad the interior walls of the ATS MAxx/HF high frequency exchangeable kits to prevent unwanted reflections of radio signals within the RF chamber.

The absorber sets used for this purpose are chosen depending on the frequency being used and the size of the exchangeable kit. When customising the exchangeable kits with absorbers, the original useable area and the maximal possible component height on the RF board are reduced. In this case, additional customisation of the RF exchangeable kits for RF boards with higher components is generally possible.

Delivery includes absorber mats, mounting plates, and screws.

**Assembly**

Absorber mats have a conductive (light grey) and a non-conductive (anthracite) surface. When mounting, please ensure that the light grey side is aligned with the RF board and the anthracite side is aligned with the copper cover.

INGUN provides customising documents for customisation. The RF absorbers are to be mounted according to customising guidelines **info 1925**.

Radio frequency exchangeable kit  
 ATS MAxx/HF

**Ordering information**

RF Absorber (HF-A)		HF-A-x,xGHz-ATSMA11	HF A-x,xGHz-ATSMA12	HF A-x,xGHz-ATSMA13
Compatible with:		ATS MA11(/S-5)/HF Part no. 54011   54111	ATS MA12(/S-7)/HF Part no. 54012   54112	ATS MA13(/S-10)/HF Part no. 54013   54113
from 2.4 GHz	Part no.:	<b>51373</b>	<b>51436</b>	<b>51447</b>
	Usable area (W x D):	77 x 130 mm	212 x 137 mm	349 x 212 mm
	Max. component height:	35 mm	35 mm	35 mm
from 3.5 GHz	Part no.:	<b>51374</b>	<b>51437</b>	<b>51448</b>
	Usable area (W x D):	97 x 141 mm	218 x 157 mm	374 x 233 mm
	Max. component height:	45 mm	45 mm	45 mm
from 7.5 GHz	Part no.:	<b>51376</b>	<b>51438</b>	<b>51449</b>
	Usable area (W x D):	97 x 158 mm	218 x 175 mm	374 x 240 mm
	Max. component height:	54 mm	54 mm	54 mm

# Function units (FB)







## Customised increase in functionality

With **functional units** (FB) the manual test fixture **MA xxxx** and the exchangeable kits **ATS MAxx** can be expanded as required. For example, the **ease of use** and the **testing reliability increased** or the **handling times are reduced**.

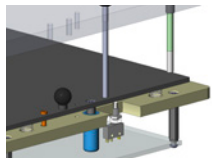
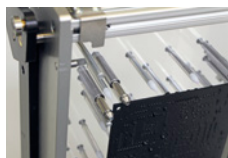
Functional units are available in numerous designs and fulfil a wide variety of tasks that make testing electronic functional units simpler, more comfortable and safer.



MA 2112/D/H/S-7/Pylon with various functional units

Examples
 <p>Detection checks</p>
 <p>Lifting units</p>
 <p>Open stop limit</p>
 <p>Self-opening unit</p>
 <p>Safety switch</p>
 <p>Control box</p>
 <p>Locks</p>

**Usage**

Functional units (FB) are used to expand the functionality of manual test fixture MA xxxx and the exchangeable kits ATS MAxx as required.

The different versions are used for the following tasks:

- **Detection checks (FB-ABF-...)**  
To manage essential control tasks (e.g. test start) .
- **Lifting units (FB-AHE-...)**  
In order to automatically remove tested specimens from the probe field to lift them upwards safely when opening the pressure frame unit.
- **Open stop limit (FB-OBR-...)**  
To limit the pressure frame unit to an opening angle of 45°.
- **Self-opening unit (FB-SOP/SOE-...)**  
To automatically and independently open the manual test fixture.
- **Safety switch (FB-SIS-...)**  
For safety-related locking of the closed pressure frame unit, mainly for tests in the low voltage range.
- **Control box (FB-STE-...)**  
To easily and reliably control the functional units available for the manual test fixtures.
- **Locks (FB-VER-...)**  
To lock the pressure frame unit for tests that must not be interrupted or when the pressure frame unit may only be closed under certain conditions.

**Compatibility**

Functional units cannot be used in any combination. Depending on the version, functional units can only be mounted by INGUN or subsequently by the customers themselves, either with or without additional machining. Compare options using the compatibility matrix on page 76 to 77, which describes possible combinations and shows the type of assembly in colour (●●●●).

**FB - MA xxxx / ATS MAxx**

<b>FB-...-MA</b>	
FB-SLV-MA	68
FB-ESD-MA	68
FB-ESD-S-MA	68
FB-2VE-MA	68
FB-2VP-MA	68
FB-2VM-MA	69
FB-SIS-ZSO-MA	69
FB-SIS-ZSG-MA	69
FB-SIS-MA	69
FB-SIS-BM-MA	69
FB-SOP-MA	70
FB-SOE-MA	70
FB-ABF-G-S-MA	70
FB-ABF-K-I-MA	70
FB-ABF-V-I-MA	70
FB-ABF-V-SKS-MA	71
FB-VER-G-ESG-MA	71
FB-VER-G-ESO-MA	71
FB-VER-G-P-MA	71
FB-VER-O-ESO-MA	71
FB-OBR-MA	71
FB-GDF-400N-MA	72
FB-MGK-MA	72
FB-LED-MA	72
FB-ADT-MA	72
FB-OLB-MA	72
FB-ADT-MA	72
FB-VLK-MA	73
FB-STE-UNI-MA	73
FB-STE-MAG-MA	73
<b>FB-...-ATS</b>	
FB-2SN-ATS	73
FB-VSL-NDH-ATS	73
FB-VSL-KTE-ATS	73
FB-ELS-22-ATS	74
FB-BSP-ATS	74
FB-AHE-ATS	74
FB-ABF-G-GKS-ATS	74
FB-ABF-K-S-ATS	74
FB-BTV-ATS	74
FB-BT2-ATS	75
FB-BTM-ATS	75
MAP ATSMa	75
FB-ZSK-ATS	75
FB-ZSK-ESD-ATS	75



# Functional units (FB) Assembly

Assembly drawings illustrating the installation and any necessary processing steps are provided for the assembly of the functional units. Below you will find a selection of functional units for mounting on the MA xxxx basic unit and the replacement set ATS MAxx.

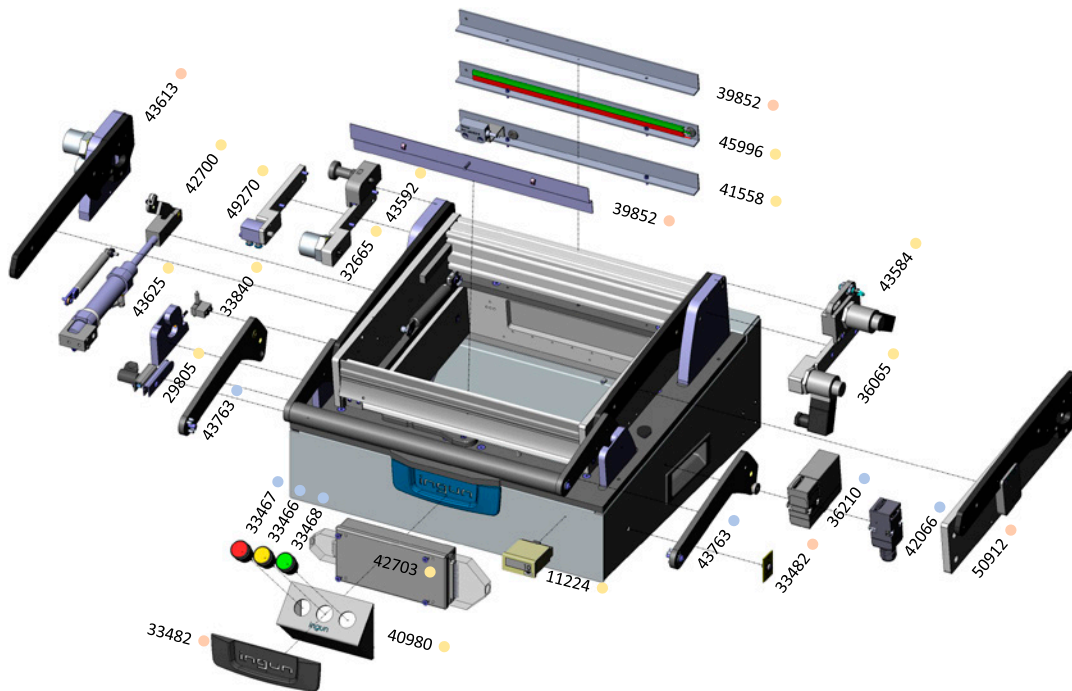

Functional units for the basic unit using MA 2112/D/H/S-7 as an example

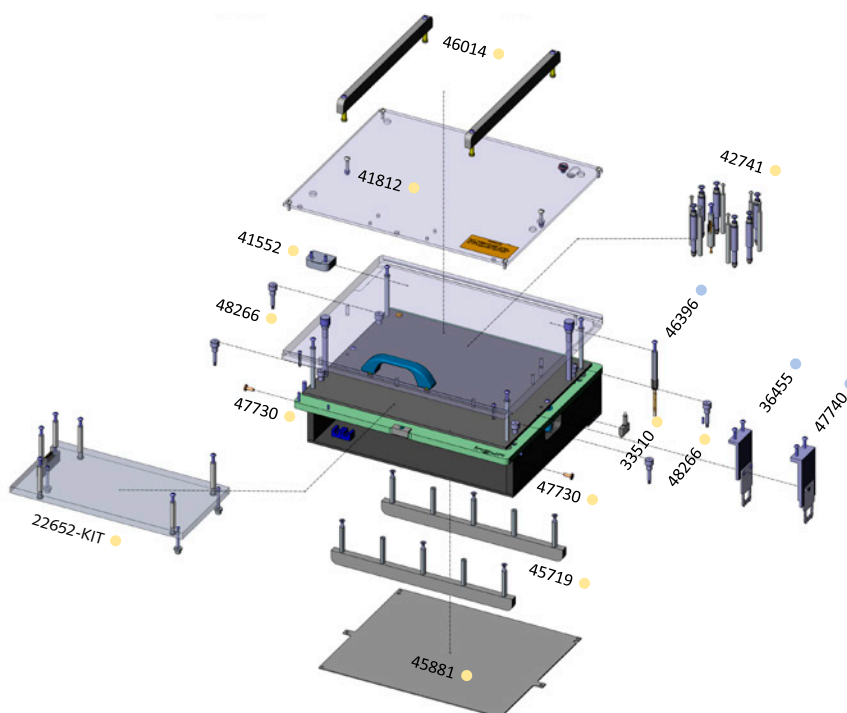

Functional units for the replacement set using ATS MA12/S-7 as example

# Functional units (FB)

## Operating convenience, handling times and testing reliability

### INCREASED OPERATING COMFORT

Example of use for **increased ease of use:**

LED lighting (1) | Self-opening unit (2) | Extended latch (3) | Mounting pushbutton (4) | Pushbutton (5)

Basic unit MA xxxx



+

Exchangeable kit ATS MAxx

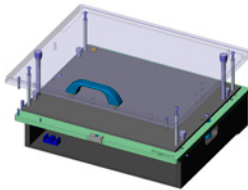

=

Manual test fixture MA xxxx with ATS MAxx



### REDUCED HANDLING TIMES

Example of use for **reduction of handling time:**

Open limit (1) | Lifting unit (2)

Basic unit MA xxxx



+

Exchangeable kit ATS MAxx

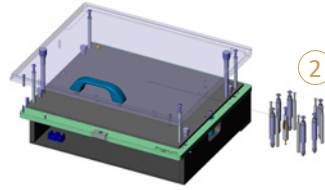

=

Manual test fixture MA xxxx with ATS MAxx

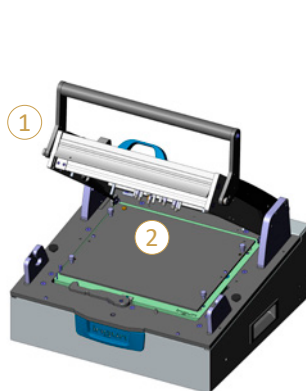

### INCREASED TESTING RELIABILITY

Example of use for **increased test safety use:**

Checks (1) | Locks (2) | Safety switch (3)

Basic unit MA xxxx

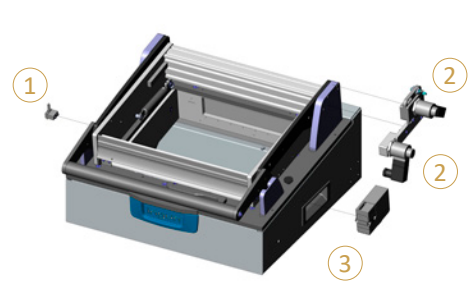

+

Exchangeable kit ATS MAxx

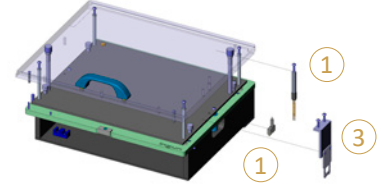

=

Manual test fixture MA xxxx with ATS MAxx

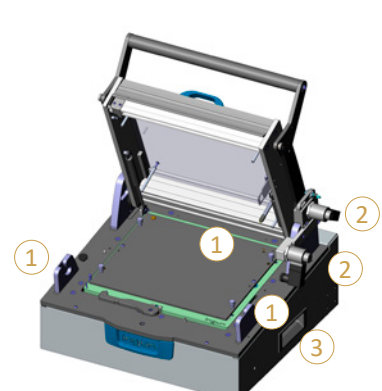

### FB-SLV-MA: Protective conductor wiring and contact protection for dangerous voltages (LVD customisation)

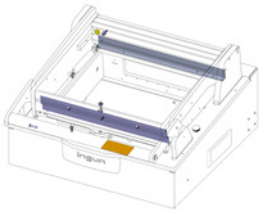

In the case of LVD customisation, the test fixture is equipped with a protective conductor wiring (yellow/green cable) and contact protection, and a measurement of the protective conductor resistance is carried out (limit value 0.3 Ω). This is necessary for tests with dangerous voltage (> 25 V AC and > 60 V DC) and to fulfil protection class IP3x according to DIN EN 60529.

MA 2x09	MA xx11	MA xx12	MA xx13	MA xx13T	MA xx14	Assembly
<b>40509</b>	<b>39851</b>	<b>39852</b>	<b>39853</b>	<b>39855</b>	<b>39854</b>	●

### FB-ESD-MA: ESD customisation



For ESD customisation, the test fixture is provided with ESD wiring (black cables) with earth connection and a connection for an ESD anti-static tape.

MA 2x09	MA xx11	MA xx12	MA xx13	MA xx13T	MA xx14	Assembly
<b>33482</b>				<b>33482 (2x)</b>	<b>33482</b>	●

### FB-ESD-S-MA: ESD customisation with protective conductor wiring

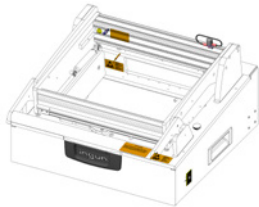

For ESD customisation for LVD-equipped test fixtures, the test fixture is equipped with ESD wiring (black cable) with earth connection and a connection for an ESD anti-static tape. The article number should only be used in conjunction with the article number of the LVD customisation.

MA 2x09	MA xx11	MA xx12	MA xx13	MA xx13T	MA xx14	Assembly
<b>43597</b>				<b>43597 (2x)</b>	<b>43597</b>	●

### FB-2VE-MA: Dual-stage contact - electrically locked



For carrying out the combined ICT/FCT dual-stage contacting. The first stage for the ICT is achieved as soon as the pressure frame unit is completely closed. The second stage for the FCT, which is about 5 mm above the first stage, is achieved by lifting the handle. The limitation of both contacting stages is realised electrically.

MA 2x09	MA 2x11	MA 2x12	MA 2x13	MA 2x13T	MA 2x14	Assembly
	<b>60859</b> (mounted - left)		<b>59508</b> (mounted - left)	-	<b>59508</b> (mounted - left)	●
	<b>60856</b> (mounted - right)		<b>102597</b> (mounted - right)	-	<b>102597</b> (mounted - right)	

Please refer to our technical handbook for the MA xxxx series and our dual-stage MA function matrix (info 2069) when using the electric self-opener (part 45220) in combination with other functional units.

### FB-2VP-MA: Dual-stage contacting - pneumatically locked

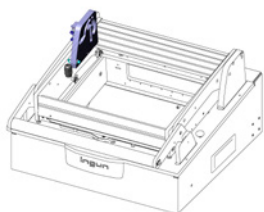

For carrying out the combined ICT/FCT dual-stage contacting. The first stage for the ICT is achieved as soon as the pressure frame unit is completely closed. The second stage for the FCT, which is about 5 mm above the first stage, is achieved by lifting the handle. The limitation of both contacting stages is realised pneumatically.

MA 2x09	MA 2x11	MA 2x12	MA 2x13	MA 2x13T (*)	MA 2x14	Assembly
<b>59555</b> (mounted - left)		<b>59507</b> (mounted - left)		<b>59507</b> (mounted - left) <b>100700</b> (mounted - right)	<b>59507</b> (mounted - left)	●

\*: Part 59507 is mounted on the left side of the left drive unit (ATE); part 100700 is mounted on the right side of the right drive unit (ATE).

Please refer to our technical handbook for the MA xxxx series and our dual-stage MA function matrix (info 2069) when using the pneumatic self-openers (parts 42701 & 42700) in combination with other functional units.

**FB-2VM-MA: Dual-stage contacting - mechanically locked**



For carrying out the combined ICT/FCT dual-stage contacting. The first stage for the ICT is achieved as soon as the pressure frame is completely closed. The second stage for the FCT, which is about 5 mm above the first stage, is achieved by lifting the handle. The limitation of both contacting stages is realised mechanically.

MA 2x09	MA 2x11	MA 2x12	MA 2x13	MA 2x13T	MA 2x14	Assembly
50914	50912		50913	50912 (2x)	50913	●

**FB-SIS-ZSO-MA: Safety switch with solenoid interlock NO (currentless, open)**

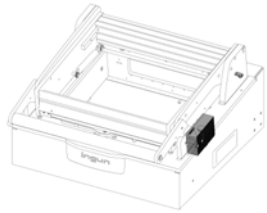

For safety-relevant locking of the closed pressure frame unit, in particular for tests with dangerous voltage (> 25 V AC and > 60 V DC). The safety switch is designed with a solenoid interlock that is normally open (NO - normally open). The test fixture can be opened in case of power failure.

MA 2x09	MA xx11	MA xx12	MA xx13	MA xx13T	MA xx14	Assembly
36210				36210 (2x)	36210	●

**FB-SIS-ZSG-MA: Safety switch with solenoid interlock NC (normally closed)**

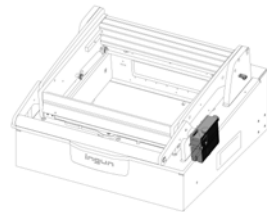

For safety-relevant locking of the closed pressure frame unit, in particular for tests with dangerous voltage (> 25 V AC and > 60 V DC). The safety switch is designed with a solenoid interlock that is normally closed (NC - normally closed). The test fixture cannot be opened in case of power failure.

MA 2x09	MA xx11	MA xx12	MA xx13	MA xx13T	MA xx14	Assembly
46020				46020 (2x)	46020	●

**FB-SIS-MA: Safety switch without solenoid interlock**



For safety-relevant locking of the closed pressure frame unit, in particular for tests with dangerous voltage (> 25 V AC and > 60 V DC). The safety switch is designed without solenoid interlock.

MA 2x09	MA xx11	MA xx12	MA xx13	MA xx13T	MA xx14	Assembly
42066				42066 (2x)	42066	●

**FB-SIS-BM-MA: Magnetic safety switch**

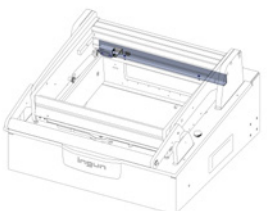

For safety-relevant locking of the closed pressure frame unit, in particular for tests with dangerous voltage (> 25 V AC and > 60 V DC). The safety switch is magnetic.

MA 2x09	MA xx11	MA xx12	MA xx13	MA xx13T	MA xx14	Assembly
41560		41558	41556	41560 (2x)	41553	●

### FB-SOP-MA: Pneumatic self-opening unit

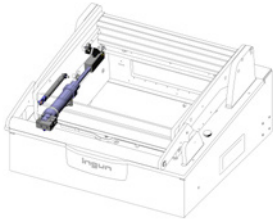

Self-openers are used to automatically open manual test fixtures independently. A hydraulic brake cylinder serves to reduce the opening speed, especially useful for fixtures customised with high contact forces (this brake cylinder is not included in the delivery of the MA 2109). The self-opening mechanism is operated pneumatically.

MA 2x09	MA xx11	MA xx12	MA xx13	MA xx13T	MA xx14	Assembly
42701	42700			42700 (2x)	42700	●

### FB-SOE-MA: Electric self-opening unit

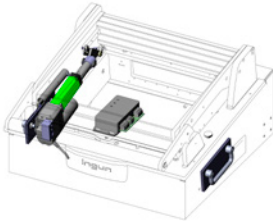

Self-openers are used to automatically open manual test fixtures independently. A hydraulic brake cylinder serves to reduce the opening speed, especially useful for fixtures customised with high contact forces. The self-opening mechanism is operated electrically.

MA 2x09	MA xx11	MA xx12	MA xx13	MA xx13T	MA xx14	Assembly
-	45220			45220 (2x)	45220	●

### FB-ABF-G-S-MA: Closed pressure frame unit check with stroke switch

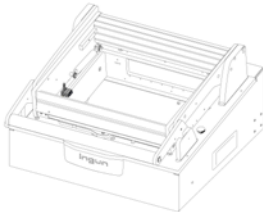

Detection checks are used to manage essential control tasks (e.g. test start). The check for the closed pressure frame unit is realised with a stroke switch. The detection is not suitable for combined ICT/FCT dual-stage operation.

MA 2x09	MA xx11	MA xx12	MA xx13	MA xx13T	MA xx14	Assembly
33840				33840 (2x)	33840	●

### FB-ABF-K-I-MA: Closed pressure frame unit check with inductive sensor

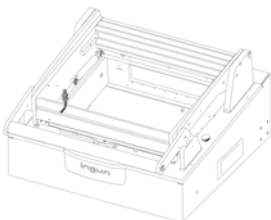

Detection checks are used to manage essential control tasks (e.g. test start). The detection of the closed pressure frame unit is realised with an inductive sensor. The detection is not suitable for combined ICT/FCT dual-stage operation.

MA 2x09	MA xx11	MA xx12	MA xx13	MA xx13T	MA xx14	Assembly
37550				37550 (2x)	37550	●

### FB-ABF-V-I-MA: Locking position pressure frame unit check with inductive sensor

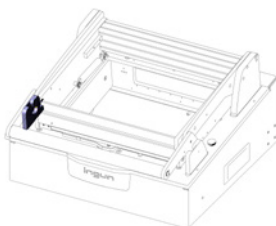

Detection checks are used to manage essential control tasks (e.g. test start). The detection of the locking position of the closed pressure frame unit is realised with an inductive sensor. The detection is not suitable for combined ICT/FCT dual-stage operation.

MA 2x09	MA 2x11	MA 2x12	MA 2x13	MA 2x13T	MA 2x14	Assembly
43625				43625 (2x)	43625	●
-	MA 3211	MA 3212	MA 3213	MA 3213T	MA 3214	Assembly
-	46745			46745 (2x)	46745	●



**FB-ABF-V-SKS-MA: Locked exchangeable kit check with switching probe**

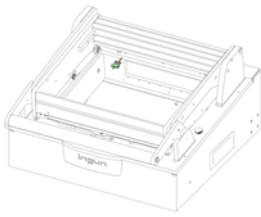

Detection checks are used to manage essential control tasks (e.g. test start). The detection of the locked exchangeable kit is realised with a switching probe.

MA 2x09	MA xx11	MA xx12	MA xx13	MA xx13T	MA xx14	Assembly
43246				43246 (2x)	43246	●

**FB-VER-G-ESG-MA: Locking of closed pressure frame unit with stroke magnet NC (normally closed)**

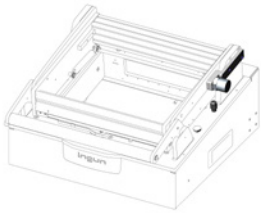

For locking the pressure frame unit when tests must not be interrupted or when the dangerous voltage could prevail even after the test. The locking mechanism is normally closed (NC - normally closed). The test fixture cannot be opened in case of power failure.

MA 2x09	MA xx11	MA xx12	MA xx13	MA xx13T	MA xx14	Assembly
32665				32665 (2x)	32665	●

**FB-VER-G-ESO-MA: Locking of closed pressure frame unit with stroke magnet NO (normally open)**



For locking the closed pressure frame unit when tests must not be interrupted or when the dangerous voltage could prevail even after the test. The locking mechanism is normally open (NO - normally open). The test fixture can be opened in case of power failure.

MA 2x09	MA xx11	MA xx12	MA xx13	MA xx13T	MA xx14	Assembly
36065				36065 (2x)	36065	●

**FB-VER-G-P-MA: Locking of closed pressure frame unit with pneumatic short-stroke cylinder**

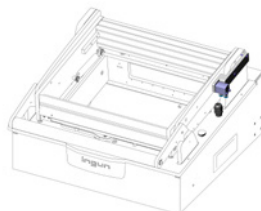

For locking the closed pressure frame unit when tests must not be interrupted or when the dangerous voltage could prevail even after the test. The locking is pneumatic.

MA 2x09	MA xx11	MA xx12	MA xx13	MA xx13T	MA xx14	Assembly
49270				49270 (2x)	49270	●

**FB-VER-O-ESO-MA: Locking of open pressure frame unit with stroke magnet NO (normally open)**



For locking the open pressure frame unit, if closing of the pressure frame unit is only allowed under certain conditions. The locking mechanism is normally open (NO - normally open). The test fixture can be closed in case of power failure.

MA 2x09	MA xx11	MA xx12	MA xx13	MA xx13T	MA xx14	Assembly
43584				43584 (2x)	43584	●

**FB-OBR-MA: Open pressure frame unit stop limit**

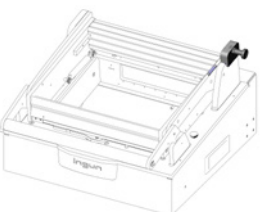

To limit the opening of pressure frame unit to an opening angle of 45°. The open stop limit is activated by a locking pin.

MA 2x09	MA xx11	MA xx12	MA xx13	MA xx13T	MA xx14	Assembly
43592				43592 (2x)	43592	●

### FB-GDF-400N-MA: Gas pressure spring for drive unit



Kit consisting of gas pressure springs and mounting material for replacing the pre-assembled telescopic cover stay. The force of the opening of the housing is reduced by the gas pressure springs.

MA 2x09	MA xx11	MA xx12	MA xx13	MA xx13T	MA xx14	Assembly
-	48730				-	●

### FB-MGK-MA: Metal handle, hinged



Hinged metal handle for replacing handles on particularly heavy test adapters, or for ESD-customised fixtures.

MA 2x09	MA xx11	MA xx12	MA xx13	MA xx13T	MA xx14	Assembly
47715						●

### FB-LED-MA: Pass/fail LED indication

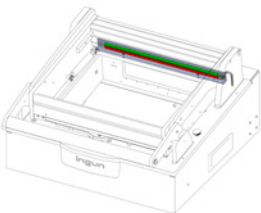

For signalling the test results on the test fixture, by clearly visible illumination of the test fixture interior.

MA 2x09	MA xx11	MA xx12	MA xx13	MA xx13T	MA xx14	Assembly
45770		45996	45999	45770 (2x)	46000	●

### FB-ADT-MA: Box for push button

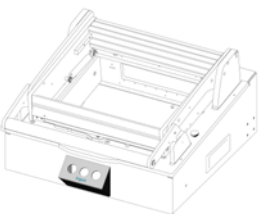

For assembly of individual function push buttons: yellow (part no: 33466), red (part no: 33467), green (part no. 33468) or blind caps (part no. 48687).

MA 2x09	MA xx11	MA xx12	MA xx13	MA xx13T	MA xx14	Assembly
40980						●

### FB-OLB-MA: Oil brake



After releasing the locking mechanism, movement of the handle is accelerated by high forces, which are caused by a large number of installed test probes. The oil brake provides shock absorption for the entire locking mechanism, thus improving handling. The oil brake achieves a typical life span of approximately 200,000 load cycles.

MA 2x09	MA xx11	MA xx12	MA xx13	MA xx13T	MA xx14	Assembly
-	51770			51770 (2x)	51770	●

### FB-KSG-MA: Anti-pinch protection

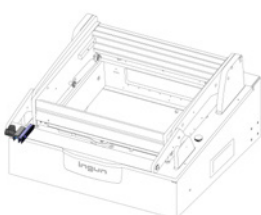

The anti-pinch protection creates a safe distance between the housing and drive unit so that operators' fingers are protected, even if the unit accidentally closes. To fully close the drive unit, the anti-pinch protection must be folded backwards using the lever.

MA 2x09	MA xx11	MA xx12	MA xx13	MA xx13T	MA xx14	Assembly
29805		Available as standard				●

**FB-VLK-MA: Extended latch**

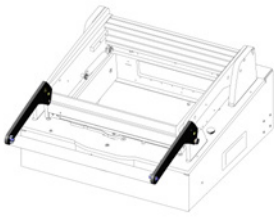

When using the extended latch, the clamping force is reduced by a third of the pressure force when the fixture is fully loaded with 2,000 N. For test fixtures MA 2xxx from 120 N to 80 N and for test fixtures MA 3xxx from 70 N to 47 N.

MA 2x09	MA 2x11	MA 2x12	MA 2x13	MA 2x13T	MA 2x14	Assembly
43763				43763 (2x)	43763	●
-	MA 3211	MA 3212	MA 3213	MA 3213T	MA 3214	Assembly
-	44831			44831 (2x)	44831	●

**FB-STE-UNI-MA: MA control box**



To control the functional units available for the manual test fixtures easily and reliably. The MA control box has several galvanically isolated, polarity-independent, potential-free and reverse-polarity protected wide-range inputs from 5 to 24 volts, for processing the pass/fail signals coming from the test system.

MA 2x09	MA xx11	MA xx12	MA xx13	MA xx13T	MA xx14	Assembly
42703						●

**FB-STE-MAG-MA: Magnetic control**



To significantly reduce the heat loss on locking magnets. This is achieved by switching on at full voltage (24 volts). After 1 second, the solenoid control reduces the power to a quarter; this is enough to hold the lift bar.

MA 2x09	MA xx11	MA xx12	MA xx13	MA xx13T	MA xx14	Assembly
42810						●

**FB-2SN-ATS: Dual-Stage retrofit kit**



For the use of the ATS in a dual-stage test fixture, an upgrade kit with replacement parts is provided. With this upgrade kit, the PCB support plate is brought to a higher level, so that the longer FCT test probes do not protrude and are not damaged when inserting the DUT.

ATS MA09	ATS MA11	ATS MA12	ATS MA13	ATS MA14	Assembly
48266					●

**FB-VSL-NDH-ATS: Stiffener bars for pressure frame unit plate**

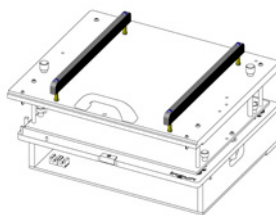

For installations with more than 300 test probes or a force greater than 500 N, we recommend the use of reinforcement strips to prevent bending of the pressure frame unit plate (NHP). Delivery includes a bar with mounting hardware.

ATS MA09	ATS MA11	ATS MA12	ATS MA13	ATS MA14	Assembly
-	46014		46013		●

**FB-VSL-KTE-ATS: Stiffener bars for probe plate**

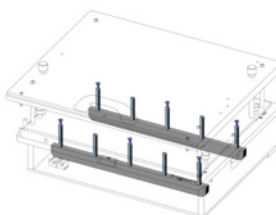

For customisation with more than 300 test probes or a force greater than 500 N, we recommend the use of reinforcement strips to prevent bending of the probe plate (KTP). Delivery includes a bar with mounting hardware.

ATS MA09	ATS MA11	ATS MA12	ATS MA13	ATS MA14	Assembly
-	-	45719	46861	46863	●

### FB-ELS-22-ATS: Insertion blocker for stroke 22

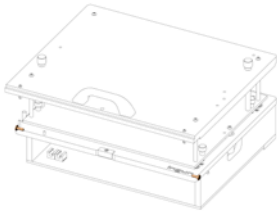

For exchangeable kits especially designed for use in MA 3xxx test fixtures with are customised with a 22 mm parallel stroke.

ATS MA09	ATS MA11	ATS MA12	ATS MA13	ATS MA14	Assembly
<b>47730</b>					●

### FB-BSP-ATS: Protective cover for dangerous voltages



For tests with dangerous voltage (> 25 V AC and > 60 V DC), the exchangeable kit must be equipped with shock-proof protective cover and a IP3x degree of protection in accordance with DIN EN 60529 must be fulfilled. Delivery includes the protection plate and LVD customisation compliant stacking screws (part no. 52394).

ATS MA09	ATS MA11	ATS MA12	ATS MA13	ATS MA14	Assembly
<b>41809</b>	<b>41811</b>	<b>41812</b>	<b>41813</b>	<b>41814</b>	●

### FB-AHE-ATS: Lifting units



Lifting units are used to automatically remove tested specimens from the probe field when opening the pressure frame unit and to lift them up securely. The position of the DUT is fixed by means of limiting pins. The DUT itself is picked up by quick-release bending pins.

ATS MA09	ATS MA11	ATS MA12	ATS MA13	ATS MA14	Assembly
<b>Single-stage version: 42741 / 42731 (individual bending pin) Dual-stage version: 42742 / 42732 (individual bending pin)</b>					●

### FB-ABF-G-GKS-ATS: Closed pressure frame unit check with two test probes (GKS)

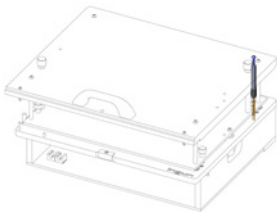

Detection checks are used to manage essential control tasks (e.g. test start). The detection of the closed pressure frame unit is realised with two spring-loaded test probes. The detection is not suitable for combined ICT/FCT dual-stage operation.

ATS MA09	ATS MA11	ATS MA12	ATS MA13	ATS MA14	Assembly
<b>46396</b>					●

### FB-ABF-K-S-ATS: Closed pressure frame unit check with stroke switch

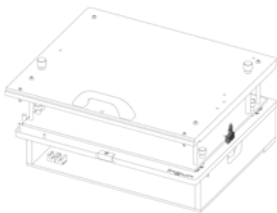

Detection checks are used to manage essential control tasks (e.g. test start). The detection of the closed pressure frame unit is realised with a stroke switch. The detection is not suitable for combined ICT/FCT dual-stage operation.

ATS MA09	ATS MA11	ATS MA12	ATS MA13	ATS MA14	Assembly
<b>33510</b>					●

### FB-BTV-ATS: Actuator for safety switch with single-stage contacting

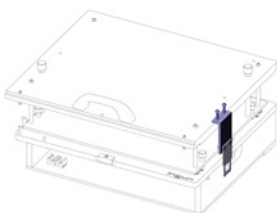

Actuators are used to reliably operate safety switches with and without solenoid interlock. The actuator is designed for the safety switches (FB-SIS-ZSO-MA, FB-SIS-ZSG-MA and FB-SIS-MA) and for use with exchangeable kits with single-stage contacting..

ATS MA09	ATS MA11	ATS MA12	ATS MA13	ATS MA14	Assembly
<b>100414</b>	<b>36455</b>				●

**FB-BT2-ATS: Actuator for safety switch with dual-stage contacting**

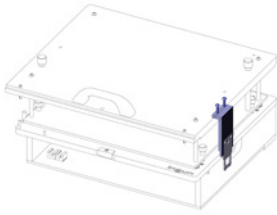

Actuators are used to reliably operate safety switches with and without solenoid interlock. The actuator is designed for the safety switches (FB-SIS-ZSO-MA, FB-SIS-ZSG-MA, and FB-SIS-MA) and for use with exchangeable kits with dual-stage contacting.

ATS MA09	ATS MA11	ATS MA12	ATS MA13	ATS MA14	Assembly
103273	47740				●

**FB-BTM-ATS: Actuator for magnetic safety switch with single-stage contacting**



Actuators are used to reliably operate safety switches with and without solenoid interlock. The actuator is designed for the magnetic safety switch (FB-SIS-BM-MA) and for use with exchangeable kits with single-stage contacting.

ATS MA09	ATS MA11	ATS MA12	ATS MA13	ATS MA14	Assembly
41552					●

**MAP ATSMa: Ground plates for exchangeable kits**

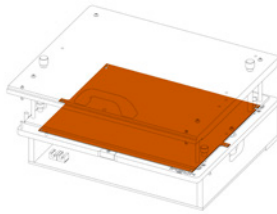

Ground plates are commonly used to wire the shielding (ground) to an additional plate using twisted pair wiring or coaxial cables. All GKS in the ground plate have to be spot-faced.

ATS MA09	ATS MA11	ATS MA12	ATS MA13	ATS MA14	Assembly
45873	45874	45881	45882	45883	●

**FB-ZSK-ATS: Contacting from top side for standard exchangeable kits (mounting kit)**

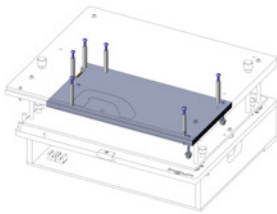

Mounting kits for top side contacting are used as soon as double-sided contact is made in the exchangeable kit. Delivery of the mounting kit for standard exchangeable kits includes six hex bolts, four collar screws, three headed drill bushings, two distance rollers with screws and pins (without acrylic sheet and transfer panel). Transfer panels can be found on page 196.

ATS MA09	ATS MA11	ATS MA12	ATS MA13	ATS MA14	Assembly
22652-KIT					●

**FB-ZSK-ESD-ATS: Contacting from top side for ESD exchangeable kits (mounting kit)**

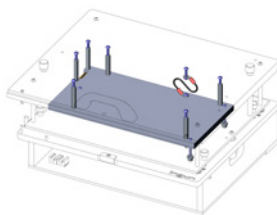

Mounting kits for top side contacting are used as soon as double-sided contacting is carried out in the exchangeable kit. Delivery of the mounting kit for ESD exchangeable kits includes discharge cables, six hexagon bolts, four collar screws, three headed drill bushings, two distance rollers with screws and pins (without acrylic glass plate and transfer panel). Transfer panels can be found on page 196.

ATS MA09	ATS MA11	ATS MA12	ATS MA13	ATS MA14	Assembly
45704-KIT					●

For information about how to mount the functional units correctly, please refer to the corresponding installation instructions, which describe the installation and any essential rework steps.

For information about proper installation of the functional units, please refer to the Technical Handbook for Manual Test Fixtures MA xxxx with ATS MAxx, which can be downloaded from our website [www.ingun.com](http://www.ingun.com).









# Functional unit (FB) Compatibility matrix

Item No.	Catalogue page	Description of functional unit	Short designation	Part number	Protection conductor wiring and contact protection for d					
					68	68	68	68	68	69
<b>Key:</b> ok Application possible NO Application not possible XX Application not recommended rec. Application recommended incl. Component included in option ess. Essential option  <b>Designation re: assembly of functional unit</b> Subsequent assembly possible without rework possible Subsequent assembly possible with rework Assembly only possible at INGUN					1	2	3	4	5	6
					MA Protection conductor wiring and contact protection for dangerous	MA ESD assembly	MA ESD assembly and protection conductor wiring	MA Dual-stage - electric locking	MA Dual-stage - pneumatic locking	MA Dual-stage - pneumatic locking
					68	68	68	68	68	69
1	68	MA Protection conductor wiring and contact protection for dangerous	FB-SLV-MA	40509, 39851, 39852, 39853, 39855, 39854	ok	NO	ok	ok	ok	ok
2	68	MA ESD assembly	FB-ESD-MA	33482	NO	XX	NO	ok	ok	ok
3	68	MA ESD assembly and protection conductor wiring	FB-ESD-S-MA	43597	ok	NO	ok	ok	ok	ok
4	68	MA Dual-stage - electric locking	FB-2VE-MA	60859, 59508, 100696, (60856)	ok	ok	ok	XX	NO	NO
5	68	MA Dual-stage - pneumatic locking	FB-2VP-MA	59555, 59507, 100700	ok	ok	ok	NO	XX	NO
6	69	Mechanical stroke limitation	FB-2VM-MA	50914, 50912, 50913	ok	ok	ok	NO	NO	XX
7	36 ff.	ATS ESD version	ATS MAxx ..JESD	5026, 46248, 46236, 46250, 46239, 46254, 46242	ok	ess.	ess.	ok	ok	ok
8	37 ff.	ATS Radio frequency version	ATS MAxx ..JHF	54011, 54111, 54012, 54112, 54013, 54113	NO	ok	NO	NO	NO	NO
9	69	MA Safety switch with locking NO (currentless; open)	FB-SIS-ZSO-MA	36210	ok	ok	ok	ok	ok	ok
10	69	MA Safety switch with locking mechanism NC (currentless; closed)	FB-SIS-ZSG-MA	46020	ok	ok	ok	ok	ok	ok
11	69	MA Safety switch without locking	FB-SIS-MA	42066	ok	ok	ok	ok	ok	ok
12	69	MA Magnetic safety switch	FB-SIS-BM-MA	41560, 41558, 41556, 41553	ok	ok	ok	NO	NO	NO
13	70	MA Self-opener pneumatic	FB-SOP-MA	42701, 42700	ok	ok	ok	NO	NO	NO
14	70	MA Self-opener electric	FB-SOE-MA	45220	ok	ok	ok	NO	NO	NO
15	70	MA Check for closed pressure frame via stroke switch	FB-ABF-G-S-MA	33840	ok	ok	ok	ok	ok	ok
16	70	MA Check for closed pressure frame stroke position by inductive sensor	FB-ABF-K-I-MA	37550	ok	ok	ok	ok	ok	ok
17	70	MA Check for closed pressure frame position by inductive sensor	FB-ABF-V-I-MA	43625, 46745	ok	ok	ok	ok	ok	ok
18	71	MA Check ATS locked	FB-ABF-V-SKS-MA	43246	ok	ok	ok	ok	ok	ok
19	71	MA Locking unit for closed NDH stroke magnet NC (currentless; closed)	FB-VER-G-ESG-MA	32665	ok	ok	ok	NO	NO	NO
20	71	MA Locking unit for closed NDH stroke magnet NO (currentless; open)	FB-VER-G-ESO-MA	36065	ok	ok	ok	NO	NO	NO
21	71	MA Locking unit for closed pressure frame pneumatic cylinder locking	FB-VER-G-P-MA	49270	ok	ok	ok	NO	NO	NO
22	71	MA Locking unit for open pressure frame	FB-VER-O-ESO-MA	43584	ok	ok	ok	ok	ok	ok
23	71	MA Pressure frame unit opening limited	FB-OBR-MA	43592	ok	ok	ok	ok	ok	ok
24	72	MA Gas pressure springs for the drive unit (kit)	FB-GDF-400N-MA	48730	ok	ok	ok	ok	ok	ok
25	72	MA Hinged metal handle	FB-MGK-MA	47715	ok	rec.	ok	ok	ok	ok
26	72	MA Pass / fail LED indicator	FB-LED-MA	45770, 45996, 45999, 46000	ok	ok	ok	ok	ok	ok
27	72	MA Push button	FB-ADT-MA	40980	ok	ok	ok	ok	ok	ok
28	72	MA Oil break	FB-OLB-MA	51770	ok	ok	ok	rec.	rec.	rec.
29	72	MA Anti-pinch protection	FB-KSG-MA	29805	ok	ok	ok	ok	ok	ok
30	73	MA Extended handle	FB-VLK-MA	43763, 44831	ok	ok	ok	ok	ok	ok
31	73	MA Control unit	FB-STE-UNI-MA	42703	ok	ok	ok	NO	rec.	ok
32	73	MA Magnet control unit	FB-STE-MAG-MA	42810	ok	ok	ok	rec.	XX	XX
33	73	ATS Dual-stage upgrade kit (for contacting from bottom side)	FB-2SN-ATS	48266	ok	ok	ok	ok	ok	rec.
34	73	ATS Stiffener kit for NDH	FB-VSL-NDH-ATS	46014, 46013	ok	ok	ok	ok	ok	ok
35	73	ATS Stiffener kit for KTE	FB-VSL-KTE-ATS	45719, 46861, 46863	ok	ok	ok	ok	ok	ok
36	74	ATS Insertion blocker for 22mm stroke	FB-ELS-22-ATS	47730	ok	ok	ok	ok	ok	ok
37	74	ATS Contact protection for dangerous voltage	FB-BSP-ATS	41809, 41811, 41812, 41813, 41814	ess.	ok	ess.	ok	ok	ok
38	74	ATS Lifting units	FB-AHE-ATS	42741, (42731)	ok	ok	ok	ok	NO	NO
39	74	ATS Check for closed pressure frame using two GKS	FB-ABF-G-GKS-ATS	46396	ok	ok	ok	NO	NO	NO
40	74	ATS Check for closed pressure frame via stroke switch	FB-ABF-K-S-ATS	33510	ok	ok	ok	NO	NO	NO
41	74	ATS Actuator for single-stage	FB-BTV-ATS	100414, 36455	ok	ok	ok	ok	NO	NO
42	75	ATS Actuator for dual-stage (basic unit)	FB-BT2-ATS	103272, 47740	ok	ok	ok	ok	ok	ok
43	75	ATS Actuator for magnetic safety switch	FB-BTM-ATS	41552	ok	ok	ok	NO	NO	NO
44	75	ATS Earthing plate for ATS	MAP ATSMAXx	45873, 45874, 45881, 45882, 45883	ok	ok	ok	ok	ok	ok
45	75	ATS assembly kit, normal assembly, contacting from top side	FB-ZSK-ATS	22652	ok	ok	NO	NO	NO	NO
46	75	ATS assembly kit, ESD assembly, contacting from top side	FB-ZSK-ESD-ATS	45704	ok	ess.	ess.	NO	NO	NO

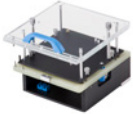
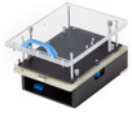
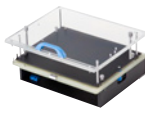
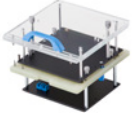
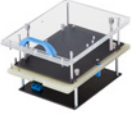
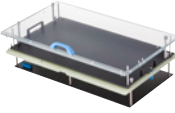

# Overview

## Exchangeable kits ATS MAxx

Exchangeable kits size 09	Exchangeable kits size 11	Exchangeable kits size 12	Exchangeable kits size 13	Exchangeable kits size 14
<p><b>Usable area:</b> 150 x 170 mm</p>  <p><b>ATS MA09/S-5</b> Part no.: 45990-KIT 210 x 243 x 201 mm (W x D x H)</p>	<p><b>Usable area:</b> 150 x 240 mm</p>  <p><b>ATS MA11/S-5</b> Part no.: 45898-KIT 210 x 313 x 201 mm (W x D x H)</p>	<p><b>Usable area:</b> 285 x 240 mm</p>  <p><b>ATS MA12/S-7</b> Part no.: 45903-KIT 350 x 313 x 201 mm (W x D x H)</p>	<p><b>Usable area:</b> 440 x 310 mm</p>  <p><b>ATS MA13/S-10</b> Part no.: 45908-KIT 506 x 383 x 205 mm (W x D x H)</p>	<p><b>Usable area:</b> 540 x 310 mm</p>  <p><b>ATS MA14/S-10</b> Part no.: 45983-KIT 606 x 383 x 205 mm (W x D x H)</p>
 <p><b>ATS MA09</b> Part no.: 45994-KIT 210 x 237 x 197 mm (W x D x H)</p>	 <p><b>ATS MA11</b> Part no.: 45900-KIT 210 x 307 x 197 mm (W x D x H)</p>	 <p><b>ATS MA12</b> Part no.: 45904-KIT 350 x 307 x 197 mm (W x D x H)</p>	 <p><b>ATS MA13</b> Part no.: 45980-KIT 506 x 377 x 205 mm (W x D x H)</p>	 <p><b>ATS MA14</b> Part no.: 45985-KIT 606 x 377 x 205 mm (W x D x H)</p>
 <p><b>ATS MA09/S-5/ESD</b> Part no.: 46233-KIT 210 x 243 x 203 mm (W x D x H)</p>	 <p><b>ATS MA11/S-5/ESD</b> Part no.: 46026-KIT 210 x 313 x 203 mm (W x D x H)</p>	 <p><b>ATS MA12/S-7/ESD</b> Part no.: 46236-KIT 350 x 313 x 203 mm (W x D x H)</p>	 <p><b>ATS MA13/S-10/ESD</b> Part no.: 46239-KIT 506 x 383 x 207 mm (W x D x H)</p>	 <p><b>ATS MA14/S-10/ESD</b> Part no.: 46242-KIT 606 x 383 x 207 mm (W x D x H)</p>
 <p><b>ATS MA09/ESD</b> Part no.: 46245-KIT 210 x 237 x 199 mm (W x D x H)</p>	 <p><b>ATS MA11/ESD</b> Part no.: 46248-KIT 210 x 307 x 199 mm (W x D x H)</p>	 <p><b>ATS MA12/ESD</b> Part no.: 46250-KIT 350 x 307 x 199 mm (W x D x H)</p>	 <p><b>ATS MA13/ESD</b> Part no.: 46254-KIT 506 x 377 x 207 mm (W x D x H)</p>	 <p><b>ATS MA14/ESD</b> Part no.: 46257-KIT 606 x 377 x 207 mm (W x D x H)</p>
<p><b>Usable area:</b> 100 x 160 mm</p>				
 <p><b>ATS MA11/S-5/HF</b> Part no.: 54111 210 x 313 x 276 mm (W x D x H)</p>				
 <p><b>ATS MA12/S-7/HF</b> Part no.: 54112 350 x 313 x 288 mm (W x D x H)</p>				
 <p><b>ATS MA13/S-10/HF</b> Part no.: 54113 506 x 383 x 278 mm (W x D x H)</p>				
 <p><b>ATS MA11/HF</b> Part no.: 54011 210 x 313 x 276 mm (W x D x H)</p>				
 <p><b>ATS MA12/HF</b> Part no.: 54012 350 x 313 x 288 mm (W x D x H)</p>				
 <p><b>ATS MA13/HF</b> Part no.: 54013 506 x 383 x 278 mm (W x D x H)</p>				

**Note:**

- Parts with the ending "-KIT" are delivered unassembled. This enables immediate DUT-specific processing.
- Stacking screws (part no. 41367 or part no. 44186) are included in delivery of standard or RF exchangeable kits. Stacking screws (part no. 52394) for standard interchangeable kits, which are customised in accordance with low voltage guidelines are included in delivery of the additional protection plates (part no. 41809, 41811, 41812, 41813, 41814).

# Pneumatic test fixture (PAZ/PA)

- Pneumatic test fixture PAZ xxx
- Pneumatic test fixture PA xxxx



# PAZ / PA

## Pneumatic interchangeable test fixture for series testing

Pneumatic test fixtures are available in two versions. The test fixtures in the **PAZ xxx** series are pneumatically operated test fixtures with gear wheel drive. The test fixtures in the **PA xxxx** series are pneumatically operated test fixtures with cam disc.

As standard, the test fixtures are equipped with safety switches for detecting whether the pressure frame is closed, and if reinforcing bars and circumferential finger guard are correctly positioned. The support with compressed air results in increased ease of use, without significant clamping forces for large contact forces.

They are available as an **interchangeable test fixtures** and are operated with a **exchangeable kit** that can be set up with little effort and without tools, or any need for readjustment.

The pressure frame plate, which can only be loosened and replaced with an open pressure frame unit, is held in place with four quick-release fasteners.

The parallel **contact stroke** is generated by adding compressed air to a pneumatically operated actuator that is used to actuate the gear wheel drive in the PAZ xxx series of test fixtures and the cam disc in the PA xxxx series of test fixtures via the lifting rod.

The test fixtures are designed for extra-low voltage (PELV) and comply with protection class III. They have no control unit of their own. The actuation of the pneumatic valves must be done by the customer.

### PAZ xxx test fixture

Operating elements and functional units

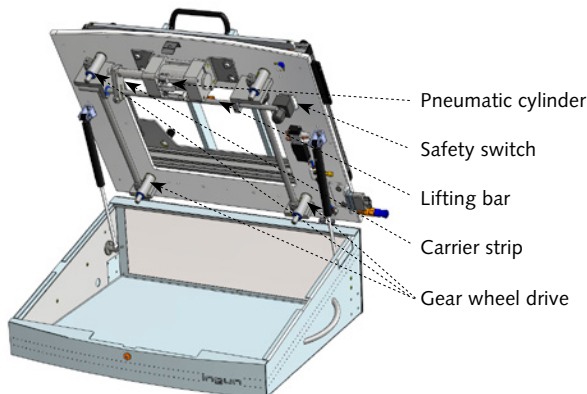
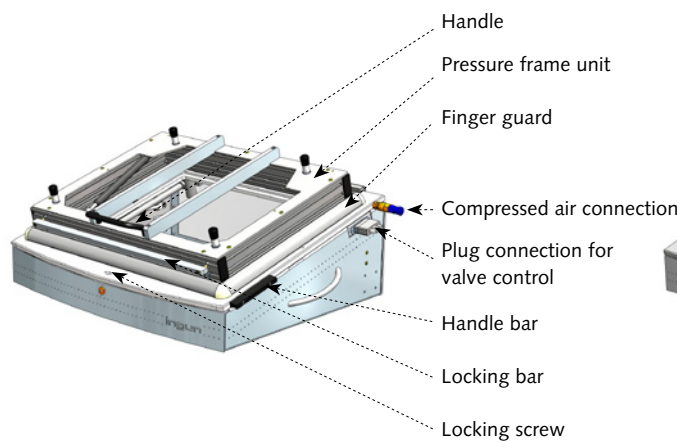

### PA xxx test fixture

Operating elements and functional units

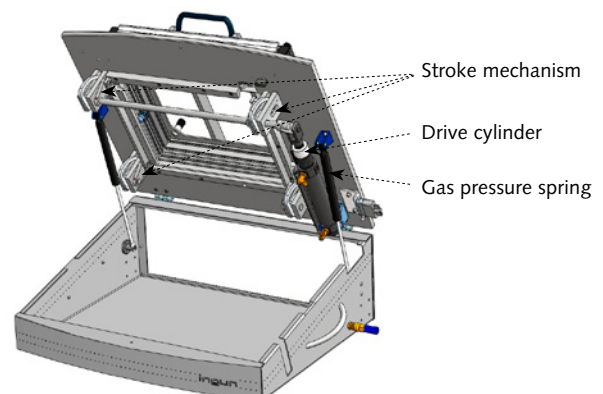
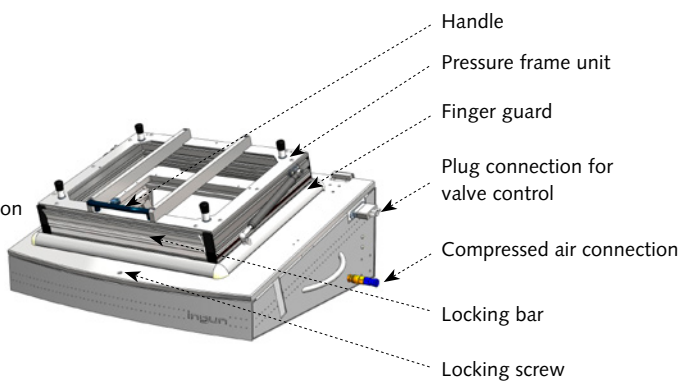

**CE** The pneumatic test fixtures PAZ / PA are designed as partly completed machinery and comply with the applicable requirements of the EC Machinery Directive 2006/42/EC (Article 13).



Size
 <p>PAZ 200</p>
 <p>PAZ 220</p>
 <p>PAZ 215</p>
 <p>PAZ 400</p>
 <p>PAZ 500</p>
 <p>PA 2130</p>

**Usage**

Test fixtures of the PAZ/PA series are suitable for contacting electronic units such as printed circuit boards (PCBs) with medium quantities (series testing) and a large number of versions. The test fixtures are designed as interchangeable kit system, are connected to an existing test system and are operated with exchangeable kits that are specially designed for the electronic unit to be tested.

**Features**

- Interchangeable kit system
- High contact force of up to 2,500 N
- Increased ease of use, without significant clamping forces
- Energy-saving opening mechanism
- Basic unit including stiffener bars and circumferential finger guard
- Individually loaded internal interface
- Exchangeable kits available as standard and ESD version, tool-free, and can be used without readjustment

**Life span**

- 1,000,000 load cycles (laboratory conditions)  
 The life span is determined in the laboratory using fully automatic, computer-controlled endurance test stations under full load. Since the life span depends on many different factors and in particular on the individual test application, INGUN does not guarantee the actual duration of use in the test field.

**Internal interface**

The unloaded internal interface depending on the design of the exchangeable kit can either be freely defined, loaded with VG male multipoint connectors (64-pin or 96-pin) or with contact terminals with wire-wrap posts. VG male multipoint connectors can be found on page 205, contact terminals on page 211.

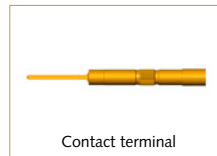
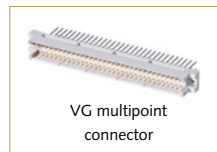

**Customising**

INGUN provides customising documents for customisation. The exchangeable kits are to be customised according to **info 1454** (ATS PAZ200), **info 1455** (ATS PAZ500), **info 1456** (ATS PAZ215) or **info 1460** (ATS PA2130).

Starter kits for customising on site and other customising accessories, such as pushrods, PCB support pins, tooling pins, pre-centring pins, marking units and test plugs, can be found from page 153 onwards.

**PAZ - Test fixture**

PAZ 200	82
PAZ 200-1	82
PAZ 220	83
PAZ 215	83
PAZ 400	84
PAZ 500-1	84

**ATS PAZ - Exchangeable kits**

ATS PAZ200	82
ATS PAZ200/ESD	82
ATS PAZ200/680	82
ATS PAZ200/680/ESD	82
ATS PAZ220	83
ATS PAZ215	83
ATS PAZ400	84
ATS PAZ500/680	84
ATS PAZ500/680/ESD	84

**PA - Test fixture**

PA 2130	85
---------	----

**ATS PA - Exchangeable kits**

ATS PA2130	85
ATS PA2130/ESD	85

**Note**

Overview and comparison table see page 86.

# PAZ 200

Pneumatic interchangeable test fixture for series testing

Series: PAZ xxx  
 Contact force: 1,000 N  
 Parallel stroke: 15 mm  
 Maximum usable area: 230 x 200 mm  
 Load cycles: 1,000,000 (laboratory conditions)



PAZ xxx | ATS PAZxxx

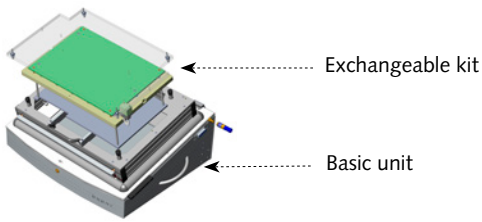

Basic unit **without** internal interface

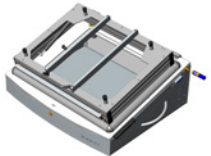

PAZ 200/D/H

Standard exchangeable kit **with** internal VG interface      ESD exchangeable kit **with** internal VG interface

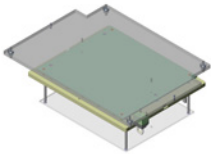

ATS PAZ200

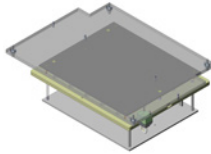

ATS PAZ200/ESD

Basic unit **with** internal GKS interface

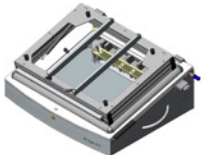

PAZ 200-1/D/H/680

Standard exchangeable kit **with** internal KT interface      ESD exchangeable kit **with** internal KT interface

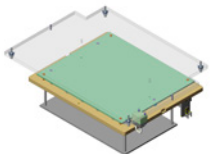

ATS PAZ200/680

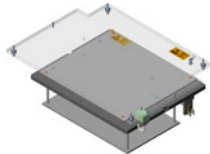

ATS PAZ200/680/ESD

## Features

- Fully closed pressure frame
- Includes safety switch on PAZ and activator on exchangeable kit
- Single-sided contacting from bottom side

## Technical specifications

### Basic unit

- Outer dimensions, closed (W x D x H):
  - PAZ 200/D/H: approx. 648 x 469 x 277 mm
  - PAZ 200-1/D/H/680: approx. 648 x 469 x 277 mm
- Pressure frame unit opening angle: approx. 60 °

### Exchangeable kit

- Usable area ATS (W x D):
  - ATS PAZ200: approx. 230 x 200 mm
  - ATS PAZ200/ESD: approx. 230 x 200 mm
  - ATS PAZ200/680: approx. 230 x 200 mm
  - ATS PAZ200/680/ESD: approx. 230 x 200 mm
- Free height above PCB: approx. 36 mm
- Pushrod length: 36.4 mm
- GKS installation height, bottom: 10.5 mm
- GKS theoretical working stroke: 3.7 mm (bottom)

### General

- Permissible test voltage: 25 V AC / 60 V DC
- Compressed air supply: 0.4 - 0.6 MPa
- Operating temperature range: + 10 °C to + 60 °C

### Internal interface

- ATS PAZ200(/ESD):

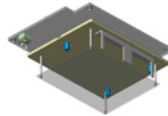

max. 8 VG male multipoint connectors (64 | 96-pole) for 512 | 768 signals, not included

- ATS PAZ200/680(/ESD):



max. 680 KT-254 W3 E03 (wire wrap connection), not included

- PAZ 200-1/D/H/680:

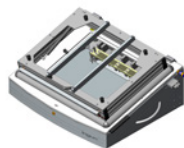

max. 680 GKS-912 207 150 A 1502 (not included) in:

- KS-112 47 (wire wrap connection)



- KS-112 30 (solder connection)



## Ordering information

Basic units		
Part no.:	13694	PAZ 200/D/H
		Pneumatic interchangeable test fixture without internal interface
Part no.:	19562	PAZ 200-1/D/H/680
		Pneumatic interchangeable test fixture with internal GKS interface
Exchangeable kits		
Part no.:	13988	ATS PAZ200
		Standard exchangeable kit with probe plate (KTP) made of CEM-1
Part no.:	30683	ATS PAZ200/ESD
		ESD exchangeable kit with probe plate (KTP) made of CEM-1
Part no.:	15918	ATS PAZ200/680
		Standard exchangeable kit with probe plate (KTP) made of CEM-1
Part no.:	43020	ATS PAZ200/680/ESD
		ESD exchangeable kit with probe plate (KTP) made of FR4 (ESD-coated)

PAZ xxx | ATS PAZxxx

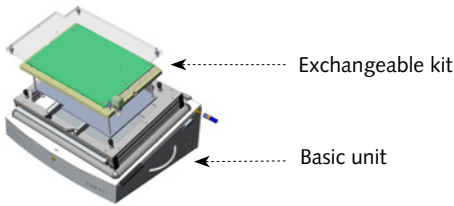

Basic unit **without**  
 internal interface

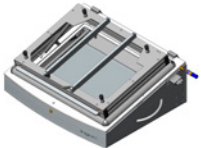

PAZ 220/D/H

Standard exchangeable kit **with**  
 internal VG interface

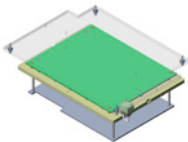

ATS PAZ220

Basic unit **without**  
 internal GKS interface

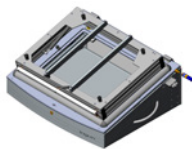

PAZ 215/D/H

Standard exchangeable kit **with**  
 internal VG interface

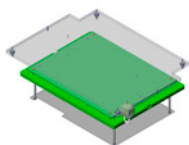

ATS PAZ215

### Features

- Fully closed pressure frame unit
- Includes safety switch on PAZ and activator on exchangeable kit
- Single-sided contacting from bottom side

### Technical specifications

#### Basic unit

- Outer dimensions, closed (W x D x H):
  - PAZ 220/D/H: approx. 648 x 469 x 277 mm
  - PAZ 215/D/H: approx. 648 x 469 x 277 mm
- Maximum contact force:
  - PAZ 220/D/H: 1,000 N
  - PAZ 215/D/H: 1,500 N
- Pressure frame unit opening angle: approx. 60 °

#### Exchangeable kit

- Usable area ATS (W x D):
  - ATS PAZ220: approx. 260 x 200 mm
  - ATS PAZ215: approx. 260 x 200 mm
- Free height above PCB: approx. 36 mm
- Pushrod length: 36.4 mm
- GKS installation height, bottom: 10.5 mm
- GKS theoretical working stroke: 3.7 mm (bottom)

#### General

- Permissible test voltage: 25 V AC / 60 V DC
- Compressed air supply: 0.4 - 0.6 MPa
- Operating temperature range: + 10 °C to + 60 °C

#### Internal interface

- ATS PAZ220:

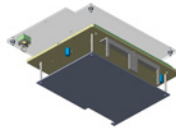

max. 8 VG male multipoint  
 connectors (64 | 96-pole) for  
 512 | 768 signals, not included



- ATS PAZ215:

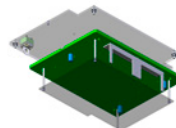

max. 8 VG male multipoint  
 connectors (64 | 96-pole) for  
 512 | 768 signals, not included



## Ordering information

Basic units		
Part no.:	18967	PAZ 220/D/H
		Pneumatic interchangeable test fixture without internal interface
Part no.:	18956	PAZ 215/D/H
		Pneumatic interchangeable test fixture without internal interface
Exchangeable kits		
Part no.:	18968	ATS PAZ220
		Standard exchangeable kit with probe plate (KTP) made of CEM-1
Part no.:	18958	ATS PAZ215
		Standard exchangeable kit with probe plate made (KTP) made of FR4

# PAZ 400 / PAZ 500

Pneumatic interchangeable test fixture for series testing

Series: PAZ xxx  
 Contact force: 1,500 N | 2,500 N  
 Parallel stroke: 15 mm  
 Maximum usable area: 500 x 180 mm  
 Load cycles: 1,000,000 (laboratory conditions)



PAZ xxx | ATS PAZxxx

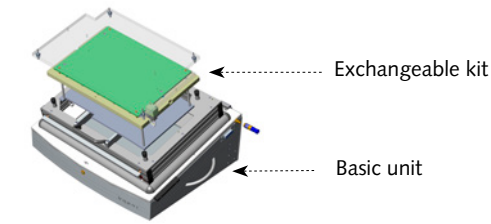

Basic unit **without** internal interface

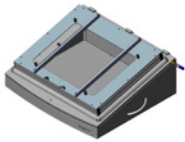

PAZ 400/D/H

Standard exchangeable kit **without** internal interface

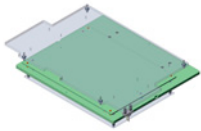

ATS PAZ400

Basic unit **with** internal GKS interface

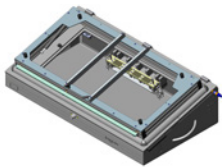

PAZ 500-1/D/H/680

Standard-exchangeable kit **with** internal KT interface

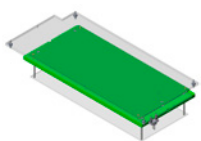

ATS PAZ500/680

ESD-exchangeable kit **with** internal KT interface

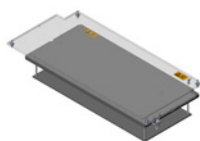

ATS PAZ500/680/ESD

## Features

- Fully closed pressure frame unit
- Includes safety switch on PAZ and activator on exchangeable kit
- Single-sided contacting from bottom side

## Technical specifications

### Basic unit

- Outer dimensions, closed (W x D x H):
  - PAZ 400/D/H: approx. 768 x 604 x 300 mm
  - PAZ 500-1/D/H/680: approx. 908 x 468 x 260 mm
- Maximum contact force:
  - PAZ 400/D/H: 1,500 N
  - PAZ 500-1/D/H/680: 2,500 N
- Pressure frame unit opening angle: approx. 60 °

### Exchangeable kit

- Usable area ATS (W x D):
  - ATS PAZ400: approx. 350 x 250 mm
  - ATS PAZ500/680: approx. 500 x 180 mm
  - ATS PAZ500/680/ESD: approx. 500 x 180 mm
- Free height above PCB: approx. 36 mm
- Pushrod length: 36.4 mm
- GKS installation height, bottom: 10.5 mm
- GKS theoretical working stroke: 3.7 mm (bottom)

### General

- Permissible test voltage: 25 V AC / 60 V DC
- Compressed air supply: 0.4 - 0.6 MPa
- Operating temperature range: + 10 °C to + 60 °C

### Internal interface

- ATS PAZ400:

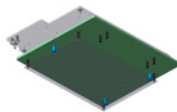

freely definable, VG strips (64 | 96-pole) recommended



- ATS PAZ500/680(/ESD):

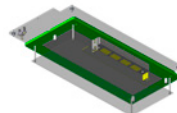

max. 680 KT-254 W3 E03 (wire wrap connection), not included



- PAZ 500-1/D/H/680:

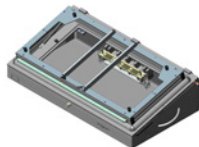

max. 680 GKS-912 207 150 A 1502 (not included) in:



- KS-112 47 (wire wrap post)



- KS-112 30 (soldered connection)



## Ordering information

Basic units			
Part no.:	28489	PAZ 400/D/H	Pneumatic interchangeable test fixture without internal interface
Part no.:	31155	PAZ 500-1/D/H/680	Pneumatic interchangeable test fixture with internal GKS interface
Exchangeable kits			
Part no.:	28491	ATS PAZ400	Standard exchangeable kit with probe plate (KTP) made of FR4
Part no.:	31156	ATS PAZ500/680	Standard exchangeable kit with probe plate (KTP) made of FR4
Part no.:	42351	ATS PAZ500/680/ESD	ESD exchangeable kit with probe plate (KTP) made of FR4 (ESD-coated)

PA xxxx | ATS PAxxxx

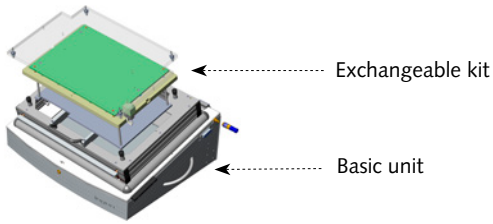

Basic unit **without** internal interface

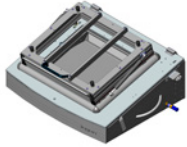

PA 2130/D/H

Standard exchangeable kit **without** internal interface

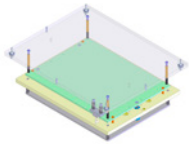

ATS PA2130

ESD exchangeable kit **without** internal interface

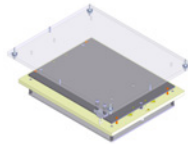

ATS PA2130/ESD

**Features**

- Fully closed pressure frame unit
- Includes safety switch on PAZ and activator on exchangeable kit
- Single-sided or double-sided contacting

**Technical specifications**

**Basic unit**

- Outer dimensions, closed (W x D x H):  
 - PA 2130/D/H: approx. 648 x 469 x 273 mm
- Pressure frame unit opening angle: approx. 60 °

**Exchangeable kit**

- Usable area ATS (W x D):  
 - ATS PA2130: approx. 250 x 200 mm  
 - ATS PA2130/ESD: approx. 250 x 200 mm
- Free height above PCB: approx. 49 mm
- Pushrod length: 51 mm
- GKS installation height, bottom: 10.5 mm
- GKS installation height, top: 16.0 mm
- GKS theoretical working stroke: 3.7 mm (bottom), 3.5 mm (top)

**General**

- Permissible test voltage: 25 V AC / 60 V DC
- Compressed air supply: 0.4 - 0.6 MPa
- Operating temperature range: + 10 °C to + 60 °C

**Internal interface**

- ATS PA2130(/ESD): freely definable, VG male multipoint connector (64 | 96-pole) recommended

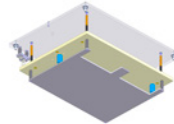

**Ordering information**

Basic units		
Part no.:	20598	PA 2130/D/H Pneumatic interchangeable test fixture without internal interface
Exchangeable kits		
Part no.:	21117	ATS PA2130 Standard exchangeable kit with probe plate (KTP) made of CEM-1
Part no.:	30668	ATS PA2130/ESD ESD exchangeable kit with probe plate (KTP) made of CEM-1



Description	PAZ 200/ D/H	PAZ 200-1/ D/H/680	PAZ 220/ D/H	PAZ 215/ D/H	PAZ 400/ D/H	PAZ 500-1/ D/H/680	PA 2130/ D/H
<b>PAZ/PA part number</b>	13694	19562	18967	18956	28489	31155	20598
<b>ATS part number</b>	13988	15918	18968	18958	28491	31156	21117
<b>ATS/ESD part number</b>	30683	43020	-	-	-	42351	30668
<b>Contact force</b>	1,000 N	1,000 N	1,000 N	1,500 N	1,500 N	2,500 N	700 N
<b>Parallel stroke (mm)</b>	15	15	15	15	15	15	15
<b>Outer dimensions, closed (W x D x H mm)</b>	648 x 469 x 277	648 x 469 x 277	648 x 469 x 277	648 x 469 x 277	768 x 604 x 300	908 x 468 x 260	648 x 469 x 273
<b>ATS usable area (W x D mm)</b>	230 x 200	230 x 200	260 x 200	260 x 200	350 x 250	500 x 180	250 x 200
<b>ATS/ESD usable area (W x D mm)</b>	230 x 200	230 x 200	-	-	-	500 x 180	250 x 200
<b>Pressure frame unit - opening angle</b>	60 °	60 °	60 °	60 °	60 °	60 °	60 °
<b>Free height above PCB (mm)</b>	36	36	36	36	36	36	49
<b>Pushrod length (mm)</b>	36.4	36.4	36.4	36.4	36.4	36.4	51
<b>GKS installation height, bottom (mm)</b>	10.5	10.5	10.5	10.5	10.5	10.5	10.5
<b>GKS installation height, top (mm)</b>	-	-	-	-	-	-	16.0
<b>GKS theoretical working stroke, bottom (mm)</b>	3.7	3.7	3.7	3.7	3.7	3.7	3.7
<b>GKS theoretical working stroke, top (mm)</b>	-	-	-	-	-	-	3.5
<b>Permissible test voltage (Safety extra low voltage)</b>	25 V AC/ 60 V DC	25 V AC/ 60 V DC	25 V AC/ 60 V DC	25 V AC/ 60 V DC	25 V AC/ 60 V DC	25 V AC/ 60 V DC	25 V AC/ 60 V DC
<b>Compressed air supply</b>	0.4 - 0.6 MPa	0.4 - 0.6 MPa	0.4 - 0.6 MPa	0.4 - 0.6 MPa	0.4 - 0.6 MPa	0.4 - 0.6 MPa	0.4 - 0.6 MPa
<b>Operating temperature range</b>	+ 10 °C to + 60 °C	+ 10 °C to + 60 °C	+ 10 °C to + 60 °C	+ 10 °C to + 60 °C	+ 10 °C to + 60 °C	+ 10 °C to + 60 °C	+ 10 °C to + 60 °C
<b>Internal interface PAZ/PA</b>	-	max. 680x GKS-912 207 150 A 1502 in (or) - KS-112 47 - KS-112 30	-	-	-	max. 680x GKS-912 207 150 A 1502 in (or) - KS-112 47 - KS-112 30	-
<b>Internal interface ATS</b>	max. 8x VG multipoint connector	max. 680x KT-254 W3 E03	max. 8x VG multipoint connector	max. 8x VG multipoint connector	freely definable (VG-strips recom- mended)	max. 680x KT-254 W3 E03	freely definable (VG-strips recom- mended)
<b>Internal interface ATS/ESD</b>	max. 8x VG multipoint connector	max. 680x KT-254 W3 E03	-	-	-	max. 680x KT-254 W3 E03	freely definable (VG-strips recom- mended)

# Vacuum test fixtures (VA)

- Vacuum test fixture VA product information
- Vacuum test fixture without test system interface
- Vacuum test fixture with test system interface
  - COBHAM (AEROFLEX)
  - DIGITALTEST
  - KEYSIGHT
  - REINHARDT
  - SPEA
  - TERADYNE
  - PYLON
  - VIRGINIA PANEL



# Vacuum test fixture

## Compatible with all common test systems and interfaces

**Vacuum test fixtures (VA)** are designed as **stand-alone test fixtures**, primarily without **customisations**. They are available in different sizes with and without test system interface, and are compatible with all **common test systems and interfaces**.

The vacuum cassettes are designed for **single-sided, single-stage** or for **single-sided, dual-stage contacting** for performing the combined FCT/ICT test. The single-sided

dual-stage contacting is implemented with an electrically operated shifting plate. The ICT is performed in the first stage and the FCT test is performed in the second stage, which is approx. 5 mm above the first stage. With appropriate **customisations**, e.g. in the form of an additional contact unit (ZSK), an additional single-stage contact can be implemented from above, so that the vacuum test fixture is equipped for **double-sided contacting**.

<p><b>COBHAM</b> (AEROFLEX)</p> <p>VA 2040 </p> <p>VA 2140 </p> <p>VA 2601-2e </p> <p><u>Compatible with:</u> - 4200/4210 - 4200/4250</p>	<p><b>DIGITALTEST</b></p> <p>VA 2040 </p> <p>VA 2140 </p> <p>VA 2601-2e </p> <p><u>Compatible with:</u> - MTS 100 - MTS 200 - MTS 300</p>	<p><b>KEYSIGHT</b></p> <p>VA 2070/S </p> <p>VA 2073/L </p> <p><u>Compatible with:</u> - i3070 (Small + Large)</p>	<p><b>PYLON</b></p> <p>VA 2040 </p> <p>VA 2140 </p> <p>VA 2601-2e </p> <p><u>Compatible with:</u> - Pylon-10 - ITA-14</p>	<p><b>VPC</b></p> <p>VA 2040 </p> <p>VA 2601-2e </p> <p><u>Compatible with:</u> - VPC-G12-12 - VPC-G12x-18</p>
<p><b>REINHARDT</b></p> <p>VA 2035 </p> <p>VA 2035-2e </p> <p>VA 2040 </p> <p><u>Compatible with:</u> - VG-18</p>	<p><b>SPEA</b></p> <p>VA 2040 </p> <p>VA 2140 </p> <p>VA 2601-2e </p> <p><u>Compatible with:</u> - 501 - 3030</p>	<p><b>TERADYNE</b></p> <p>VA 2040 </p> <p>VA 2050 </p> <p>VA 2601-2e </p> <p><u>Compatible with:</u> - Z18xx, - 88xx (S/M) - TSO5x, - GR 228x - GR 2270/71</p>	<p><b>Pylon</b> interfaces are used for customer-specific test systems and test systems from <b>Dr. Eschke Elektronik</b> and <b>Rohde &amp; Schwarz</b>, among others.</p> <p><b>VPC</b> interfaces are used in customer-specific test systems and test systems from <b>Gedis, Konrad</b> and <b>Rohde &amp; Schwarz</b>, among others.</p> <div style="display: flex; justify-content: space-around; margin-top: 10px;"> <div style="border: 1px solid black; padding: 5px; background-color: #c08040; color: white;">Dr. ESCHKE</div> <div style="border: 1px solid black; padding: 5px; background-color: #c08040; color: white;">GEDIS</div> </div> <div style="display: flex; justify-content: space-around; margin-top: 10px;"> <div style="border: 1px solid black; padding: 5px; background-color: #c08040; color: white;">ROHDE &amp; SCHWARZ</div> <div style="border: 1px solid black; padding: 5px; background-color: #c08040; color: white;">KONRAD</div> </div> <div style="border: 1px solid black; padding: 5px; background-color: #c08040; color: white; margin-top: 10px; text-align: center;"> <b>Note:</b> Please contact us if your desired test system interface is not available.         </div>	

# Vacuum test fixtures

## Modular design and easy operation

The parallel **contact stroke with a height** of several millimetres is generated by means of negative pressure by suction of air into the vacuum zone. The vacuum seal enables the largest possible parallel stroke and increased sealing effect as the vacuum pressure increases. Thanks to the fixture's **modular design**, there are various ways to ensure the electronic unit makes contact with the

spring-loaded test probes. There is a wide variety of standardised **customisations**, such as vacuum covers, pressure frame units or DUT-specific sealing masks and additional contacts for implementing a complementary single-stage contacting from above. The customisations can be combined with almost all vacuum test fixtures in various sizes.

### VA test fixture Modular design

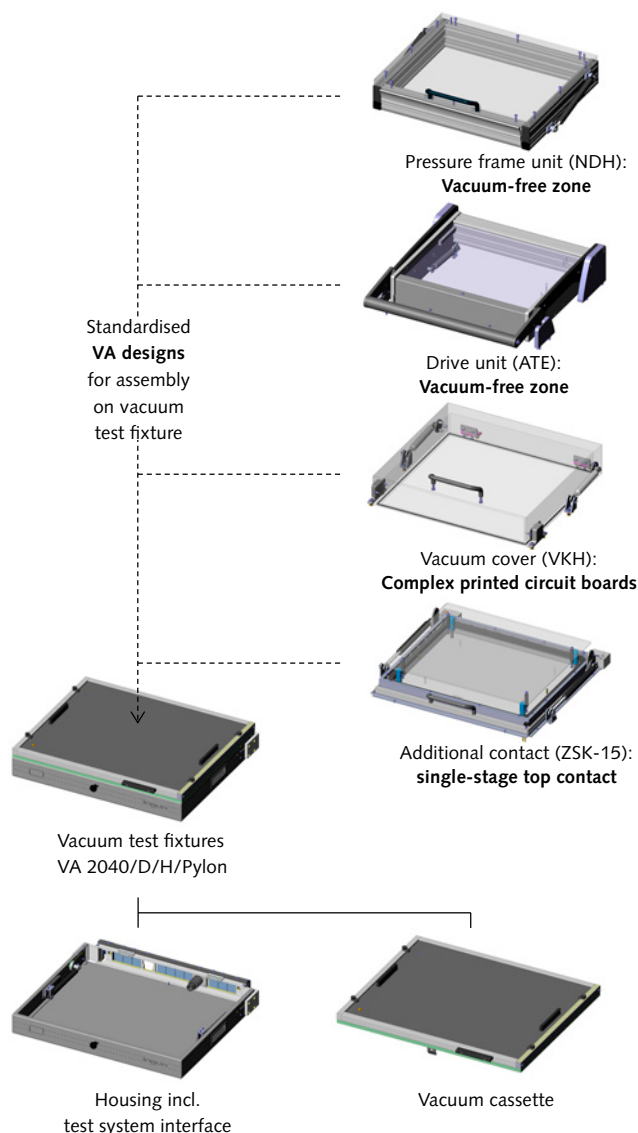

### VA test fixture Operating elements and functional units

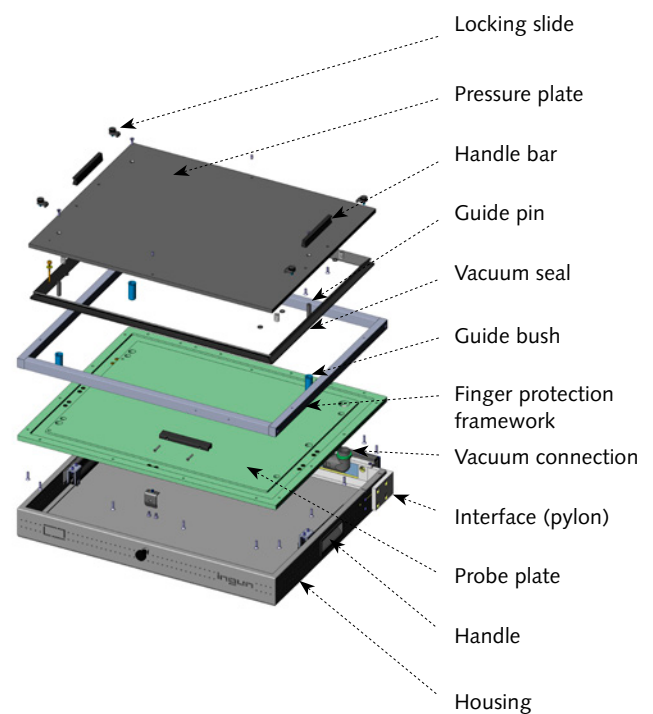

### Signal transmission

Signal transmission occurs from the wired receptacle directly to the test system interface without using an internal interface.

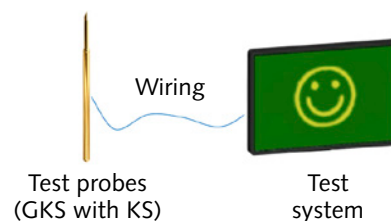

# Vacuum test fixtures

## Extensive portfolio in various sizes

The **designation** of the vacuum test fixture provides information about the product group, size, equipment and the intended test system. Depending on the size of the electronic

functional unit and the test system used, the correct **size** can be chosen from an extensive range.

Size	Usable area (typical)	Contact force (max.)	Parallel stroke	Contacting
<b>Standard single-stage versions</b>				
VA 2020	370 x 280 mm	12,000 N	approx. 8.5 mm	single-stage
VA 2030	345 x 215 mm	9,000 N		
VA 2035	305 x 305 mm	9,000 N		
VA 2040	435 x 330 mm	14,000 N		
VA 2050	395 x 385 mm	15,000 N		
VA 2060	535 x 440 mm	22,000 N		
VA 2070S	305 x 380 mm	11,000 N	approx. 7 mm	
VA 2070SR	305 x 230 mm	8,000 N		
VA 2073L	670 x 380 mm	24,000 N		
<b>Tandem single-stage versions</b>				
VA 2130	2x 130 x 220 mm	2x 4,000 N	approx. 8.5 mm	single-stage
VA 2140	2x 175 x 340 mm	2x 6,000 N		
VA 2050T	2x 150 x 370 mm	2x 7,000 N		
VA 2070ST	2x 100 x 380 mm	2x 5,000 N	approx. 7 mm	
<b>Standard dual-stage versions</b>				
VA 2020-2e	330 x 260 mm	12,000 N	approx. 12 mm	dual-stage
VA 2035-2e	265 x 265 mm	9,000 N		
VA 2501-2e	295 x 175 mm	9,000 N		
VA 2601-2e	385 x 290 mm	14,000 N		
VA 2070S-2e	270 x 335 mm	11,000 N		
VA 2073L-2e	650 x 335 mm	24,000 N		

Vacuum test fixture sorted by name and version



# Vacuum test fixtures without test system interface

Size
 <p>VA 2030</p>
 <p>VA 2130</p>
 <p>VA 2040</p>
 <p>VA 2140</p>
 <p>VA 2060</p>

### Usage

Vacuum test fixtures (VA) are suitable for contacting high-volume electronic units such as printed circuit boards (PCBs) (mass testing) and a small number of versions. The following vacuum test fixtures are available as a stand-alone system **without** interchangeable exchangeable kit and **without** test system interface. They are suitable for single-sided, single-stage contacting and are connected to an existing test system.

### Features

- Robust design
- Stand-alone system without interchangeable exchangeable kit
- Available in different versions
- Available in different sizes
- Without test system interface
- Can be used for single-sided, single-stage contacting

### Life span

- > 2,000,000 load cycles (laboratory conditions)  
The life span is determined in the laboratory with fully automatic, computer-controlled endurance test stations under full load. Since the life span depends on many different factors and in particular on the individual test application, INGUN does not guarantee the actual duration of use in the test field.

### VA designs

Standardised customisations, such as vacuum covers, pressure frame units or additional contact units can be found from page 132 onwards.



### Customising

INGUN provides customising documents for customisation. The vacuum test fixtures are to be customised according to the customising guidelines **info 1732**.

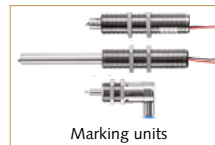

Pushrods, PCB support pins, tooling pins, pre-centring pins and other accessories, such as marking units and test plugs can be found from page 153 onwards.

### Vacuum test fixture without test system interface

VA 2030	92
VA 2130	92
VA 2040	92
VA 2140	92
VA 2060	92
VA 2030/rigid pin	93
VA 2040/rigid pin	93

Note  
See page 94 for overview and comparison table.  
See pages 130 to 131 for product overview.

## Contacting single-sided, single-stage (bottom)

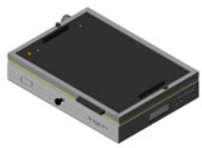

VA 2030/F/H/VAL

- Probe plate (KTP) made of CEM-1
- 1x VA connection with  $\varnothing = 32$  mm

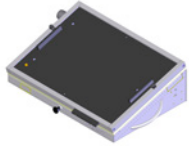

VA 2030/D/H/VAL

- Probe plate (KTP) made of CEM-1
- 1x VA connection with  $\varnothing = 32$  mm

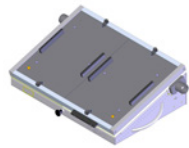

VA 2130/D/H

- Tandem version
- Probe plate (KTP) made of CEM-1
- 2x VA connection with  $\varnothing = 32$  mm

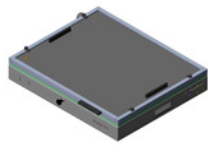

VA 2040/F/H/VAL

- Probe plate (KTP) made of FR4
- 1x VA connection with  $\varnothing = 32$  mm

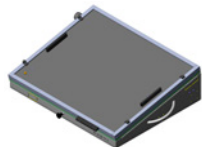

VA 2040/D/H/VAL

- Probe plate (KTP) made of FR4
- 1x VA connection with  $\varnothing = 32$  mm

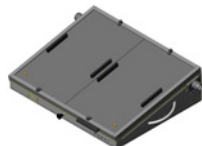

VA 2140/D/H

- Tandem version
- Probe plate (KTP) made of CEM-1
- 2x VA connection with  $\varnothing = 32$  mm

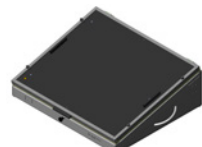

VA 2060/D/H/PG16

- Probe plate (KTP) made of CEM-1
- 1x VA connection PG16 (internally)

## Features

- Standard or tandem version without test system interface
- 10 mm thick probe plate (KTP) made of CEM-1 or FR4
- Single-sided, single-stage contacting

## Technical specifications

### Vacuum test fixtures

- Maximum contact force: see table on page 90
- Parallel stroke: see table on page 90
- Outer dimensions (W x D x H):
  - VA 2030/F/H/VAL: approx. 505 x 367 x 105 mm
  - VA 2030/D/H/VAL: approx. 537 x 352 x 153 mm
  - VA 2130/D/H: approx. 545 x 352 x 165 mm
  - VA 2040/F/H/VAL: approx. 595 x 487 x 105 mm
  - VA 2040/D/H/VAL: approx. 627 x 473 x 158 mm
  - VA 2140/D/H: approx. 635 x 475 x 165 mm
  - VA 2060/D/H/PG16: approx. 720 x 575 x 225 mm
- Usable area (W x D):
  - VA 2030: approx. 345 x 215 mm
  - VA 2130: approx. 2x 130 x 220 mm
  - VA 2040: approx. 435 x 330 mm
  - VA 2140: approx. 2x 175 x 340 mm
  - VA 2060: approx. 535 x 440 mm
- GKS installation height, bottom: 16.0 mm
- GKS theoretical working stroke: 4.0 mm (bottom)
- Operating temperature range: + 10 °C to + 60 °C

## Ordering information

Vacuum stand-alone test fixture		
Single-stage contacting (ICT/FCT stand-alone)		
Part no.:	4753	VA 2030/F/H/VAL
		KTP made of CEM-1, 1x VA connection with $\varnothing = 32$ mm
Part no.:	4979	VA 2030/D/H/VAL
		KTP made of CEM-1, 1x VA connection with $\varnothing = 32$ mm
Part no.:	12699	VA 2130/D/H
		Tandem, KTP made of CEM-1, 2x VA connection with $\varnothing = 32$ mm
Part no.:	4982	VA 2040/F/H/VAL
		KTP made of FR4, 1x VA connection with $\varnothing = 32$ mm
Part no.:	4980	VA 2040/D/H/VAL
		KTP made of FR4, 1x VA connection with $\varnothing = 32$ mm
Part no.:	12700	VA 2140/D/H
		Tandem, KTP made of CEM-1, 2x VA connection with $\varnothing = 32$ mm
Part no.:	32352	VA 2060/D/H/PG16
		KTP made of CEM-1, 1x VA connection PG16 (internally)

In the case of vacuum test fixtures without test system interface, the rear panel can be machined for mounting of, e.g. VG multi-point connectors (64 | 96-pole) or Sub-D connectors (50-pole).

## Contacting single-sided, single-stage (bottom)

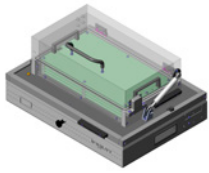

VA 2030/F/H/SN

- Probe plate (KTP) made of CEM-1
- 1x VA connection PG16 (internally)
- Incl. vacuum cover with quick lock, 13 N retention force

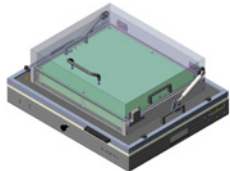

VA 2040/F/H/SN

- Probe plate (KTP) made of FR4
- 1x VA connection PG16 (internally)
- Incl. vacuum cover with quick lock, 13 N retention force

## Rigid pin customisation

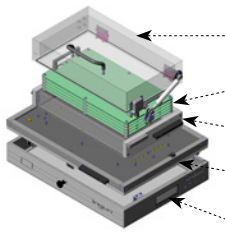

- Vacuum cover
- Rigid pin unit
- Rigid pin frame
- Vacuum cassette
- Flat housing

## Function

**Rigid pin test fixtures** are used to test small test points in small grids in order to precisely and reliably contact them with a high spring force. The deflection of rigid pins at a certain angle is calculated by the automated conversion of the test points to be contacted on the grid. For contacting, rigid pins with the head shapes 01 (self-cleaning 30° needle tip), 06 (ser-ranted), 07 (90° 3-edge chisel) and 14 (self-cleaning 4-point crown) are available.

## Features

- Rigid pin version
  - Contact area diameter 0.30 mm (\*)
  - Minimum test point grid of 0.50 mm (\*)
  - Contacting on pads, vias and pins
  - Easy, fast and tool-free replacement of rigid pins
  - Marking units (Part no.: 24456) and actuator elements easily integrable
  - Single-sided, single-stage rigid pin contacting
- \*: without PCB tolerances, when customised by INGUN

## Technical specifications

### Vacuum test fixtures

- Maximum contact force: see table on page 90
- Parallel stroke: see table on page 90
- Outer dimensions (W x D x H):
  - VA 2030/F/H/SN: approx. 460 x 368 x 254 mm
  - VA 2040/F/H/SN: approx. 550 x 486 x 254 mm
- Maximum sample size (W x D):
  - VA 2030/F/H/SN: approx. 305 x 155 mm
  - VA 2040/F/H/SN: approx. 365 x 295 mm
- Maximum test area (W x D):
  - VA 2030/F/H/SN: approx. 290 x 140 mm
  - VA 2040/F/H/SN: approx. 350 x 280 mm
- Vacuum cover opening angle: approx. 85 °
- Free height above PCB: approx. 53.6 mm
- Pushrod length: 55.6 mm
- GKS installation height, bottom: 16.0 mm
- GKS theoretical working stroke: 4.0 mm (bottom)
- Operating temperature range: + 10 °C to + 60 °C

## Ordering information

Vacuum stand-alone test fixture		
Single-stage rigid pin contacting (ICT/FCT stand-alone)		
Part no.: 27735	VA 2030/F/H/SN	Rigid pin, KTP made of CEM-1, 1x VA connection PG16 (internally)
Part no.: 27737	VA 2040/F/H/SN	Rigid pin, KTP made of FR4, 1x VA connection PG16 (internally)

In the case of vacuum test fixtures without test system interface, the back panel can be machined for mounting of, e.g. VG multi-point connectors (64 | 96-pole) or Sub-D connectors (50 pole).

Description	Part number	Version	Test system interface	Contacting	Max. contact force [N]	Parallel stroke [mm]	Outer dimensions (W x D x H mm)	Typical usable area (W x D mm)
<b>VA 2030/F/H/VAL</b>	4753	Standard	-	single-stage	9,000	8.5	505 x 367 x 105	345 x 215
<b>VA 2030/D/H/VAL</b>	4979	Standard	-	single-stage	9,000	8.5	537 x 352 x 153	345 x 215
<b>VA 2130/D/H</b>	12699	Tandem	-	single-stage	2x 4,000	8.5	545 x 352 x 165	2x 130 x 220
<b>VA 2040/F/H/VAL</b>	4982	Standard	-	single-stage	14,000	8.5	595 x 487 x 105	435 x 330
<b>VA 2040/D/H/VAL</b>	4980	Standard	-	single-stage	14,000	8.5	627 x 473 x 158	435 x 330
<b>VA 2140/D/H</b>	12700	Tandem	-	single-stage	2x 6,000	8.5	635 x 475 x 165	2x 175 x 340
<b>VA 2060/D/H/PG16</b>	32352	Standard	-	single-stage	22,000	8.5	720 x 575 x 225	535 x 440
<b>VA 2030/F/H/SN</b>	27735	Rigid pin incl. vacuum cover	-	single-stage (rigid pin)	9,000	8.5	460 x 368 x 254	305 x 155
<b>VA 2040/F/H/SN</b>	27737	Rigid pin incl. vacuum cover	-	single-stage (rigid pin)	14,000	8.5	550 x 486 x 254	365 x 295

# Vacuum test fixtures with test system interface

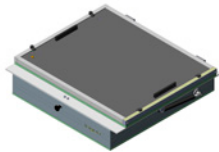
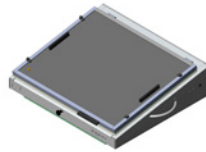
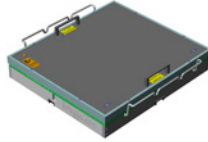
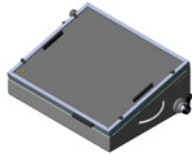
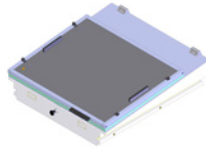
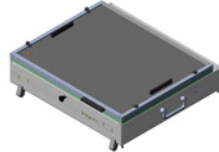
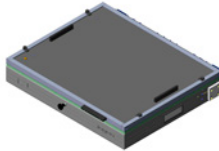
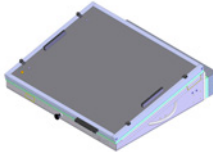
Test systems and interfaces
 COBHAM (AEROFLEX)
 DIGITALTEST
 KEYSIGHT
 REINHARDT
 SPEA
 TERADYNE
 PYLON
 VPC

**Usage**

Vacuum test fixtures (VA) are suitable for contacting electronic functional units with high quantities (mass testing) and a small number of versions. The following vacuum test fixtures are available as a stand-alone system without interchangeable exchangeable kit and **with** test system interface. They can be used for single-sided, single-stage or dual-stage contacting, and are connected to an existing test system.

**Features**

- Robust design
- Compatible with all common test systems and interfaces
- Stand-alone system without interchangeable replacement kit
- Available in different versions
- Available in different sizes
- With test system interface
- Can be used for single-sided, single-stage or dual-stage contacting

**Life span**

> 2,000,000 load cycles (laboratory conditions)  
The life span is determined in the laboratory with fully automatic, computer-controlled endurance test stations under full load. Since the life span depends on many different factors and in particular on the individual test application, INGUN does not guarantee the actual duration of use in the test field.

**VA designs**

Standardised customisations, such as vacuum covers, pressure frame units, or additional contact units can be found from page 132 onwards.



**Customising**

INGUN provides customising documents for customisation. The vacuum test fixtures are to be customised according to the customising guidelines **info 1732**.

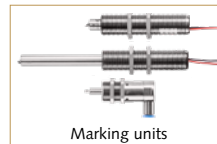

Pushrods, PCB support pins, tooling pins, pre-centring pins and other accessories, such as marking units and test plugs, can be found from page 153 onwards.

**Manual test fixtures**

Also note our manual test fixtures (MA) with test system interface from pages 38 to 45.

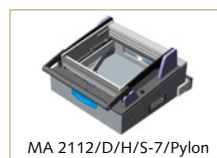

**Vacuum test fixture with test system interface**

COBHAM (AEROFLEX)	96
DIGITALTEST	97
KEYSIGHT	100
REINHARDT	109
SPEA	110
TERADYNE	112
PYLON	121
- Dr. ESCHKE	
- ROHDE & SCHWARZ	
PYLON RECEIVER	123
VPC	124
- GEDIS	
- KONRAD	
- ROHDE & SCHWARZ	

**Note**

See pages 126 to 129 for overview and comparison table.  
See pages 130 to 131 for product overview.



## Test system interface 4210

### Contacting single-sided, single-stage (bottom)

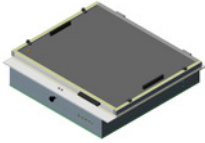

- Probe plate (KTP) made of CEM-1
- With cover stay

VA 2040/F/H/MC 4200/4210

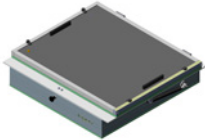

- Probe plate (KTP) made of FR4
- With gas pressure spring

VA 2040/F/H/MC 4200/4210

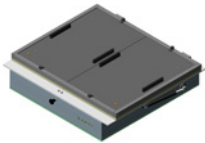

- Tandem version
- Probe plate (KTP) made of CEM-1
- With gas pressure spring

VA 2140/F/H/MC 4200/4210

### Contacting single-sided, dual-stage (bottom)

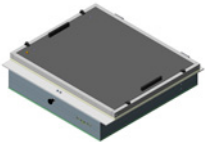

- Probe plate (KTP) made of CEM-1
- With cover stay
- Without electric drive

VA 2601-2/F/H/MC 4200/4210

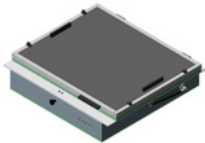

- Probe plate (KTP) made of FR4
- With gas pressure spring
- Incl. electric drive

VA 2601-2e/F/H/MC 4200/4210

## Test system interface 4250

### Contacting single-sided, single-stage (bottom)

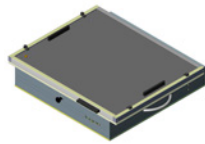

- Probe plate (KTP) made of CEM-1
- With cover stay

VA 2040/F/H/AF 4200/4250

## Features

- Standard or tandem version with test system interface
- 10 mm thick probe plate (KTP) made of CEM-1 or FR4
- Cover stay or gas pressure spring for holding the housing open
- Single-sided single-stage or dual-stage contacting
- Dual-stage contacting with electrically operated shifting plate

## Technical specifications

### Vacuum test fixtures

- Maximum contact force: see table on page 90
- Parallel stroke: see table on page 90
- Outer dimensions (W x D x H):
  - VA 2040/4210: approx. 550 x 557 x 137 mm
  - VA 2140/4210: approx. 550 x 557 x 137 mm
  - VA 2040/4250: approx. 550 x 532 x 132 mm
  - VA 2601-2(e)/4210: approx. 550 x 557 x 142 mm
- Usable area (W x D):
  - VA 2040: approx. 435 x 335 mm
  - VA 2140: approx. 2x 175 x 340 mm
  - VA 2601-2(e): approx. 385 x 290 mm
- GKS installation height, bottom: 16.0 mm
- GKS installation height, 2-stage, bottom: 16.0 | 21.5 mm
- GKS theoretical working stroke: 4.0 mm (bottom)
- Operating temperature range: + 10 °C to + 60 °C

### Test system interface

- AF 4200/4250: max. 2,848  
KT-158 02 (flat), not included

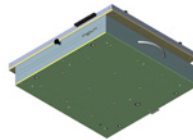

(see page 211)

## Ordering information

Vacuum stand-alone test fixture		
Single-stage contacting (ICT/FCT stand-alone)		
Part no.: 20229	VA 2040/F/H/MC 4200/4210	KTP made of CEM-1, with cover stay
Part no.: 9904	VA 2040/F/H/MC 4200/4210	KTP made of FR4, with gas pressure spring
Part no.: 12736	VA 2140/F/H/MC 4200/4210	Tandem, KTP made of CEM-1, with gas pressure spring
Part no.: 30625	VA 2040/F/H/AF 4200/4250	KTP made of CEM-1, with cover stay
Dual-stage contacting (ICT/FCT combined)		
Part no.: 25754	VA 2601-2/F/H/MC 4200/4210	KTP made of CEM-1, with cover stay, without electric drive
Part no.: 18210	VA 2601-2e/F/H/MC 4200/4210	KTP made of FR4, with gas pressure spring, incl. electric drive
Accessories		
Part no.: 21729	Electric drive	Electric drive with angular gear for VA 2601-2
Part no.: 16436	Spacer plate	Spacer plate for mounting the electric drive

**Test system interface MTS 100**

Contacting single-sided, single-stage (bottom)

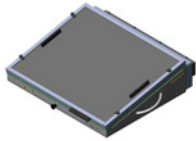

VA 2040/D/H/MTS 100

- Probe plate (KTP) made of FR4
- Incl. unloaded interface 24 VG multipoint connectors (32 pole)

**Test system interface MTS 200**

Contacting single-sided, single-stage (bottom)

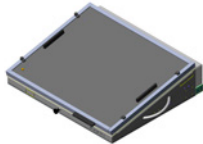

VA 2040/D/H/MTS 200

- Probe plate (KTP) made of CEM-1
- Incl. unloaded interface 1,918 KT-158

**Test system interface MTS 300**

Contacting single-sided, single-stage (bottom)

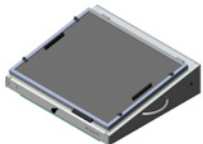

VA 2040/D/H/MTS 300

- Probe plate (KTP) made of CEM-1
- Incl. unloaded interface 4,352 KT-158



VA 2140/D/H/MTS 300

- Tandem version
- Probe plate (KTP) made of CEM-1
- Incl. unloaded interface 4,352 KT-158

Contacting single-sided, dual-stage (bottom)

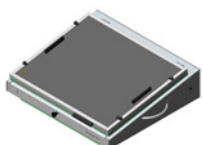

VA 2601-2e/D/H/MTS 300

- Probe plate (KTP) made of FR4
- Incl. unloaded interface 4,352 KT-158
- Incl. electric drive

**Features**

- Standard or tandem version with test system interface
- 10 mm thick probe plate (KTP) made of CEM-1 or FR4
- Single-sided, single-stage or dual-stage contacting
- Dual-stage contacting with electrically operated shifting plate

**Technical specifications**

**Vacuum test fixtures**

- Maximum contact force: see table on page 90
- Parallel stroke: see table on page 90
- Outer dimensions (W x D x H):
  - VA 2040/MTS 100: approx. 620 x 532 x 153 mm
  - VA 2040/MTS 200: approx. 620 x 504 x 157 mm
  - VA 2040/MTS 300: approx. 645 x 532 x 181 mm
  - VA 2140/MTS 300: approx. 645 x 532 x 190 mm
  - VA 2601-2e/MTS 300: approx. 645 x 532 x 183 mm
- Usable area (W x D):
  - VA 2040: approx. 435 x 330 mm
  - VA 2140: approx. 2x 175 x 340 mm
  - VA 2601-2e: approx. 385 x 290 mm
- GKS installation height, bottom: 16.0 mm
- GKS installation height, 2-stage, bottom: 16.0 | 21.5 mm
- GKS theoretical working stroke: 4.0 mm (bottom)
- Operating temperature range: + 10 °C to + 60 °C

**Test system interface**

- MTS 100: max. 24 VG multipoint connectors (32 pole), not included
- MTS 200: max. 1,918 KT-158 (bore Ø 1.1 mm), not included
- MTS 300: max. 4,352 (3,488 signals + 864 GND) KT-158 (bore Ø 1.1 mm) not included

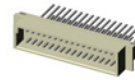



**Ordering information**

Vacuum stand-alone test fixture		
Single-stage contacting (ICT/FCT stand-alone)		
Part no.: 10932	VA 2040/D/H/MTS 100	KTP made of FR4, incl. unloaded interface
Part no.: 4758	VA 2040/D/H/MTS 200	KTP made of CEM-1, incl. unloaded interface
Part no.: 18000	VA 2040/D/H/MTS 300	KTP made of CEM-1, incl. unloaded interface
Part no.: 21629	VA 2140/D/H/MTS 300	Tandem, KTP made of CEM-1, incl. unloaded interface
Dual-stage contacting (ICT/FCT combined)		
Part no.: 18510	VA 2601-2e/D/H/MTS 300	KTP made of FR4, incl. unloaded interface, incl. electric drive
Accessories		
Part no.: 13001	VG-M-032-ac-WW-G13-Q	VG male connector (32 pole a/c) for test system interface MTS 100

Series: Customisation accessories

Compatible test fixture: VA unloaded interface  
DIGITALTEST test systems

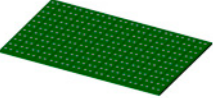
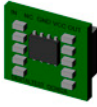
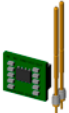
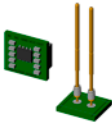
## Opens test components (OTE/OTC/OTU)

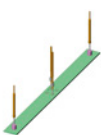
	Part number	Description	Version	Compatible with
	GKS-925 TJ A 1000-S	Spring-loaded test probe	Floating bearing, spring force: 1 N	Open check Connector check
	18747	OTC-DT-OC-SP-163-102	Sensor plate 163 x 102 mm (individually cut to size)	
	18746	OTC-DT-OC-EP	Electronics plate (OCH02)	
	54770	OTC-DT-OC-EP-GKS	Electronics plate (OCH02) incl. 2x GKS-925 TJ A 1000-S	
	18748	OTU-DT-OC-160-100	Electronics plate (OCH02) incl. sensor plate and 2x GKS-925 TJ A 1000-S	
	54772	OTC-DT-OC-SP-032-032-GKS	Open check 1.2 complete incl. sensor plate 1.2 and 2x GKS-925 TJ A 1000-S	
	54771	OTC-DT-OC-SP-155-013-GKS	Connector check complete incl. sensor plate CC, 2x GKS-925 TJ A 1000-S and 2x spring-loaded support probe GKS-102 250 400 P 1502 W	

## Installation version

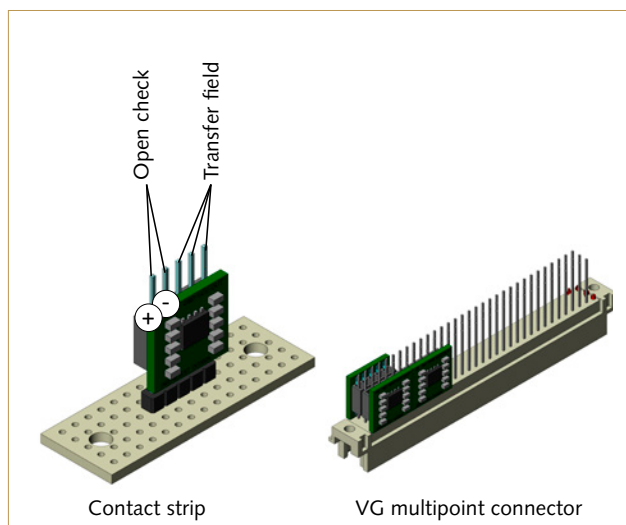

**Note:**

See page 108 to find the recommended receptacles to determine the installation height of open test components.

# Sealed with **EXCELLENCE.**

Individual functionality for particularly challenging test requirements. All **accessories** are suitable for use with all versions in INGUN's test fixture series:

- Lifting units
- Marking units
- Interface blocks
- Side approach mechanism
- Push rods

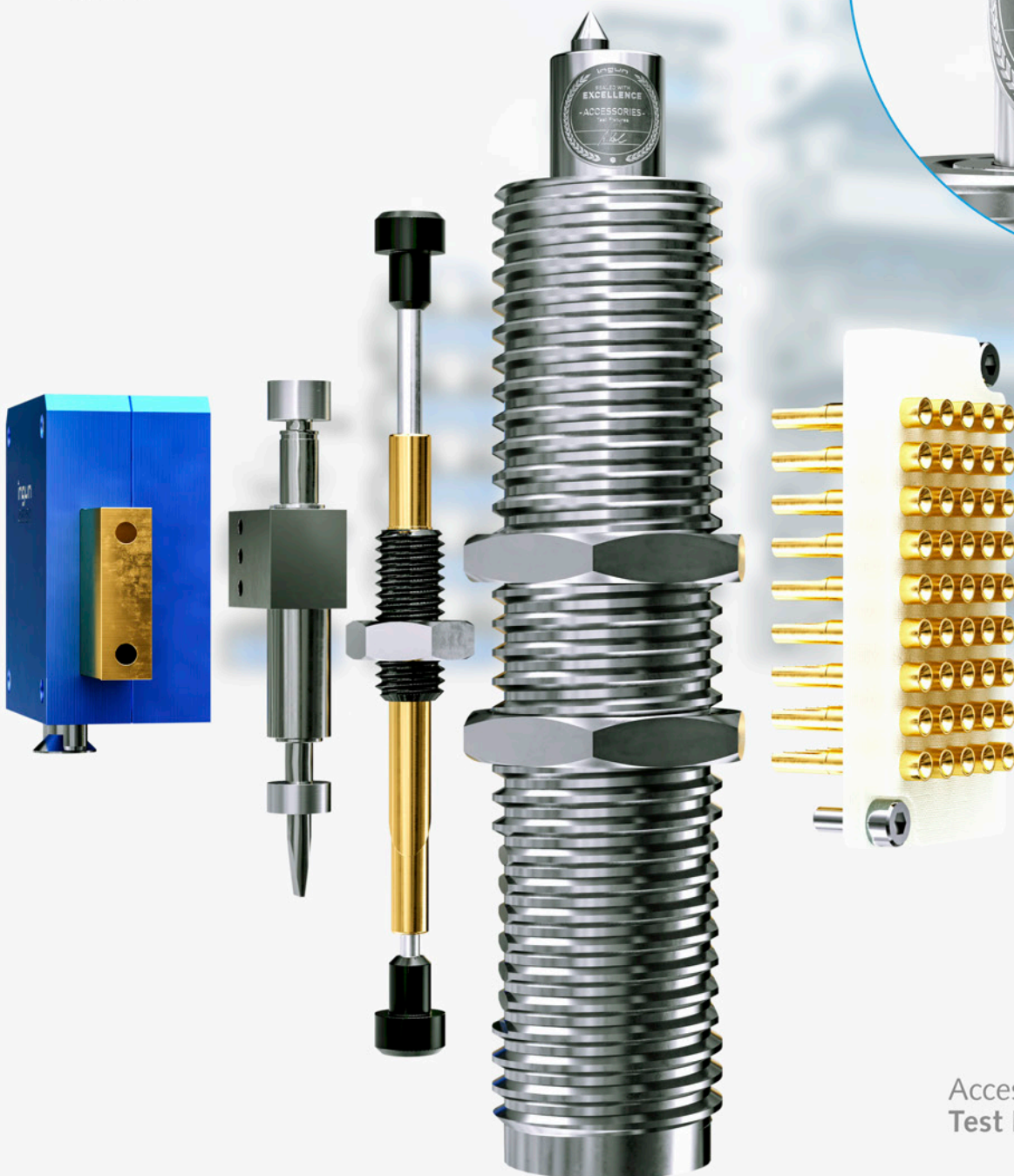

Accessories  
Test Fixtures

[www.ingun.com](http://www.ingun.com)



# Vacuum test fixtures

## Unloaded interface KEYSIGHT test systems

VA 2070S, VA 2070SR, VA 2073L test fixture for test system i3070 (offline)

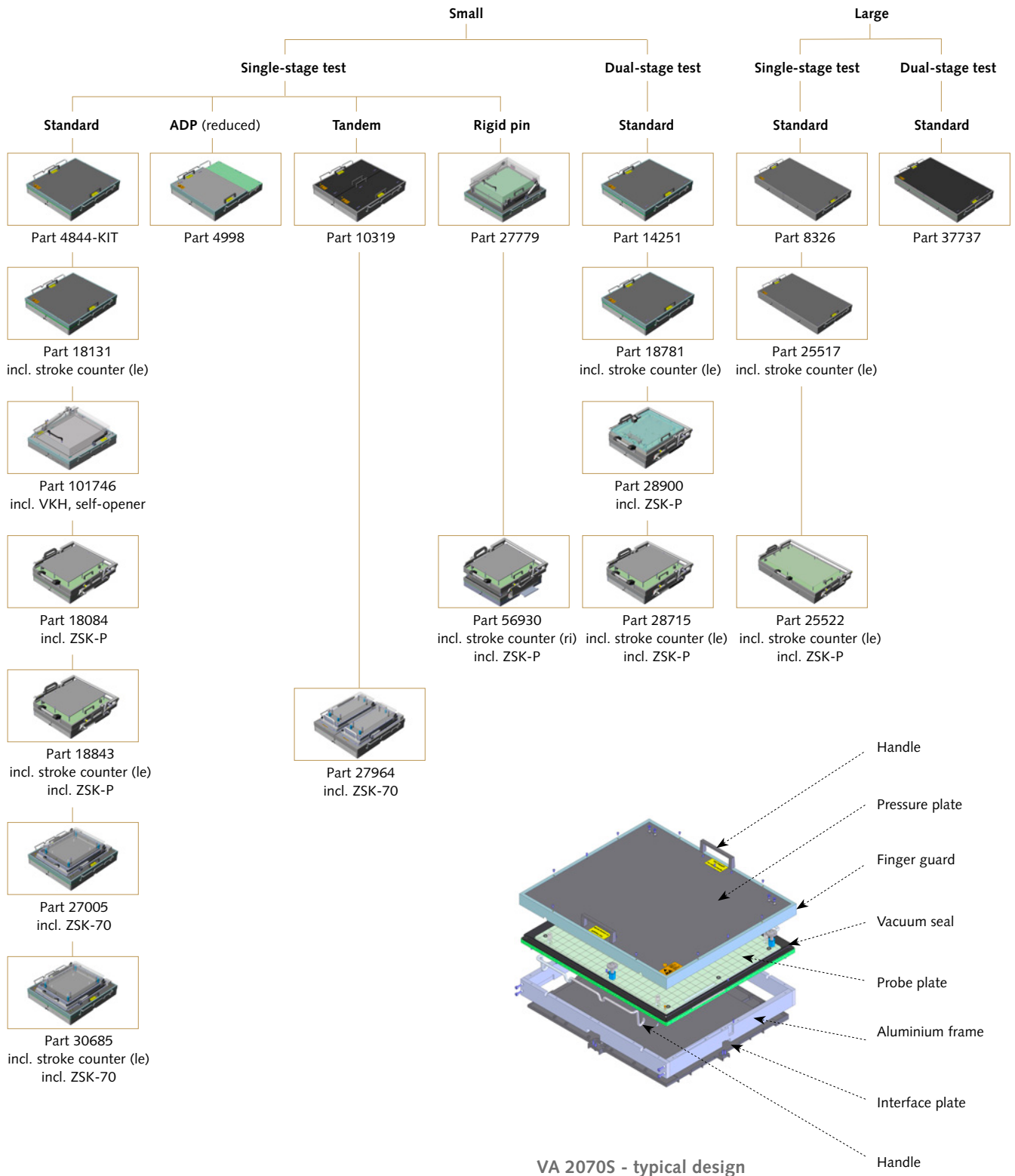



**Design versions**

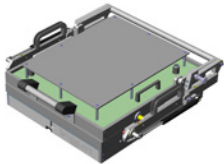

Additional contact unit  
ZSK-P

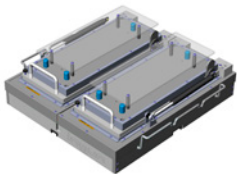

Additional contact unit  
ZSK-70

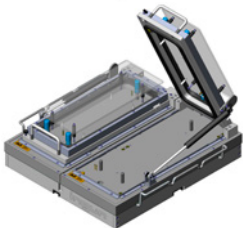

Vacuum cover  
VKH

**Usage**

Vacuum test fixtures (VA) for Keysight test systems are suitable for contacting high-volume electronic units such as printed circuit boards (PCBs) (mass testing) and a small number of versions.

The vacuum test fixtures are designed as a stand-alone system with no removable exchangeable kit, and are connected to an existing Keysight test system from the i3070 series. They are available in small and large sizes. Depending on the version, they have a pre-assembled stroke counter, a vacuum cover, or an additional contact unit, and can be used for single-sided, double-sided or dual-stage contacting.

**Features**

- Robust design
- Compatible with test system i3070 (offline)
- Stand-alone system without interchangeable replacement kit
- Available in small and large sizes
- Available with or without pre-assembled stroke counter, additional contact, or vacuum cover
- With test system interface
- Can be used for unloaded interface single-sided, both-sided or dual-stage-contacting

**Technical information for each design version**

	Pressure frame	Vacuum hood	Additional contact unit	
			ZSK-P	ZSK-70
<b>Usable area VA 2070S (mm)</b>	305 x 340	305 x 350	280 x 350	189 x 290
	single-stage version			
<b>Usable area VA 2070S (mm)</b>	260 x 330	270 x 335	270 x 330	-
	dual-stage version			
<b>Pushrod length (mm)</b>	55.6		15	15 (8.4 counter sunk)
<b>Free height above PCB (mm)</b>	53.6		13	4.6
<b>GKS Installation height, top (mm)</b>	-		16.0	10.5

(Entries in mm)

**Accessories**

Pushrods, PCB support pins, tooling pins, pre-centring pins and other accessories, such as marking units and test plugs, can be found from page 153 onwards.

**Vacuum test fixture for test system series i3070**

**Small size**

VA 2070S	102
VA 2070S/HZL	102
VA 2070S/VKH/SOP	102
VA 2070S/ZSK-P	102
VA 2070S/HZL/ZSK-P	102
VA 2070S/ZSK-70	102
VA 2070S/HZL/ZSK-70	102
VA 2070SR	103
VA 2070ST	103
VA 2070ST/ZSK-70	103
VA 2070S/VKH/SN	103
VA 2070S/HZR/ZSK-P/SN	103
VA 2070S-2e	104
VA 2070S-2e/HZL	104
VA 2070S-2e/HZL/ZSK-P	104
VA 2070S-2e/ZSK-P-2e	104

**Large size**

VA 2073L	105
VA 2073L/HZL	105
VA 2073L/HZL/ZSK-P	105
VA 2073L-2e	105

**Accessories**

SSP	106
PP	106
GKS	106
NDH - TestJet/VTEP	106
OTE - TestJet/VTEP	106
OTC/OTU - TestJet/VTEP	107
OTC/OTU - PolarityCheck	108
KS	108

## Test system interface i3070 (offline)

### Contacting single-sided, single-stage (bottom)

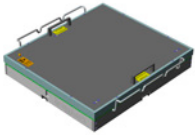

VA 2070S/i3070-5

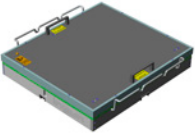

VA 2070S/HZL/i3070-5

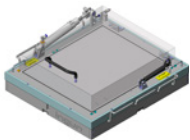

VA 2070S/VKH/SOP/i3070-5

- Incl. stroke counter (mounted on left side)

- Self-opener version
- Incl. vacuum cover without quick lock
- Incl. pneumatic self-opener

### Contacting double-sided, single-stage (bottom/top)



VA 2070S/ZSK-P/i3070-5



VA 2070S/HZL/ZSK-P/i3070-5

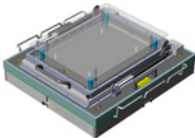

VA 2070S/ZSK-70/i3070-5

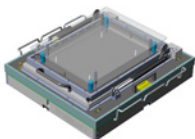

VA 2070S/HZL/ZSK-70/i3070-5

- Incl. swivelling additional contacting unit (ZSK-P)

- Incl. stroke counter (mounted on left side)
- Incl. swivelling additional contacting unit (ZSK-P)

- Incl. hinged additional contacting unit (ZSK-70)

- Incl. stroke counter (mounted on left side)
- Incl. hinged additional contacting unit (ZSK-70)

## Features

- Standard version with test system interface
- 14 mm thick probe plate (KTP) made of FR4
- Housing (aluminium frame), not hinged
- Single-sided, double-sided, single-stage contacting

## Technical specifications

### Vacuum test fixtures

- Maximum contact force: see table on page 90
- Parallel stroke: see table on page 90
- Outer dimensions, closed (W x D x H):
  - VA 2070S: approx. 465 x 460 x 100 mm
  - VA 2070S/VKH/SOP: approx. 465 x 482 x 186 mm
  - VA 2070S/ZSK-P: approx. 567 x 539 x 165 mm
  - VA 2070S/ZSK-70: approx. 465 x 460 x 151 mm
- Usable area (W x D):
  - VA 2070S: approx. 305 x 380 mm
  - VA 2070S/VKH/SOP: approx. 300 x 350 mm
  - VA 2070S/ZSK-P: approx. 280 x 350 mm
  - VA 2070S/ZSK-70: approx. 189 x 290 mm
- Sample position (row/column):
  - VA 2070S: 1.5/22.5 - 00/78
  - VA 2070S/VKH/SOP: 02/22 - 05/75
  - VA 2070S/ZSK-P: 02/22 - 05/75
  - VA 2070S/ZSK-70: 04/22 - 10/68
- Pressure frame unit opening angle:
  - VA 2070S/VKH/SOP: approx. 65 ° parallel open (front, insertion length approx. 150 mm)
  - VA 2070S/ZSK-P: approx. 85 °
  - VA 2070S/ZSK-70: 16.0 mm
- GKS installation height, bottom: 4.0 mm (bottom)
- GKS theoretical working stroke: + 10 °C to + 60 °C
- Operating temperature range: + 10 °C to + 60 °C

### Test system interface

- i3070 - Small (offline): max. 3,666 personality pins, not included

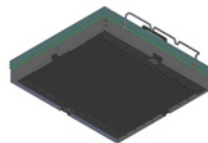

(see page 106)

## Ordering information

Vacuum stand-alone test fixture		
Single-stage contacting (ICT/FCT stand-alone)		
Part no.: 4844-KIT	VA 2070S/i3070-5	
Part no.: 18131	VA 2070S/HZL/i3070-5	Incl. stroke counter
Part no.: 101746	VA 2070S/VKH/SOP/i3070-5	Incl. vacuum cover, pneumatic self-opener
Part no.: 18084	VA 2070S/ZSK-P/i3070-5	Incl. swivelling additional contact (ZSK-P)
Part no.: 18843	VA 2070S/HZL/ZSK-P/i3070-5	Incl. stroke counter, swivelling additional contact (ZSK-P)
Part no.: 27005	VA 2070S/ZSK-70/i3070-5	Incl. hinged additional contact (ZSK-70)
Part no.: 30685	VA 2070S/HZL/ZSK-70/i3070-5	Incl. stroke counter, hinged additional contact (ZSK-70)

Parts with the ending "-KIT" are delivered unassembled. This enables immediate DUT-specific processing.

**Test system interface i3070 (offline)**

**Contacting single-sided, single-stage (bottom)**

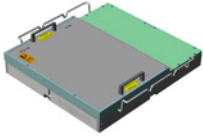

- Pressure plate reduced
- Assembly of additional hardware on KTP possible

VA 2070SR/i3070-5

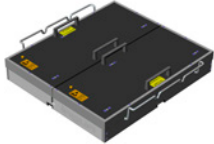

- Tandem version

VA 2070ST/i3070-5

**Contacting double-sided, single-stage (bottom/top)**

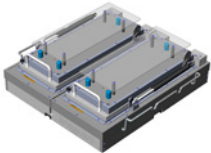

- Tandem version
- Incl. 2x hinged additional contacting unit (ZSK-70)

VA 2070ST/ZSK-70/i3070-5

**Contacting single-sided, single-stage (bottom)**

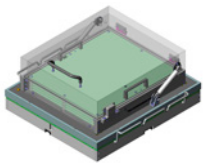

- Rigid pin version
- Incl. vacuum cover with quick lock, 13 N retention force

VA 2070S/VKH/SN/i3070-5

**Contacting double-sided, single-stage (bottom/top)**

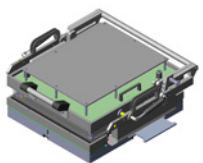

- Rigid pin version
- Incl. stroke counter (mounted on right side)
- Incl. swivelling additional contacting (ZSK-P)

VA 2070S/HZR/ZSK-P/SN/i3070-5

**Features**

- Version with pressure plate reduced, tandem or rigid pin
- 14 mm thick probe plate (KTP) made of FR4
- Housing (aluminium frame) not hinged
- Single-sided, double-sided, single-stage contacting

**Technical specifications**

**Vacuum test fixtures**

- Maximum contact force: see table on page 90
- Parallel stroke: see table on page 90
- Outer dimensions, closed (W x D x H):
  - VA 2070SR | VA 2070ST: approx. 465 x 460 x 100 mm
  - VA 2070ST/ZSK-70: approx. 465 x 460 x 151 mm
  - VA 2070S/VKH/SN: approx. 465 x 460 x 236 mm
  - VA 2070S/HZR/ZSK-P: approx. 640 x 539 x 216 mm
- Usable area (W x D):
  - VA 2070SR: approx. 305 x 230 mm
  - VA 2070ST: approx. 2x 100 x 380 mm
  - VA 2070ST/ZSK-70: approx. 2x 100 x 260 mm
  - VA 2070S/SN (sample size): approx. 275 x 325 mm
  - VA 2070S/SN (test area): approx. 260 x 310 mm
- Sample position (row/column):
  - VA 2070SR: 10/22 - 00/80
  - VA 2070ST: 1.5/22.5 - 01/27 | 53/78
  - VA 2070ST/ZSK-70: 04/20 - 05/26 | 53/78
  - VA 2070S/SN: 02/22 - 05/75
- Pressure frame unit opening angle:
  - VA 2070ST/ZSK-70: approx. 85 °
  - VA 2070S/VKH: approx. 85 °
  - VA 2070S/HZR/ZSK-P: parallel open (front, insertion length approx. 150 mm)
- GKS installation height, bottom: 16.0 mm
- GKS theoretical working stroke: 4.0 mm (bottom)
- Operating temperature range: + 10 °C to + 60 °C

**Test system interface**

- i3070 Small (offline) max. 3,666 personality pins, not included

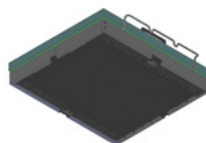

(see page 106)

**Note:**

Further information about rigid pin customisation can be found from page 93 onwards.

**Ordering information**

Vacuum stand-alone test fixture		
Single-stage contacting (ICT/FCT stand-alone)		
Part no.: 4998	VA 2070SR/i3070-5	Pressure plate reduced, assembly of add. hardware on KTP possible
Part no.: 10319	VA 2070ST/i3070-5	Tandem
Part no.: 27964	VA 2070ST/ZSK-70/i3070-5	Tandem, incl. 2x hinged additional contact (ZSK-70)
Part no.: 27779	VA 2070S/VKH/SN/i3070-5	Rigid pin, incl. vacuum cover
Part no.: 56930	VA 2070S/HZR/ZSK-P/SN/i3070-5	Rigid pin, incl. stroke counter, swivelling, add. contact unit (ZSK-P)

## Test system interface i3070 (offline)

### Contacting single-sided, dual-stage (bottom)

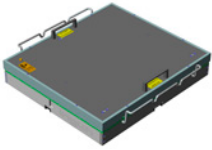

VA 2070S-2e/i3070-5

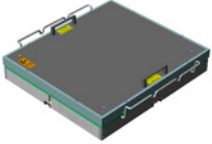

- Incl. stroke counter (mounted on left side)

VA 2070S-2e/HZL/i3070-5

### Contacting double-sided, dual-stage (bottom) / single-sided, single-stage (top)

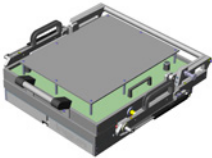

- Incl. stroke counter (mounted on left side)
- Incl. swivelling additional contacting unit (ZSK-P)

VA 2070S-2e/HZL/ZSK-P/i3070-5

### Contacting double-sided, dual-stage (bottom) / dual-stage (top)

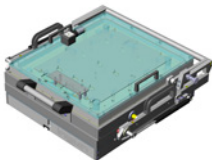

- Incl. swivelling additional contacting unit (ZSK-P)

VA 2070S-2e/ZSK-P-2e/i3070-5

## Features

- Standard version with test system interface
- 14 mm thick probe plate (KTP) made of FR4
- Housing (aluminium frame), not hinged
- Single-sided, double-sided, dual-stage contacting
- Dual-stage contacting with electrically operated shifting plate

## Technical specifications

### Vacuum test fixtures

- Maximum contact force: see table on page 90
- Parallel stroke: see table on page 90
- Outer dimensions, closed (W x D x H):
  - VA 2070S-2e: approx. 465 x 460 x 105 mm
  - VA 2070S-2e/ZSK-P: approx. 567 x 539 x 165 mm
  - VA 2070S-2e/ZSK-P-2e: approx. 567 x 539 x 185 mm
- Usable area (W x D):
  - VA 2070S-2e: approx. 270 x 335 mm
  - VA 2070S-2e/ZSK-P: approx. 270 x 330 mm
  - VA 2070S-2e/ZSK-P-2e: approx. 270 x 310 mm
- Sample position (row/column):
  - VA 2070S-2e: 3/21 - 00/75
  - VA 2070S-2e/ZSK-P: 2.5/20 - 05/75
  - VA 2070S-2e/ZSK-P-2e: 04/20 - 04/75
- Pressure frame unit opening angle:
  - VA 2070S/ZSK-P: parallel open (front, insertion length approx. 150 mm)
- GKS installation height, bottom: 16.0 mm
- GKS installation height, 2-stage, bottom: 16.0 | 21.5 mm
- GKS theoretical working stroke: 4.0 mm (bottom)
- Operating temperature range: + 10 °C to + 60 °C

### Test system interface

- i3070 - Small (offline): max. 3,666 personality pins, not included

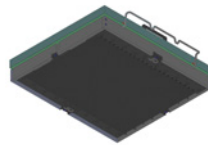

(see page 106)

## Ordering information

Vacuum stand-alone test fixture		
Dual-stage contacting (ICT/FCT combined)		
Part no.:	14251	VA 2070S-2e/i3070-5
Part no.:	18781	VA 2070S-2e/HZL/i3070-5
		Incl. stroke counter
Part no.:	28715	VA 2070S-2e/HZL/ZSK-P/i3070-5
		Incl. stroke counter, swivelling additional contact unit (ZSK-P)
Part no.:	28900	VA 2070S-2e/ZSK-P-2e/i3070-5
		Incl. swivelling additional contact unit (ZSK-P)

**Test system interface i3070 (offline)**

**Contacting single-sided single-stage (bottom)**



VA 2073L/i3070-5



VA 2073L/HZL/i3070-5

- Incl. stroke counter (mounted on left side)

**Contacting double-sided, single-stage (bottom/top)**

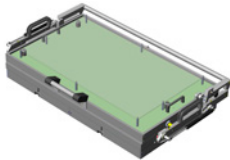

VA 2073L/HZL/ZSK-P/i3070-5

- Incl. stroke counter (mounted on left side)
- Incl. swivelling additional contacting unit (ZSK-P)

**Contacting single-sided, dual-stage (bottom)**

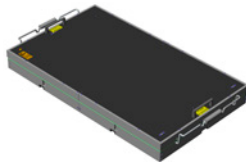

VA 2073L-2e/i3070-5

**Features**

- Standard version with test system interface
- 14 mm thick probe plate (KTP) made of FR4
- Housing (aluminium frame) not hinged
- Single-sided single or dual-stage or double-sided, single-stage contacting
- Dual-stage contacting with electrically operated shifting plate

**Technical specifications**

**Vacuum test fixtures**

- Maximum contact force: see table on page 90
- Parallel stroke: see table on page 90
- Outer dimensions, closed (W x D x H):
  - VA 2073L: approx. 827 x 460 x 100 mm
  - VA 2073L/ZSK-P: approx. 928 x 539 x 163 mm
  - VA 2073L-2e: approx. 838 x 460 x 105 mm
- Usable area (W x D):
  - VA 2073L: approx. 670 x 380 mm
  - VA 2073L/ZSK-P: approx. 630 x 350 mm
  - VA 2073L-2e: approx. 650 x 335 mm
- Sample position (row/column):
  - VA 2073L: 2/22 - 00/75
  - VA 2073L/ZSK-P: 2/22 - 05/65
  - VA 2073L-2e: 2/22 - 05/70
- Pressure frame unit opening angle:
  - VA 2073L/ZSK-P: parallel open (front, insertion length approx. 150 mm)
- GKS installation height, bottom: 16.0 mm
- GKS theoretical working stroke: 4.0 mm (bottom)
- Operating temperature range: + 10 °C to + 60 °C

**Test system interface**

- i3070-Large (offline): max. 7,332 personality pins, not included



(see page 106)

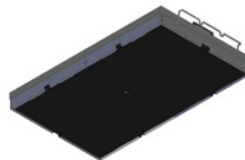

**Ordering information**



Vacuum stand-alone test fixture		
Single-stage contacting (ICT/FCT stand-alone)		
Part no.:	8326	VA 2073L/i3070-5
Part no.:	25517	VA 2073L/HZL/i3070-5
		Incl. stroke counter
Part no.:	25522	VA 2073L/HZL/ZSK-P/i3070-5
		Incl. stroke counter, swivelling additional contact unit (ZSK-P)
Dual-stage contacting (ICT/FCT combined)		
Part no.:	37737	VA 2073L-2e/i3070-5
		Contacting single-sided dual-stage (bottom)

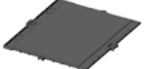
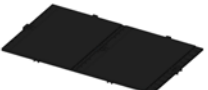

### Interface plate (SSP)

	Part number	Description	Version	Compatible with
	14671	Interface plate E3980A-FG	Small	VA 2070S
	14683	Interface plate E3981A-FG	Large	VA 2073L

### Personality pins (PP)

	Part number	Description	Version	Compatible with
	44081	PP-INGUN-S	Wire-wrap post: - Sharp head - Completely gold-plated	- VA 2070S - VA 2073L
	45000	PP-INGUN-F	Wire-wrap post: - Flat head - Completely gold-plated	

### Test system interface contact (GKS)

	Part number	Description	Version	Compatible with
	GKS-100 306 229 A 1000	Spring-loaded test probe	Spring force: 1 N	Test system interface Keysight i3070-X

### TestJet/VTEP Pressure frame units (NDH) for assembly on pressure plate

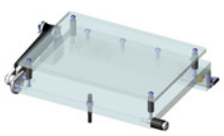
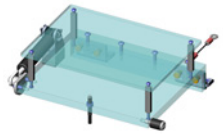



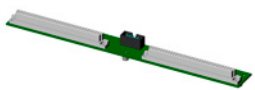
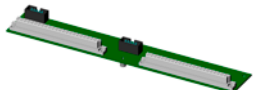
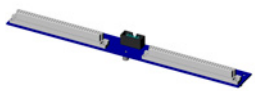
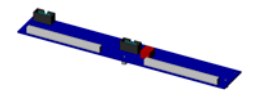

	Part number	Description	Version	Compatible with
	15266	NDH-180-150-TestJet	Standard for approx. 10 TestJets Usable area: approx. 170 x 130 mm Outer dim. (WxHxD): 229x176x63 mm	- VA 2070S - VA 2073L
	15241	NDH-250-210-TestJet	Standard for approx. 25 TestJets Usable area: approx. 240 x 190 mm Outer dim. (WxHxD): 280x236x78 mm	
	39447	NDH-180-150-TestJet-ESD	ESD for approx. 10 TestJets Usable area: approx. 170 x 130 mm Outer dim. (WxHxD): 229x176x78 mm	
	39696	NDH-250-210-TestJet-ESD	ESD for approx. 25 TestJets Usable area: approx. 240 x 190 mm Outer dim. (WxHxD): 299x236x78 mm	

### TestJet/VTEP control electronics (OTE) unloaded interface Opens Test components (MUX boards)

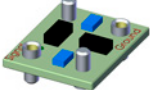
	Part number	Description	Version	Compatible with
	9681	OTE-KS-TJ-064-MUX E3849A-FG	Signal Conditioner Board TestJet (2x 64 contacts)	- TestJet - Polarity Check TestJet
	14038	OTE-KS-TJ-064-MUX-REF E3969A-FG	Signal Conditioner Board TestJet/ConnectCheck (2x 46 contacts)	
	23777	OTE-KS-VT-064-MUX N4300A-FG	Signal Conditioner Board VTEP (2x 64 contacts)	- VTEP - Polarity Check VTEP
	60891	OTE-KS-VT-064-MUX-REF N4307A-FG	Signal Conditioner Board VTEP/ConnectCheck (2x 46 contacts)	

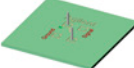

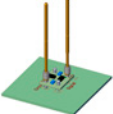
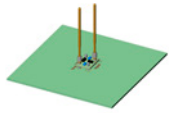
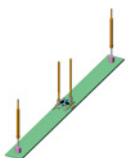
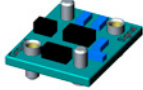

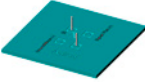
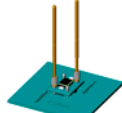
Series: Customisation accessories  
 Compatible test fixture: VA 2070S | VA 2073L

### TestJet/VTEP Opens test components (OTC/OTU)

	Part number	Description	Version	Compatible with
	GKS-925 TJ A 1000-S	Spring-loaded test probe	Floating bearing, spring force: 1 N	- TestJet - VTEP
	9682	OTC-KS-TJ-EP	Electronics plate	TestJet
	17031	OTC-KS-TJ-EP-GKS	Electronics plate incl. 2x GKS-925 TJ A 1000-S	
	9683	OTC-KS-TJ-SP-032-032	Sensor plate 1.2 Area: 31.8 x 31.8 mm	
	9686	OTC-KS-TJ-SP-065-065	Sensor plate 2.5 Area: 65.1 x 65.1 mm	
	12175	OTC-KS-TJ-SP-155-013	Sensor plate ConnectorTest Area: 12.8 x 155 mm	
	54779	OTU-KS-TJ-032-032	TestJet 1.2 incl. electronics plate and 2x GKS-925 TJ A 1000-S	
	54780	OTU-KS-TJ-065-065	TestJet 2.5 incl. electronics plate and 2x GKS-925 TJ A 1000-S	
	54781	OTU-KS-TJ-155-013	TestJet ConnectorTest incl. electronics plate and 2x GKS-925 TJ A 1000-S and 2x spring-loaded support probe GKS-102 250 400 P 1502 W	
	23778	OTC-KS-VT-EP	Electronics plate	
	24956	OTC-KS-VT-EP-GKS	Electronics plate incl. 2x GKS-925 TJ A 1000-S	
	23779	OTC-KS-VT-SP-032-032	Sensor plate 1.2 Area: 31,8 x 31,8 mm	
	23780	OTC-KS-VT-SP-065-065	Sensor plate 2.5 Area: 65,1 x 65,1 mm	
	60890	OTC-KS-VT-SP-155-013	Sensor plate ConnectorTest Area: 12,8 x 155 mm	
	54784	OTU-KS-VT-032-032	VTEP 1.2 incl. electronics plate and 2x GKS-925 TJ A 1000-S	

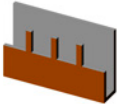
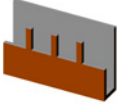
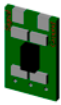
VA with Test system interface

## Polarity Check TestJet/VTEP Opens test components (OTC/OTU)

	Part number	Description	Version	Compatible with
	12314	OTC-KS-TJ-PC-GKS Spring-loaded test probe	Spring force: 1 N	Polarity Check TestJet/VTEP
	12315	OTC-KS-TJ-PC-SP-007-004	Sensor plate B/C - Size Area: 6.5 x 3.8 mm	
	12316	OTC-KS-TJ-PC-SP-008-005	Sensor plate D - Size Area: 7.6 x 4.9 mm	
	12313	OTC-KS-TJ-PC-EP	Electronics plate	Polarity Check TestJet
	54783	OTU-KS-TJ-PC-007-004	Polarity Check B/C - Size incl. electronics plate and 2x OTC-KS-TJ-PC-GKS	
	54782	OTU-KS-TJ-PC-008-005	Polarity Check D - Size incl. electronics plate and 2x OTC-KS-TJ-PC-GKS	
	23783	OTC-KS-VT-PC-EP	Electronics plate	Polarity Check VTEP
	54785	OTU-KS-VT-PC-008-005	Polarity Check D - Size incl. electronics plate and 2x OTC-KS-TJ-PC-GKS	

## Recommended receptacles (KS), unloaded interface Opens Test components to determine the installation height

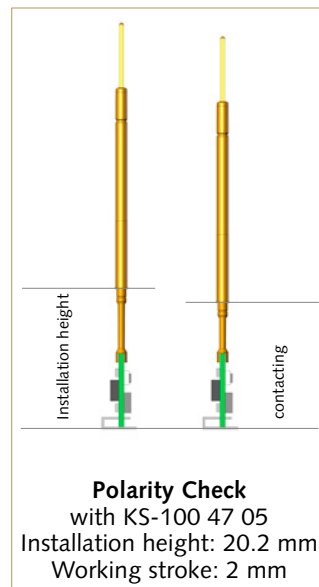
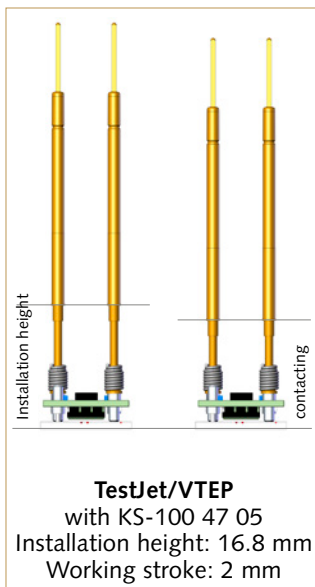

Receptacle (KS)	Installation height	
	TestJet/VTEP	Polarity Check
KS-100 47 05	16.8 mm	20.2 mm
KS-100 47 25	18.6 mm	22.2 mm
KS-100 47 40	20.1 mm	23.7 mm
KS-100 47	22.1 mm	25.2 mm
KS-100 47 G	23.6 mm	27.2 mm
KS-100 47 G 12	27.1 mm	30.7 mm

Contacting: Single/Dual-stage (ICT/FCT stand-alone | combined)

**Test system interface RH-VG**

**Contacting single-sided, single-stage (bottom)**

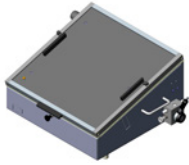

VA 2035/D/H/RH

- Probe plate (KTP) made of CEM-1
- 1x VA connection with  $\varnothing = 32$  mm on the left on housing
- Unloaded interface for 18 VG multi-point connectors (64 | 96-pole)

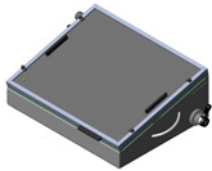

VA 2040/D/H/RH

- Probe plate (KTP) made of FR4
- 1x VA connection with  $\varnothing = 32$  mm on the left on housing
- Unloaded interface for 18 VG multi-point connectors (64 | 96-pole)

**Contacting single-sided, dual-stage (bottom)**

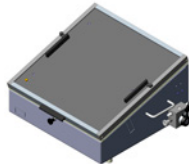

VA 2035-2e/D/H/RH

- Probe plate (KTP) made of CEM-1
- 1x VA connection PG16 on the back panel
- Unloaded interface for 16 VG multi-point connectors (64 | 96-pole)
- Incl. electric drive

**Features**

- Standard version with test system interface
- 10 mm thick probe plate (KTP) made of CEM-1 or FR4
- Single-sided single-stage or dual-stage contacting
- Dual-stage contacting with electrically operated shifting plate

**Technical specifications**

**Vacuum test fixtures**

- Maximum contact force: see table on page 90
- Parallel stroke: see table on page 90
- Outer dimensions, closed (W x D x H):
  - VA 2035/RH: approx. 578 x 435 x 247 mm
  - VA 2040/RH: approx. 700 x 476 x 215 mm
  - VA 2035-2e/RH: approx. 578 x 435 x 251 mm
- Usable area (W x D):
  - VA 2035/RH: approx. 305 x 305 mm
  - VA 2040/RH: approx. 435 x 330 mm
  - VA 2035-2e/RH: approx. 265 x 265 mm
- GKS installation height, bottom: 16.0 mm
- GKS installation height, 2-stage, bottom: 16.0 | 21.5 mm
- GKS theoretical working stroke: 4.0 mm (bottom)
- Operating temperature range: + 10 °C to + 60 °C

**Test system interface**

- VA 2035/RH: max. 18 VG multipoint connectors (64 | 96-pole) for 1,152 | 1,728 signals, not included

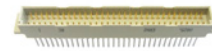

- VA 2040/RH: max. 18 VG multipoint connectors (64 | 96-pole) for 1,152 | 1,728 signals, not included

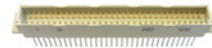
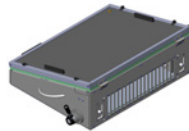

- VA 2035-2e/RH: max. 16 VG multipoint connectors (64 | 96-pole) for 1,042 | 1,536 signals, not included

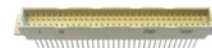
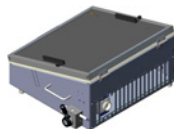

**Note:**

See wiring of VG female socket connectors (64/96-pole) for unloaded interface on page 205.

**Ordering information**

Vacuum stand-alone test fixture		
Single-stage contacting (ICT/FCT stand-alone)		
Part no.:	17293	VA 2035/D/H/RH
		KTP made of CEM-1, 1x VA connection on left side of housing
Part no.:	12421	VA 2040/D/H/RH
		KTP made of FR4, 1x VA connection on left side of housing
Dual-stage contacting (ICT/FCT combined)		
Part no.:	34834	VA 2035-2e/D/H/RH
		KTP made of CEM-1, 1x VA connection to back panel, incl. electric drive
Accessories		
Part no.:	11438	VG-M-064-ac-WW-G13-Q
		VG male multipoint connector (64 pole a/c) for test system interface
Part no.:	17962	VG-M-096-abc-WW-G13-Q
		VG male multipoint connector (96 pole a/b/c) test system interface

## Test system interface SPEA 501

### Contacting single-sided **single-stage** (bottom)

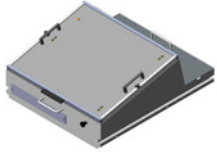

VA 2020/D/H/SPEA 501

- Probe plate (KTP) made of CEM-1
- Without interface, for 54 pin multipoint connectors 2x 36 pole

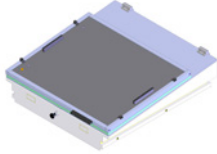

VA 2040/D/H/SPEA 501

- Probe plate (KTP) made of FR4
- Incl. unloaded interface for 54 pin multipoint connectors 2x 36 pole

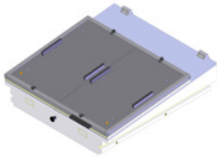

VA 2140/D/H/SPEA 501

- Tandem version
- Probe plate (KTP) made of CEM-1
- Incl. unloaded interface for 54 pin multipoint connectors 2x 36 pole

### Contacting single-sided, **dual-stage** (bottom)

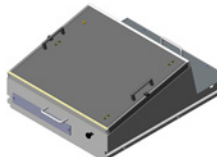

VA 2020-2e/D/H/SPEA 501

- Probe plate (KTP) made of CEM-1
- Incl. unloaded interface for 54 pin multipoint connectors 2x 36 pole
- Without electric drive

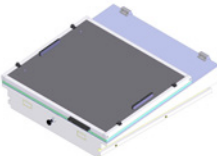

VA 2601-2e/D/H/SPEA 501

- Probe plate (KTP) made of FR4
- Incl. unloaded interface for 54 pin multipoint connectors 2x 36 pole
- Incl. electric drive

## Features

- Standard or tandem version with/without test system interface
- 10 mm thick probe plate (KTP) made of CEM-1 or FR4
- Cover stay for fixing the open housing
- Single-sided, single-stage or dual-stage contacting
- Dual-stage contacting with electrically operated shifting plate

## Technical specifications

### Vacuum test fixtures

- Maximum contact force: see table on page 90
- Parallel stroke: see table on page 90
- Outer dimensions, closed (W x D x H):
  - VA 2020/Spea 501: approx. 489 x 622 x 226 mm
  - VA 2040/Spea 501: approx. 550 x 625 x 175 mm
  - VA 2140/Spea 501: approx. 550 x 620 x 182 mm
  - VA 2020-2e/Spea 501: approx. 489 x 622 x 230 mm
  - VA 2601-2e/Spea 501: approx. 550 x 625 x 177 mm
- Usable area (W x D):
  - VA 2020: approx. 370 x 280 mm
  - VA 2040: approx. 435 x 330 mm
  - VA 2140: approx. 2x 175 x 340 mm
  - VA 2020-2e: approx. 330 x 260 mm
  - VA 2601-2e: approx. 385 x 290 mm
- GKS installation height, bottom: 16.0 mm
- GKS installation height, 2-stage, bottom: 16.0 | 21.5 mm
- GKS theoretical working stroke: 4.0 mm (bottom)
- Operating temperature range: + 10 °C to + 60 °C

### Test system interface

- SPEA 501: max. 54 pin multipoint connectors 2x 36 pole (max. 3,888 signals), not included

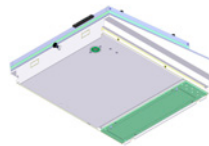

## Ordering information

Vacuum stand-alone test fixture		
Single-stage contacting (ICT/FCT stand-alone)		
Part no.:	20842	VA 2020/D/H/Spea 501
		KTP made of CEM-1, without interface
Part no.:	25338	VA 2040/D/H/Spea 501
		KTP made of FR4, incl. unloaded interface
Part no.:	35340	VA 2140/D/H/Spea 501
		Tandem, KTP made of CEM-1, incl. unloaded interface
Dual-stage contacting (ICT/FCT combined)		
Part no.:	20850	VA 2020-2e/D/H/Spea 501
		KTP made of CEM-1, without interface, without electric drive
Part no.:	44260	VA 2601-2e/D/H/Spea 501
		KTP made of FR4, incl. unloaded interface, incl. electric drive

Accessories		
Part no.:	27331	Test system interface
		Interface Spea 501 (54 slots), unloaded
Part no.:	28078	Pin strip
		Pin strip 2x 36 pole, gold-plated, unloaded interface SPEA 501
Part no.:	21729	Electric drive
		Electric drive with angular gearing unloaded interface VA 2020-2e
Part no.:	16436	Spacer plate
		Spacer plate for mounting electric drive



Series: Customisation accessories  
Compatible test fixture: VA for SPEA test systems

Opens test components (Escan)

Part number	Description	Version	Compatible with
32627	OTE-SP-ES-016-MUX ES-MPX16	Escan Multiplexer (16 channels) without case	Open Pin Check Escan Multiplexer
33512	OTC-SP-ES-EP-L300 Escan-Probe-20	Spring-loaded contact element with 4-wire cable connection and connectors unloaded interface Escan Multiplexer ES-MPX16 Height: 60 mm, cable length: 300 mm	Open Pin Check Escan-Probe
33513	OTC-SP-ES-EP-L400 Escan-Probe-30	Spring-loaded contact element with 4-wire cable connection and connectors unloaded interface Escan Multiplexer ES-MPX16 Height: 60 mm, cable length: 400 mm	
33514	OTC-SP-ES-EP-L600 Escan-Probe-40	Spring-loaded contact element with 4-wire cable connection and connectors unloaded interface Escan Multiplexer ES-MPX16 Height: 60 mm, cable length: 600 mm	
33515	OTC-SP-ES-EP-L800 Escan-Probe-50	Spring-loaded contact element with 4-wire cable connection and connectors unloaded interface Escan Multiplexer ES-MPX16 Height: 60 mm, cable length: 800 mm	
33518	OTC-SP-ES-SP-004-007 Captor10	Sensor plate (area: 4.0 x 7.0 mm)	
33519	OTC-SP-ES-SP-005-009 Captor11	Sensor plate (area: 5.0 x 9.0 mm)	
33520	OTC-SP-ES-SP-006-011 Captor12	Sensor plate (area: 5.2 x 10.4 mm)	
33521	OTC-SP-ES-SP-006-015 Captor13	Sensor plate (area: 6.0 x 14.1 mm)	
33522	OTC-SP-ES-SP-008-013 Captor14	Sensor plate (area: 7.5 x 12.9 mm)	
33523	OTC-SP-ES-SP-010-022 Captor15	Sensor plate (area: 10.0 x 21.0 mm)	
33524	OTC-SP-ES-SP-010-019 Captor16	Sensor plate (area: 10.0 x 18.4 mm)	
33525	OTC-SP-ES-SP-010-028 Captor17	Sensor plate (area: 10.0 x 27.5 mm)	
33526	OTC-SP-ES-SP-013-019 Captor18	Sensor plate (area: 12.2 x 18.4 mm)	
33527	OTC-SP-ES-SP-014-020 Captor19	Sensor plate (area: 13.8 x 19.6 mm)	
33528	OTC-SP-ES-SP-028-028 Captor20	Sensor plate (area: 27.5 x 27.5 mm)	
33529	OTC-SP-ES-SP-035-035 Captor21	Sensor plate (area: 35.0 x 35.0 mm)	
32630	OTU-SP-ES-028-028-L300 Escan-Probe 20/20	Escan-Probe-Captor Unit Escan-Probe-20 incl. Captor20	Open Pin Check Probe Unit

VA with  
Test system  
interface



Escan Multiplexer  
ES-MPX16

Escan-Probe-20

Captor18

Multiplexer + Escan-Probe  
+ Captor

## Test system interface TD Z18xx

### Contacting single-sided, **single-stage** (bottom)

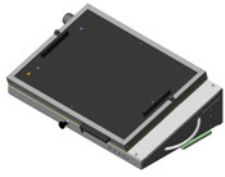

- Probe plate (KTP) made of CEM-1
- 1x VA connection with  $\varnothing = 32$  mm on left side of housing
- Incl. unloaded interface for 930x KT-158

VA 2030/D/H/TD Z1800-M/VAL

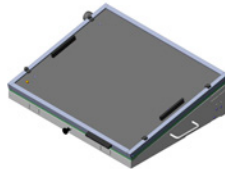

- Probe plate (KTP) made of FR4
- 1x VA connection with  $\varnothing = 32$  mm on left side of housing
- Incl. unloaded interface for 930x KT-158

VA 2040/D/H/TD Z1800-M/VAL

## Test system interface TD 88xx-M

### Contacting single-sided, **single-stage** (bottom)

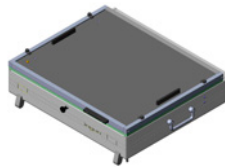

- Probe plate (KTP) made of FR4
- Incl. unloaded interface for 3,900x KT-158

VA 2040/F/H/TD 88xx-M

### Contacting single-sided, **dual-stage** (bottom)

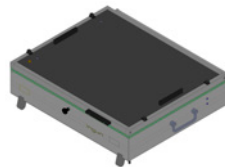

- Probe plate (KTP) made of FR4
- Incl. unloaded interface for 3,900x KT-158
- Incl. electric drive

VA 2601-2e/F/H/TD 88xx-M

## Features

- Standard version with test system interface
- 10 mm thick probe plate (KTP) made of CEM-1 or FR4
- Bow handle, drawer handle, or hinged handle as carrying handle
- Single-sided, single-stage or dual-stage contacting
- Dual-stage contacting with electrically operated shifting plate

## Technical specifications

### Vacuum test fixtures

- Maximum contact force: see table on page 90
- Parallel stroke: see table on page 90
- Outer dimensions (W x D x H):
  - VA 2030/D/H/TD Z1800-M/VAL: approx. 595 x 353 x 168 mm
  - VA 2040/D/H/TD Z1800-M/VAL: approx. 628 x 476 x 168 mm
  - VA 2040/F/H/TD 88xx-M: approx. 580 x 518 x 166 mm
  - VA 2601-2e/F/H/TD 88xx-M: approx. 580 x 518 x 171 mm
- Usable area (W x D):
  - VA 2030: approx. 345 x 215 mm
  - VA 2040: approx. 435 x 330 mm
  - VA 2601-2e: approx. 385 x 290 mm
- GKS installation height, bottom: 16.0 mm
- GKS installation height, 2-stage, bottom: 16.0 | 21.5 mm
- GKS theoretical working stroke: 4.0 mm (bottom)
- Operating temperature range: + 10 °C to + 60 °C

### Test system interface

- TD Z1800-M: max. 930 KT-158 (bore  $\varnothing$  1.1 mm), not included

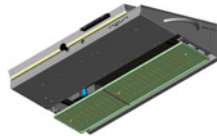

(see page 211)

- TD 88xx-M: max. 3,900 KT-158 (bore  $\varnothing$  1.1 mm), not included

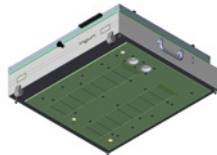

(see page 211)

## Ordering information

Vacuum stand-alone test fixture		
Single-stage contacting (ICT/FCT stand-alone)		
Part no.:	13516	VA 2030/D/H/TD Z1800-M/VAL
		KTP made of CEM-1, bow handle, VA connect. $\varnothing = 32$ mm, incl. interface
Part no.:	13517	VA 2040/D/H/TD Z1800-M/VAL
		KTP made of FR4, drawer handle, VA connect. $\varnothing = 32$ mm, incl. interface
Part no.:	14420	VA 2040/F/H/TD 88xx-M
		KTP made of FR4, hinged handle, incl. interface
Dual-stage contacting (ICT/FCT combined)		
Part no.:	13898	VA 2601-2e/F/H/TD 88xx-M
		KTP made of FR4, hinged handle, incl. electric drive, incl. interface

**Test system interface TD 88xx-S**

**Contacting single-sided, single-stage (bottom)**

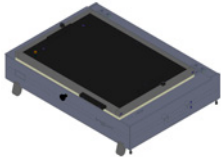

- Probe plate (KTP) made of CEM-1
- Incl. unloaded interface for 1,950x KT-158

VA 2030/F/H/TD 88xx-S

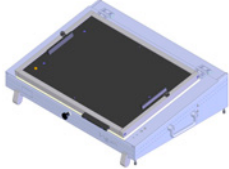

- Probe plate (KTP) made of CEM-1
- Incl. unloaded interface for 1,950x KT-158

VA 2030/D/H/TD 88xx-S

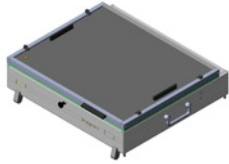

- Probe plate (KTP) made of FR4
- Incl. unloaded interface for 1,950x KT-158

VA 2040/F/H/TD 88xx-S

**Contacting single-sided, dual-stage (bottom)**

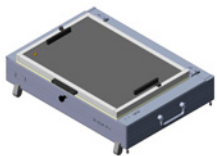

- Probe plate (KTP) made of CEM-1
- Incl. unloaded interface for 1,950x KT-158
- Incl. electric drive

VA 2501-2e/F/H/TD 88xx-S

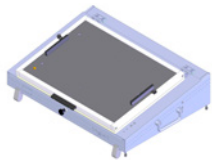

- Probe plate (KTP) made of CEM-1
- Incl. unloaded interface for 1,950x KT-158
- Incl. electric drive

VA 2501-2e/D/H/TD 88xx-S

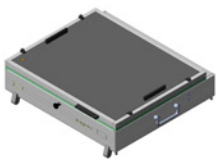

- Probe plate (KTP) made of FR4
- Incl. unloaded interface for 1,950x KT-158
- Incl. electric drive

VA 2601-2e/F/H/TD 88xx-S

**Features**

- Standard version with test system interface
- 10 mm thick probe plate (KTP) made of CEM-1 or FR4
- Hinged handle as carrying handle
- Single-sided single-stage or dual-stage contacting
- Dual-stage contacting with electrically operated shifting plate

**Technical specifications**

**Vacuum test fixtures**

- Maximum contact force: see table on page 90
- Parallel stroke: see table on page 90
- Outer dimensions (W x D x H):
  - VA 2030/F/H/TD 88xx-S: approx. 580 x 423 x 169 mm
  - VA 2030/D/H/TD 88xx-S: approx. 580 x 423 x 173 mm
  - VA 2040/F/H/TD 88xx-S: approx. 580 x 518 x 166 mm
  - VA 2501-2e/F/H/TD 88xx-S: approx. 580 x 423 x 171 mm
  - VA 2501-2e/D/H/TD 88xx-S: approx. 580 x 423 x 175 mm
  - VA 2601-2e/F/H/TD 88xx-S: approx. 580 x 518 x 173 mm
- Usable area (W x D):
  - VA 2030: approx. 345 x 215 mm
  - VA 2040: approx. 435 x 330 mm
  - VA 2501-2e: approx. 295 x 175 mm
  - VA 2601-2e: approx. 385 x 290 mm
- GKS installation height, bottom: 16.0 mm
- GKS installation height, 2-stage, bottom: 16.0 | 21.5 mm
- GKS theoretical working stroke: 4.0 mm (bottom)
- Operating temperature range: + 10 °C to + 60 °C

**Test system interface**

- TD 88xx-S: max. 1,950 KT-158 (bore Ø 1.1 mm), not included

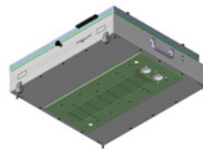

(see page 211)

**Ordering information**

Vacuum stand-alone test fixture		
Single-stage contacting (ICT / FCT stand-alone)		
Part no.: 19219	VA 2030/F/H/TD 88xx-S	KTP made of CEM-1, hinged handle, incl. interface
Part no.: 28293	VA 2030/D/H/TD 88xx-S	KTP made of CEM-1, hinged handle, incl. interface
Part no.: 22761	VA 2040/F/H/TD 88xx-S	KTP made of FR4, hinged handle, incl. interface
Dual-stage contacting (ICT/FCT combined)		
Part no.: 20772	VA 2501-2e/F/H/TD 88xx-S	KTP made of CEM-1, hinged handle, incl. electric drive, incl. interface
Part no.: 46309	VA 2501-2e/D/H/TD 88xx-S	KTP made of CEM-1, hinged handle, incl. electric drive, incl. interface
Part no.: 25398	VA 2601-2e/F/H/TD 88xx-S	KTP made of FR4, hinged handle, incl. electric drive, incl. interface

## Test system interface TSO5x

### Contacting single-sided single-stage (bottom)

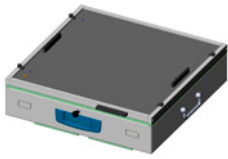

VA 2050/F/H/TSO5x

- Probe plate (KTP) made of FR4
- Prepared for mounting up to 2 test system interfaces TSO5x

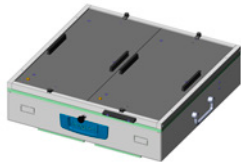

VA 2050T/F/H/TSO5x

- Tandem version
- Probe plate (KTP) made of FR4
- Prepared for mounting up to 2 test system interfaces TSO5x



Test system interface TSO5x

- Interface TSO5x fully loaded with 1,920 KT-158 02 (flat)

### VA 2050/F/H/TSO5x (with left mounted interface)

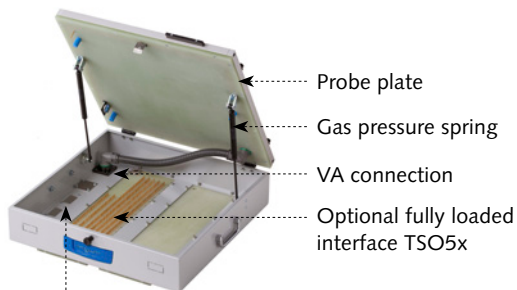

Recesses for mounting up to three I/O interface blocks

- Probe plate
- Gas pressure spring
- VA connection
- Optional fully loaded interface TSO5x

## Features

- Standard or tandem version without test system interface
- 10 mm thick bend-resistant probe plate made of FR4
- ESD-compliant pressure plate
- Mounting of up to two test system interfaces possible
- Single-sided single-stage contacting

## Technical specifications

### Vacuum test fixtures

- Maximum contact force: see table on page 90
- Parallel stroke: see table on page 90
- Outer dimensions (W x D x H):
  - VA 2050/F/H/TSO5x: approx. 540 x 535 x 152 mm
  - VA 2050T/F/H/TSO5x: approx. 540 x 535 x 152 mm
- Interface TSO5x: approx. 496 x 152 x 6,5 mm
- Usable area (W x D):
  - VA 2050: approx. 395 x 385 mm
  - VA 2050T: approx. 2 x 150 x 370 mm
- GKS installation height, bottom: 16.0 mm
- GKS theoretical working stroke: 4.0 mm (bottom)
- Weight:
  - VA 2050/F/H/TSO5x: approx. 14.1 kg
  - VA 2050T/F/H/TSO5x: approx. 15.0 kg
- Operating temperature range: + 10 °C to + 60 °C

### Test system interface

- TSO5x: fully loaded, with 1,920 KT-158 02 (flat)

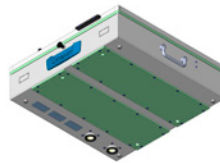

(see page 211)

## Ordering information

Vacuum stand-alone test fixture		
Single-stage contacting (ICT/FCT stand-alone)		
Part no.: 53430	VA 2050/F/H/TSO5x	KTP made of FR4, without test system interface
Part no.: 100737	VA 2050T/F/H/TSO5x	Tandem, KTP made of FR4, without test system interface
Accessories		
Part no.: 52680	Interface TSO5x	Fully loaded with 1,920 KT-158 02 (plan)

**Test system interface GR 228x 15/07**

**Contacting single-sided single-stage (bottom)**

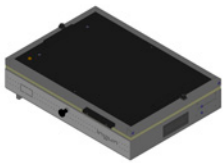

- Probe plate (KTP) made of CEM-1
- Incl. interface with 7 fully loaded slots

VA 2030/F/H/GR228x 15/07

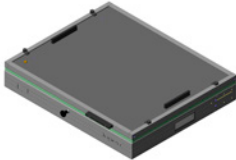

- Probe plate (KTP) made of FR4
- Incl. interface with 7 fully loaded slots

VA 2040/F/H/GR228x 15/07

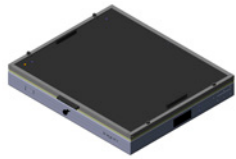

- Probe plate (KTP) made of CEM-1
- Incl. interface with 7 fully loaded slots

VA 2060/F/H/GR228x 15/07

**Contacting single-sided, dual-stage (bottom)**

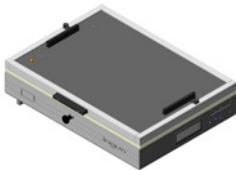

- Probe plate (KTP) made of CEM-1
- Incl. interface with 7 fully loaded slots
- Incl. electric drive

VA 2501-2e/F/H/GR228x 15/07

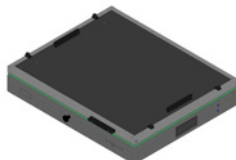

- Probe plate (KTP) made of FR4
- Incl. interface with 7 fully loaded slots
- Incl. electric drive

VA 2601-2e/F/H/GR228x 15/07

**Features**

- Standard version with test system interface
- 10 mm thick probe plate (KTP) made of CEM-1 or FR4
- Grip plate as carrying handle
- Single-sided, single-stage or dual-stage contacting
- Dual-stage contacting with electrically operated shifting plate

**Technical specifications**

**Vacuum test fixtures**

- Maximum contact force: see table on page 90
- Parallel stroke: see table on page 90
- Outer dimensions (W x D x H):
  - VA 2030/F/H/GR228x 15/07: approx. 460 x 367 x 136 mm
  - VA 2040/F/H/GR228x 15/07: approx. 550 x 487 x 136 mm
  - VA 2060/F/H/GR228x 15/07: approx. 654 x 587 x 136 mm
  - VA 2501-2e/F/H/GR228x 15/07: approx. 460 x 367 x 138 mm
  - VA 2601-2e/F/H/GR228x 15/07: approx. 554 x 487 x 140 mm
- Usable area (W x D):
  - VA 2030: approx. 345 x 215 mm
  - VA 2040: approx. 435 x 330 mm
  - VA 2060: approx. 535 x 440 mm
  - VA 2501-2e: approx. 295 x 175 mm
  - VA 2601-2e: approx. 385 x 290 mm
- GKS installation height, bottom: 16.0 mm
- GKS installation height, 2-stage, bottom: 16.0 | 21.5 mm
- GKS theoretical working stroke: 4.0 mm (bottom)
- Operating temperature range: + 10 °C to + 60 °C

**Test system interface**

- GR 228x 15/07: 7 slots fully loaded with 560 signal contact terminals

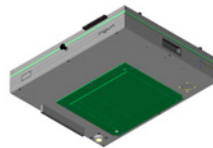

and 104 power contact terminals

**Ordering information**

Vacuum stand-alone test fixture		
Single-stage contacting (ICT/FCT stand-alone)		
Part no.: 16096	VA 2030/F/H/GR228x 15/07	KTP made of CEM-1, grip plate, incl. interface
Part no.: 8852	VA 2040/F/H/GR228x 15/07	KTP made of FR4, grip plate, incl. interface
Part no.: 22472	VA 2060/F/H/GR228x 15/07	KTP made of CEM-1, grip plate, incl. interface
Dual-stage contacting (ICT/FCT combined)		
Part no.: 49476	VA 2501-2e/F/H/GR228x 15/07	KTP made of CEM-1, grip plate, incl. electric drive, incl. interface
Part no.: 27051	VA 2601-2e/F/H/GR228x 15/07	KTP made of FR4, grip plate, incl. electric drive, incl. interface
Accessories		
Part no.: 17513	Signal contact terminal	Replacement contact terminal for signal field interface
Part no.: 3609	Power contact terminal	Replacement contact terminal for power field interface



## Test system interface GR 228x 15/15

### Contacting single-sided, **single-stage** (bottom)

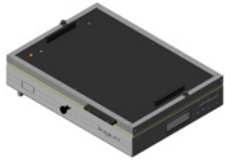

- Probe plate (KTP) made of CEM-1
- Incl. interface with 15 fully loaded slots

VA 2030/F/H/GR228x 15/15



- Probe plate (KTP) made of CEM-1
- Incl. interface with 15 fully loaded slots

VA 2030/F/H/HG/GR228x 15/15 (tall housing)

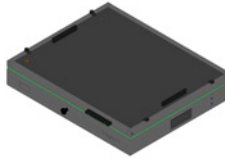

- Probe plate (KTP) made of FR4
- Incl. interface with 15 fully loaded slots

VA 2040/F/H/GR228x 15/15

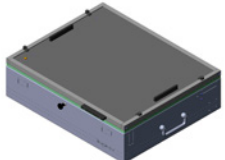

- Probe plate (KTP) made of FR4
- Incl. interface with 15 fully loaded slots

VA 2040/F/H/HG/GR228x 15/15 (tall housing)

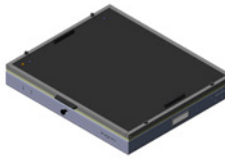

- Probe plate (KTP) made of CEM-1
- Incl. interface with 15 fully loaded slots

VA 2060/F/H/GR228x 15/15

### Contacting single-sided, **dual-stage** (bottom)

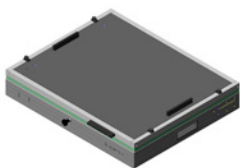

- Probe plate (KTP) made of FR4
- Incl. interface with 15 fully loaded slots
- Incl. electric drive

VA 2601-2e/F/H/GR228x 15/15

## Features

- Standard version with test system interface
- 10 mm thick probe plate (KTP) made of CEM-1 or FR4
- Grip plate or hinged handle as carrying handle
- Single-sided, single-stage or dual-stage contacting
- Dual-stage contacting with electrically operated shifting plate

## Technical specifications

### Vacuum test fixtures

- Maximum contact force: see table on page 90
- Parallel stroke: see table on page 90
- Outer dimensions (W x D x H):
  - VA 2030/F/H/GR228x 15/15: approx. 464 x 367 x 136 mm
  - VA 2030/F/H/HG/GR228x 15/15: approx. 490 x 367 x 196 mm
  - VA 2040/F/H/GR228x 15/15: approx. 550 x 487 x 136 mm
  - VA 2040/F/H/HG/GR228x 15/15: approx. 580 x 487 x 196 mm
  - VA 2060/F/H/GR228x 15/15: approx. 654 x 587 x 136 mm
  - VA 2601-2e/F/H/GR228x 15/15: approx. 550 x 487 x 140 mm
- Usable area (W x D):
  - VA 2030: approx. 345 x 215 mm
  - VA 2040: approx. 435 x 330 mm
  - VA 2060: approx. 535 x 440 mm
  - VA 2601-2e: approx. 385 x 290 mm
- GKS installation height, bottom: 16.0 mm
- GKS installation height, 2-stage, bottom: 16.0 | 21.5 mm
- GKS theoretical working stroke: 4.0 mm (bottom)
- Operating temperature range: + 10 °C to + 60 °C

### Test system interface

- GR 228x 15/15: 15 slots fully loaded, with 1,200 signal contact terminals

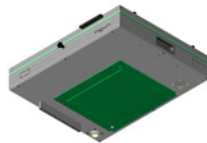

and 104 power contact terminals



## Ordering information

Vacuum stand-alone test fixture		
Single-stage contacting (ICT/FCT stand-alone)		
Part no.:	17319	VA 2030/F/H/GR228x 15/15
		KTP made of CEM-1, grip plate, incl. interface
Part no.:	31634	VA 2030/F/H/HG/GR228x 15/15
		Tall housing, KTP made of CEM-1, hinged handle, incl. interface
Part no.:	12833	VA 2040/F/H/GR228x 15/15
		KTP made of FR4, grip plate, incl. interface
Part no.:	31635	VA 2040/F/H/HG/GR228x 15/15
		Tall housing, KTP made of FR4, hinged handle, incl. interface
Part no.:	23341	VA 2060/F/H/GR228x 15/15
		KTP made of CEM-1, grip plate, incl. interface
Dual-stage contacting (ICT/FCT combined)		
Part no.:	17013	VA 2601-2e/F/H/GR228x 15/15
		KTP made of FR4, grip plate, incl. electric drive, incl. interface
Accessories		
Part no.:	17513	Signal contact terminal
		Contact terminal for signal field for interface re-equipping
Part no.:	3609	Power contact terminal
		Contact terminal for power field for interface re-equipping

**Test system interface GR 228x 18/18**

**Contacting single-sided, single-stage (bottom)**

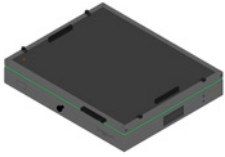

- Probe plate (KTP) made of FR4
- Incl. interface with 18 fully loaded slots

VA 2040/F/H/GR228x 18/18

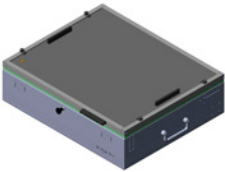

- Probe plate (KTP) made of FR4
- Incl. interface with 18 fully loaded slots

VA 2040/F/H/HG/GR228x 18/18 (tall housing)

**Contacting single-sided, dual-stage (bottom)**

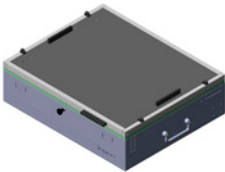

- Probe plate (KTP) made of FR4
- Incl. interface with 18 fully loaded slots
- Incl. electric drive

VA 2601-2e/F/H/HG/GR228x 18/18 (tall housing)

**Features**

- Standard version with test system interface
- 10 mm thick probe plate (KTP) made of FR4
- Grip plate or hinged handle as carrying handle
- Single-sided, single-stage or dual-stage contacting
- Dual-stage contacting with electrically operated shifting plate

**Technical specifications**

**Vacuum test fixtures**

- Maximum contact force: see table on page 90
- Parallel stroke: see table on page 90
- Outer dimensions (W x D x H):
  - VA 2040/F/H/GR228x 18/18: approx. 550 x 487 x 136 mm
  - VA 2040/F/H/HG/GR228x 18/18: approx. 580 x 487 x 196 mm
  - VA 2601-2e/F/H/HG/GR228x 18/18: approx. 580 x 487 x 200 mm
- Usable area (W x D):
  - VA 2040: approx. 435 x 330 mm
  - VA 2601-2e: approx. 385 x 290 mm
- GKS installation height, bottom: 16.0 mm
- GKS installation height, 2-stage, bottom: 16.0 | 21.5 mm
- GKS theoretical working stroke: 4.0 mm (bottom)
- Operating temperature range: + 10 °C to + 60 °C

**Test system interface**

- GR 228x 18/18: 18 slots fully loaded, with 1,440 signal contact terminals

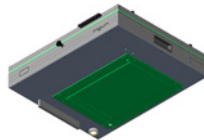

and 104 power contact terminals



**Ordering information**

Vacuum stand-alone test fixture		
Single-stage contacting (ICT/FCT stand-alone)		
Part no.:	15980 VA 2040/F/H/GR228x 18/18	KTP made of FR4, grip plate, incl. interface
Part no.:	31716 VA 2040/F/H/HG/GR228x 18/18	Tall housing, KTP made of FR4, hinged handle, incl. interface
Dual-stage contacting (ICT/FCT combined)		
Part no.:	41696 VA 2601-2e/F/H/HG/GR228x 18/18	Tall housing, KTP made of FR4, hinged handle, incl. electric drive, incl. interface
Accessories		
Part no.:	17513 Signal contact terminal	Contact terminal for signal field for interface re-equipping
Part no.:	3609 Power contact terminal	Contact terminal for power field for interface re-equipping

## Test system interface GR 2270/71

### Contacting single-sided, single-stage (bottom)

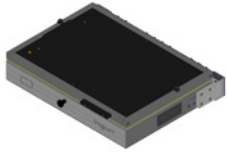

- Probe plate (KTP) made of CEM-1
- 1x VA connection PG16

VA 2030/F/H/GR2270/71

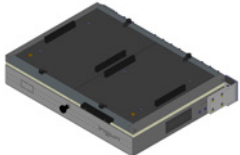

- Tandem version
- Probe plate (KTP) made of CEM-1
- 2x VA connection PG16

VA 2130/F/H/GR2270/71

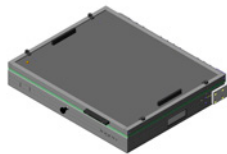

- Probe plate (KTP) made of FR4
- 1x VA connection PG16

VA 2040/F/H/GR2270/71

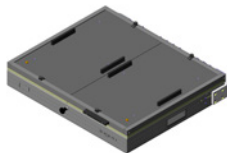

- Tandem version
- Probe plate (KTP) made of CEM-1
- 2x VA connection PG16

VA 2140/F/H/GR2270/71

### Contacting single-sided, dual-stage (bottom)

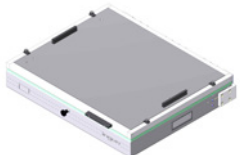

- Probe plate (KTP) made of FR4
- 1x VA connection PG16
- Incl. electric drive

VA 2601-2e/F/H/GR2270/71

## Features

- Standard or tandem version with test system interface
- 10 mm thick probe plate (KTP) made of CEM-1 or FR4
- Grip plate as carrying handle
- Single-sided single-stage or dual-stage contacting
- Dual-stage contacting with electrically operated shifting plate

## Technical specifications

### Vacuum test fixtures

- Maximum contact force: see table on page 90
- Parallel stroke: see table on page 90
- Outer dimensions (W x D x H):
  - VA 2030/F/H/GR2270/71: approx. 483 x 391 x 103 mm
  - VA 2130/F/H/GR2270/71: approx. 483 x 391 x 103 mm
  - VA 2040/F/H/GR2270/71: approx. 567 x 511 x 105 mm
  - VA 2140/F/H/GR2270/71: approx. 567 x 511 x 105 mm
  - VA 2601-2e/F/H/GR2270/71: approx. 567 x 511 x 109 mm
- Usable area (W x D):
  - VA 2030: approx. 345 x 215 mm
  - VA 2130: approx. 2x 130 x 220 mm
  - VA 2040: approx. 435 x 330 mm
  - VA 2140: approx. 2x 175 x 340 mm
  - VA 2601-2e: approx. 385 x 290 mm
- GKS installation height, bottom: 16.0 mm
- GKS installation height, 2-stage, bottom: 16.0 | 21.5 mm
- GKS theoretical working stroke: 4.0 mm (bottom)
- Operating temperature range: + 10 °C to + 60 °C

### Test system interface

- GR 2270/71: max. 10 interface blocks SB-P (DUT side) for max. 1,700 signals (not included), e.g.

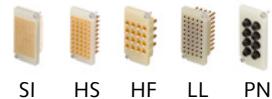
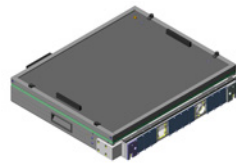

### Note:

Suitable interface blocks for equipping the Teradyne GenRad Pylon test system interface can be found on page 155 onwards.

## Ordering information







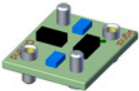

Vacuum stand-alone test fixture		
Single-stage contacting (ICT/FCT stand-alone)		
Part no.: 3802	VA 2030/F/H/GR2270/71	KTP made of CEM-1, grip plate, 1x VA connection PG16
Part no.: 4672	VA 2130/F/H/GR2270/71	Tandem, KTP made of CEM-1, grip plate, 2x VA connection PG16
Part no.: 3812	VA 2040/F/H/GR2270/71	KTP made of FR4, grip plate, 1x VA connection PG16
Part no.: 4673	VA 2140/F/H/GR2270/71	Tandem, KTP made of CEM-1, grip plate, 2x VA connection PG16
Dual-stage contacting (ICT/FCT combined)		
Part no.: 13963	VA 2601-2e/F/H/GR2270/71	KTP made of FR4, grip plate, 1x VA connection PG16, incl. electric drive

Series: Customisation accessories  
Compatible test fixture: VA for TERADYNE test systems

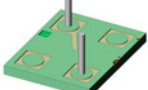
Test system interface contact (GKS)



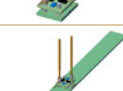
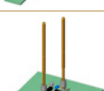
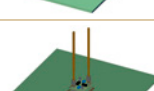

	Part number	Description	Version	Compatible with
	GKS-938 307 180 A 1500	Spring-loaded test probe	Spring force: 1.5 N	Test system interface GR 228x XX/XX

FrameScan Opens test components (OTC/OTU)

	Part number	Description	Version	Compatible with
	GKS-925 TJ A 1000-S	Spring-loaded test probe	Floating mounting, Spring force: 1 N	FrameScanPlus FrameScanFX2.0
	26486	OTC-TD-FX-EP	Electronics plate FrameScanFX2.0	
	14762	OTC-TD-FS-EP-GKS	Electronics plate FrameScanPlus incl. 2x GKS-925 TJ A 1000-S	
	14763	OTC-TD-FS-SP-013-010	Sensor plate 013-010 Area: 9.5 x 12.1 mm (0.375 x 0.475 ")	
	14765	OTC-TD-FS-SP-159-013	Sensor plate 159-013 Area: 12.7 x 158.8 mm (0.500 x 6.250 ")	
	14766	OTC-TD-FS-SP-032-032	Sensor plate 032-032 Area: 31.8 x 31.8 mm (1.25 x 1.25 ")	
	14767	OTC-TD-FS-SP-065-065	Sensor plate 065-065 Area: 65.02 x 65.02 mm (2.56 x 2.56 ")	
	54777	OTU-TD-FS-013-010	FrameScanPlus 013-010 incl. Electronics plate and 2x GKS-925 TJ A 1000-S	
	54776	OTU-TD-FS-159-013	FrameScanPlus 159-013 incl. Electronics plate and 2x GKS-925 TJ A 1000-S	
	54775	OTU-TD-FS-032-032	FrameScanPlus 032-032 incl. Electronics plate and 2x GKS-925 TJ A 1000-S	
	54774	OTU-TD-FS-065-065	FrameScanPlus 065-065 incl. Electronics plate and 2x GKS-925 TJ A 1000-S	
	54778	OTU-TD-FX-032-032	FrameScanFX2.0 032-032 incl. Electronics plate and 2x GKS-925 TJ A 1000-S	

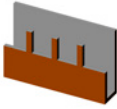
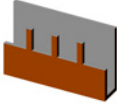
VA with  
Test system  
interface

### CapScan Opens test components (OTC/OTU)

	Part number	Description	Version	Compatible with
	12314	OTC-KS-TJ-PC-GKS Spring-loaded test probe	Spring force: 1 N	CapScan
	12315	OTC-KS-TJ-PC-SP-007-004	Sensor plate B/C - Size Area: 6.5 x 3.8 mm	
	12316	OTC-KS-TJ-PC-SP-008-005	Sensor plate D - Size Area: 7.6 x 4.9 mm	
	12313	OTC-KS-TJ-PC-EP	Electronics plate	
	19643	OTU-TD-FX-CS-007-004	CapScan B/C - Size incl. electronics plate and 2x OTC-KS-TJ-PC-GKS	
	19644	OTU-TD-FX-CS-008-005	CapScan D - Size incl. electronics plate and 2x OTC-KS-TJ-PC-GKS	

### FrameScan control electronics (OTE) interface Opens Test components (Selector Boards), not included

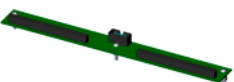
	Part number	Description	Version	Compatible with
	31737	OTE-TD-FX-064-MUX	FrameScan FX 2.0 Selector Board (2x 64 contacts)	- FrameScanPlus - FrameScanFX2.0
	31738	OTE-TD-FX-064-MUX-SET	FrameScan FX 2.0 Selector Board incl. assembly parts (2x 64 contacts)	

### Opens Test Components (OTE/OTC/OTU)

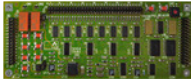
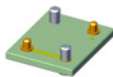
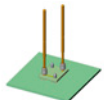
	Part number	Description	Version	Compatible with
	22373	OTE-TS-OE-032-OFM	Opens Test Electronic OFM-Board GR	OpensXpress
	22374	OTC-TS-OE-EP	Electronics plate (OpensXpress)	
	54773	OTU-TS-OE-032-032	OpensXpress 1.2 totally incl. electronics plate and 2x GKS-925 TJ A 1000-S	

**Note:**

Recommended receptacles to determine the installation height of the Open Test components can be found on page 108.

**Note:**

Pressure frame unit for mounting Opens Test components (FrameScan) can be found on page 106.



Contacting: Single/Dual-stage (ICT/FCT stand-alone | combined)

**Test system interface PYLON**

**Contacting single-sided single-stage (bottom)**

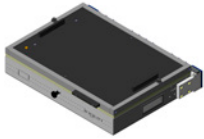

- Probe plate (KTP) made of CEM-1
- 1x VA connection PG16

VA 2030/F/H/Pylon

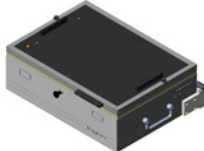

- Probe plate (KTP) made of CEM-1
- 1x VA connection PG16

VA 2030/F/H/HG/Pylon (tall housing)

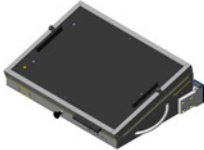

- Probe plate (KTP) made of CEM-1
- 1x VA connection PG16

VA 2030/D/H/Pylon

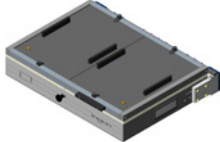

- Tandem version
- Probe plate (KTP) made of CEM-1
- 2x VA connection PG16

VA 2130/F/H/Pylon

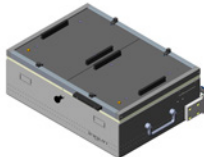

- Tandem version
- Probe plate (KTP) made of CEM-1
- 2x VA connection PG16

VA 2130/F/H/HG/Pylon (tall housing)

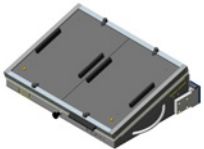

- Tandem version
- Probe plate (KTP) made of CEM-1
- 2x VA connection PG16

VA 2130/D/H/Pylon

**Contacting single-sided, dual-stage (bottom)**

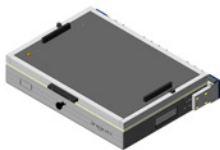

- Probe plate (KTP) made of CEM-1
- 1x VA connection PG16
- Incl. electric drive

VA 2501-2e/F/H/Pylon

**Features**

- Standard or tandem version with test system interface
- 10 mm thick probe plate (KTP) made of CEM-1
- Grip plate, hinged handle or bow handle as carrying handle
- Single-sided single-stage or dual-stage contacting
- Dual-stage contacting with electrically operated shifting plate

**Technical specifications**

**Vacuum test fixtures**

- Maximum contact force: see table on page 90
- Parallel stroke: see table on page 90
- Outer dimensions (W x D x H):
  - VA 2030/F/H/Pylon: approx. 483 x 391 x 105 mm
  - VA 2030/F/H/HG/Pylon: approx. 483 x 391 x 167 mm
  - VA 2030/D/H/Pylon: approx. 530 x 375 x 150 mm
  - VA 2130/F/H/Pylon: approx. 483 x 391 x 105 mm
  - VA 2130/F/H/HG/Pylon: approx. 483 x 391 x 167 mm
  - VA 2130/D/H/Pylon: approx. 530 x 375 x 160 mm
  - VA 2501-2e/F/H/Pylon: approx. 483 x 391 x 108 mm
- Usable area (W x D):
  - VA 2030: approx. 345 x 215 mm
  - VA 2130: approx. 2x 130 x 220 mm
  - VA 2501-2e: approx. 295 x 175 mm
- GKS installation height, bottom: 16.0 mm
- GKS installation height, 2-stage, bottom: 16.0 | 21.5 mm
- GKS theoretical working stroke: 4.0 mm (bottom)
- Operating temperature range: + 10 °C to + 60 °C

**Test system interface**

- Pylon: max. 10 interface blocks SB-P (DUT side) for max. 1,700 signals (not included), e.g.

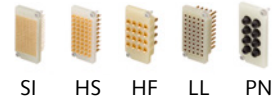
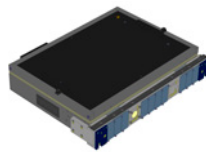

**Note:**  
 Suitable interface blocks for equipping the Pylon test system interface can be found on page 155 onwards.

**Ordering information**

Vacuum stand-alone test fixture		
Single-stage contacting (ICT/FCT stand-alone)		
Part no.: 4116	VA 2030/F/H/Pylon	KTP made of CEM-1, grip plate, 1x VA connection PG16
Part no.: 31310	VA 2030/F/H/HG/Pylon	Tall housing, KTP made of CEM-1, hinged handle, 1x VA connection PG16
Part no.: 25818	VA 2030/D/H/Pylon	KTP made of CEM-1, bow handle, 1x VA connection PG16
Part no.: 13851	VA 2130/F/H/Pylon	Tandem, KTP made of CEM-1, grip plate, 2x VA connection PG16
Part no.: 45641	VA 2130/F/H/HG/Pylon	Tandem, tall housing, KTP made of CEM-1, hinged handle, 2x VA connec. PG16
Part no.: 15879	VA 2130/D/H/Pylon	Tandem, KTP made of CEM-1, bow handle, 2x VA connection PG16
Dual-stage contacting (ICT/FCT combined)		
Part no.: 20977	VA 2501-2e/F/H/Pylon	KTP made of CEM-1, grip plate, 1x VA connection PG16, incl. electric drive

## Test system interface PYLON

### Contacting single-sided, single-stage (bottom)

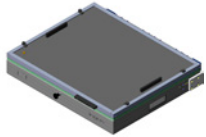

- Probe plate (KTP) made of FR4
- 1x VA connection PG16

VA 2040/F/H/Pylon

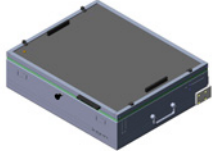

- Probe plate (KTP) made of FR4
- 1x VA connection PG16

VA 2040/F/H/HG/Pylon (tall housing)

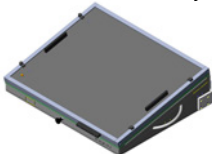

- Probe plate (KTP) made of FR4
- 1x VA connection PG16

VA 2040/D/H/Pylon

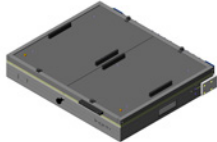

- Tandem version
- Probe plate (KTP) made of CEM-1
- 2x VA connection PG16

VA 2140/F/H/Pylon

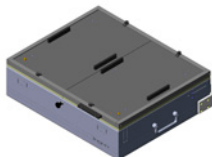

- Tandem version
- Probe plate (KTP) made of CEM-1
- 2x VA connection PG16

VA 2140/F/H/HG/Pylon (tall housing)

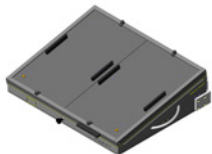

- Tandem version
- Probe plate (KTP) made of CEM-1
- 2x VA connection PG16

VA 2140/D/H/Pylon

### Contacting single-sided, dual-stage (bottom)

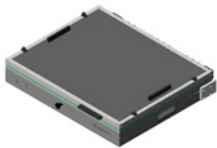

- Probe plate (KTP) made of FR4
- 1x VA connection PG16
- Incl. electric drive

VA 2601-2e/F/H/Pylon

## Features

- Standard or tandem version with test system interface
- 10 mm thick probe plate (KTP) made of CEM-1 or FR4
- Grip plate, hinged handle or bow handle as carrying handle
- Single-sided single-stage or dual-stage contacting
- Dual-stage contacting with electrically operated shifting plate

## Technical specifications

### Vacuum test fixtures

- Maximum contact force: see table on page 90
- Parallel stroke: see table on page 90
- Outer dimensions (W x D x H):
  - VA 2040/F/H/Pylon: approx. 568 x 511 x 105 mm
  - VA 2040/F/H/HG/Pylon: approx. 580 x 511 x 167 mm
  - VA 2040/D/H/Pylon: approx. 620 x 499 x 153 mm
  - VA 2140/F/H/Pylon: approx. 568 x 511 x 105 mm
  - VA 2140/F/H/HG/Pylon: approx. 580 x 511 x 167 mm
  - VA 2140/D/H/Pylon: approx. 620 x 499 x 163 mm
  - VA 2601-2e/F/H/Pylon: approx. 568 x 511 x 108 mm
- Usable area (W x D):
  - VA 2040: approx. 435 x 330 mm
  - VA 2140: approx. 2x 175 x 340 mm
  - VA 2601-2e: approx. 385 x 290 mm
- GKS installation height, bottom: 16.0 mm
- GKS installation height, 2-stage, bottom: 16.0 | 21.5 mm
- GKS theoretical working stroke: 4.0 mm (bottom)
- Operating temperature range: + 10 °C to + 60 °C

### Test system interface

- Pylon: max. 10 interface blocks SB-P (DUT side) for max. 1,700 signals (not included), e.g.

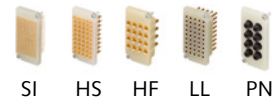
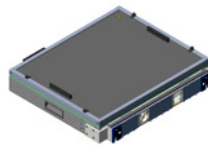

### Note:

Suitable interface blocks for equipping the Pylon test system interface can be found on page 155 onwards.

## Ordering information

Vacuum stand-alone test fixture		
Single-stage contacting (ICT/FCT stand-alone)		
Part no.: 1226	VA 2040/F/H/Pylon	KTP made of FR4, grip plate, 1x VA connection PG16
Part no.: 28738	VA 2040/F/H/HG/Pylon	Tall housing, KTP made of FR4, hinged handle, 1x VA connection PG16
Part no.: 15481	VA 2040/D/H/Pylon	KTP made of FR4, bow handle, 1x VA connection PG16
Part no.: 4759	VA 2140/F/H/Pylon	Tandem, KTP made of CEM-1, grip plate, 2x VA connection PG16
Part no.: 32554	VA 2140/F/H/HG/Pylon	Tandem, tall housing, KTP made of CEM-1, hinged handle, 2x VA connection PG16
Part no.: 31426	VA 2140/D/H/Pylon	Tandem, KTP made of CEM-1, bow handle, 2x VA connection PG16
Dual-stage contacting (ICT/FCT combined)		
Part no.: 16001	VA 2601-2e/F/H/Pylon	KTP made of FR4, grip plate, 1x VA connection PG16, incl. electric drive

Series: VA xxxx  
 Sizes: VA 2060, INGUN Pylon receiver  
 Test system interface: Pylon | ITA-14  
 Contacting: Single-stage (ICT/FCT stand-alone)

**Test system interface PYLON**

**Contacting single-sided, single-stage (bottom)**

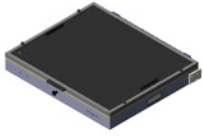

- Probe plate (KTP) made of CEM-1
- 1x VA connection PG16

VA 2060/F/H/Pylon

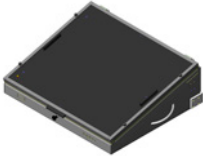

- Probe plate (KTP) made of CEM-1
- 1x VA connection PG16

VA 2060/D/H/Pylon

**Test system interface ITA-14**

**Contacting single-sided, single-stage (bottom)**

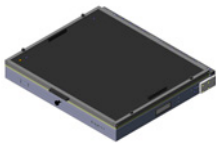

- Probe plate (KTP) made of CEM-1
- 1x VA connection PG16

VA 2060/F/H/ITA-14

**Features**

- Standard version with test system interface
- 10 mm thick probe plate (KTP) made of CEM-1
- Grip plate or bow handle as carrying handle
- Single-sided, single-stage contacting from the bottom

**Technical specifications**

**Vacuum test fixtures**

- Maximum contact force: see table on page 90
- Parallel stroke: see table on page 90
- Outer dimensions (W x D x H):
  - VA 2060/F/H/Pylon: approx. 668 x 610 x 105 mm
  - VA 2060/D/H/Pylon: approx. 718 x 610 x 220 mm
  - VA 2060/F/H/ITA-14: approx. 673 x 610 x 105 mm
  - RC-Pylon-12-V2: approx. 556 x 620 x 165 mm
- Usable area (W x D):
  - VA 2060: approx. 535 x 440 mm
- GKS installation height, bottom: 16.0 mm
- GKS theoretical working stroke: 4.0 mm (bottom)
- Operating temperature range: + 10 °C to + 60 °C

**Test system interface**

- Pylon: max. 10 interface blocks SB-P (DUT side) for max. 1,700 signals (not included), e.g.

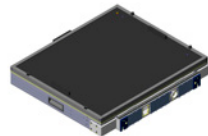

- ITA-14: max. 14 interface blocks SB-P (DUT side) for max. 2,380 signals (not included), e.g.

- ITA-14:

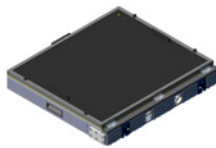

**INGUN PYLON receiver RC-Pylon-12-V2 for test fixture with Pylon interface**

- One-hand operation
- Tightening mechanism with latch guide by means of gear wheel drive without clearance
- Incl. earthing contact, inspection window, and protective earth wiring
- Space for 10 interfaces blocks SB-T (test system side) and 2x VA connection

**Note:**  
 Suitable interface blocks for equipping the Pylon test system interface can be found on page 155 onwards.

VA with Test system interface

**Ordering information**

Vacuum stand-alone test fixture		
Single-stage contacting (ICT/FCT stand-alone)		
Part no.: 35443	VA 2060/F/H/Pylon	KTP made of CEM-1, grip plate, 1x VA connection PG16
Part no.: 53615	VA 2060/D/H/Pylon	KTP made of CEM-1, bow handle, 1x VA connection PG16
Part no.: 9939	VA 2060/F/H/ITA-14	KTP made of CEM-1, grip plate, 1x VA connection PG16
INGUN Pylon receiver		
Part no.: 32162	RC-Pylon-12-V2	Pylon receiver for 10 interface blocks SB-T and 2x VA connection PG16
Accessories		
Part no.: 22470	SB-T-SO-001 vacuum flange	Vacuum connection for Pylon receiver RC-Pylon-12-V2
Part no.: 30929	SB-P-SO-001 vacuum flange	Vacuum connection for Pylon test system interface

## Test system interface VPC-G12-12

### Contacting single-sided **single-stage** (bottom)

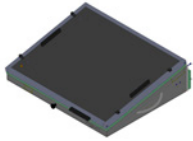

- Probe plate (KTP) made of FR4
- Without interface
- Without VPC VA module

VA 2040/D/H/VPC-G12

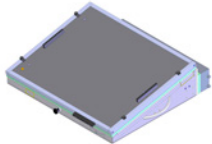

- Probe plate (KTP) made of FR4
- Incl. interface
- Incl. VPC VA module

VA 2040/D/H/VPC-G12

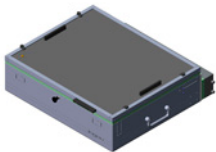

- Probe plate (KTP) made of FR4
- Incl. interface
- Without VPC VA module

VA 2040/F/H/VPC-G12

### Contacting single-sided, **dual-stage** (bottom)

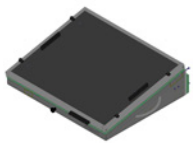

- Probe plate (KTP) made of FR4
- Without interface
- Without VPC VA module
- Incl. electric drive

VA 2601-2e/D/H/VPC-G12

## Features

- Standard version with/without test system interface
- 10 mm thick probe plate made of FR4
- Bow handle or hinged handle as carrying handle
- Single-sided single-stage or dual-stage contacting
- Dual-stage contacting with electrically operated shifting plate

## Technical specifications

### Vacuum test fixtures

- Maximum contact force: see table on page 90
- Parallel stroke: see table on page 90
- Outer dimensions (W x D x H):
  - VA 2040/D/H/VPC-G12: approx. 620 x 490 x 155 mm
  - VA 2040/D/H/VPC-G12: approx. 620 x 532 x 155 mm (incl. test system interface)
  - VA 2040/F/H/VPC-G12: approx. 580 x 544 x 165 mm
  - VA 2601-2e/D/H/VPC-G12: approx. 620 x 490 x 155 mm
- Usable area (W x D):
  - VA 2040: approx. 435 x 330 mm
  - VA 2601-2e: approx. 385 x 290 mm
- GKS installation height, bottom: 16.0 mm
- GKS installation height, 2-stage, bottom: 16.0 | 21.5 mm
- GKS theoretical working stroke: 4.0 mm (bottom)
- Operating temperature range: + 10 °C to + 60 °C

### Test system interface

- VPC-G12-12: for max. 1x VPC VA module, not included



+ 10x VPC signal module for max. 1,920 signals



and/or  
+ 10x VPC power module for max. 190 power signals



## Ordering information

Vacuum stand-alone test fixture		
Single-stage contacting (ICT/FCT stand-alone)		
Part no.: 35615	VA 2040/D/H/VPC-G12	KTP made of FR4, bow handle, without interface, without VPC VA module
Part no.: 26639	VA 2040/D/H/VPC-G12	KTP made of FR4, bow handle, incl. interface, incl. VPC VA module
Part no.: 45487	VA 2040/F/H/VPC-G12	KTP made of FR4, hinged handle, incl. interface, without VPC VA module
Dual-stage contacting (ICT/FCT combined)		
Part no.: 47914	VA 2601-2e/D/H/VPC-G12	KTP made of FR4, bow handle, incl. electric drive, without interface, without VPC VA module

Accessories		
Part no.: 22745	Interface VPC-G12-12	Unloaded for 1x VPC VA module and 10x VPC signal/power module
Part no.: 22908	VPC VA module	2x VA connection each with M22.5 x 1.5 connection thread
Part no.: 23944	VPC signal module	Unloaded for 192 contact terminals for signal transmission
Part no.: 24595	Contact terminal to VPC signal module	Signal contact terminal with wire-wrap post
Part no.: 22910	VPC power module	Unloaded for 19 contact terminals for power transmission
Part no.: 22911	Contact terminal to VPC power module	Power contact terminal, 50 A, with soldering connection



### Test system interface VPC-G12x-18

#### Contacting single-sided, single-stage (bottom)

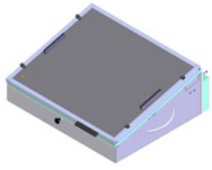

- Probe plate (KTP) made of FR4
- Without interface
- Incl. VPC VA module

VA 2040/D/H/HG/VPC-G12x-18

#### Contacting single-sided, dual-stage (bottom)

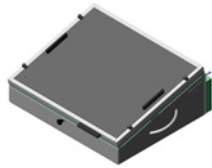

- Probe plate (KTP) made of FR4
- Without interface
- Incl. VPC VA module
- Incl. electric drive

VA 2601-2e/D/H/HG/VPC-G12x-18

### Features

- Standard version without test system interface
- 10 mm thick probe plate made of FR4
- Bow handle as carrying handle
- Single-sided single-stage or dual-stage contacting
- Dual-stage contacting with electrically operated shifting plate

### Technical specifications

#### Vacuum test fixtures

- Maximum contact force: see table on page 90
- Parallel stroke: see table on page 90
- Outer dimensions (W x D x H):
  - VA 2040/D/H/HG/VPC-G12x-18: approx. 620 x 500 x 213 mm
  - VA 2601-2e/D/H/HG/VPC-G12x-18: approx. 620 x 500 x 215 mm
- Usable area (W x D):
  - VA 2040: approx. 435 x 330 mm
  - VA 2601-2e: approx. 385 x 290 mm
- GKS installation height, bottom: 16.0 mm
- GKS installation height, 2-stage, bottom: 16.0 | 21.5 mm
- GKS theoretical working stroke: 4.0 mm (bottom)
- Operating temperature range: + 10 °C to + 60 °C

#### Test system interface

- VPC-G12x-18: for max. 1x VPC VA module, not included

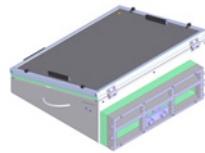

+ 16x VPC signal module for max. 3,072 signals



and/or  
+ 16x VPC power module for max. 304 power signals



## Ordering information

Vacuum stand-alone test fixture		
Single-stage contacting (ICT/FCT stand-alone)		
Part No: 43184	VA 2040/D/H/HG/VPC-G12x-18	KTP made of FR4, bow handle , without interface, incl. VPC VA module
Dual-stage contacting (ICT/FCT combined)		
Part no.: 47731	VA 2601-2e/D/H/HG/VPC-G12x-18	KTP made of FR4, bow handle , incl. electric drive, without interface, incl. VPC VA module

Accessories		
Part no.: 37797	Interface VPC-G12x-18	Unloaded for 1x VPC VA module and 16x VPC signal/power module
Part no.: 22908	VPC VA module	2-fold VA connection with each M22.5 x 1.5 connection thread
Part no.: 23944	VPC signal module	Unloaded for 192 contact terminals for signal transmission
Part no.: 24595	Contact terminal to VPC signal module	Signal contact terminal with wire-wrap post
Part no.: 22910	VPC power module	Unloaded for 19 contact terminals for power transmission
Part no.: 22911	Contact terminal to VPC power module	Power contact terminal, 50 A, with soldering connection



Description	Part number	Version	Test system interface	Contacting	Max. contact force [N]	Parallel stroke [mm]	Outer dimensions (W x D x H mm)	Typical usable area (W x D mm)
VA 2040/F/H/ MC 4200/4210	20229	Standard	COBHAM (AEROFLEX)	1-stage	14,000	8.5	550 x 557 x 137	435 x 335
VA 2040/F/H/ MC 4200/4210	9904	Standard	COBHAM (AEROFLEX)	1-stage	14,000	8.5	550 x 557 x 137	435 x 335
VA 2140/F/H/ MC 4200/4210	12736	Tandem	COBHAM (AEROFLEX)	1-stage	2x 6,000	8.5	550 x 557 x 137	2x 175 x 340
VA 2040/F/H/ AF 4200/4250	30625	Standard	COBHAM (AEROFLEX)	1-stage	14,000	8.5	550 x 532 x 132	435 x 335
VA 2601-2e/F/H/ MC 4200/4210	25754	Standard	COBHAM (AEROFLEX)	2-stage (ICT+FCT)	14,000	12	550 x 557 x 142	385 x 290
VA 2601-2e/F/H/ MC 4200/4210	18210	Standard	COBHAM (AEROFLEX)	2-stage (ICT+FCT)	14,000	12	550 x 557 x 142	385 x 290
VA 2040/D/H/ MTS 100	10932	Standard	DIGITALTEST	1-stage	14,000	8.5	620 x 532 x 153	435 x 330
VA 2040/D/H/ MTS 200	4758	Standard	DIGITALTEST	1-stage	14,000	8.5	620 x 504 x 157	435 x 330
VA 2040/D/H/ MTS 300	18000	Standard	DIGITALTEST	1-stage	14,000	8.5	645 x 532 x 181	435 x 330
VA 2140/D/H/ MTS 300	21629	Tandem	DIGITALTEST	1-stage	2x 6,000	8.5	645 x 532 x 190	2x 175 x 340
VA 2601-2e/D/H/ MTS 300	18510	Standard	DIGITALTEST	2-stage (ICT+FCT)	14,000	12	645 x 532 x 183	385 x 290
VA 2070S/ i3070-5	4844- KIT	Small	KEYSIGHT	1-stage	11,000	7	465 x 460 x 100	305 x 380
VA 2070S/HZL/ i3070-5	18131	Small	KEYSIGHT	1-stage	11,000	7	465 x 460 x 100	305 x 380
VA 2070S/VKH/SOP/ i3070-5	101746	- Small - Self-opener	KEYSIGHT	1-stage	11,000	7	465 x 482 x 186	300 x 350
VA 2070S/ZSK-P/ i3070-5	18084	Small	KEYSIGHT	1-stage	11,000	7	567 x 539 x 165	280 x 350
VA 2070S/HZL/ZSK-P/ i3070-5	18843	Small	KEYSIGHT	1-stage	11,000	7	567 x 539 x 165	280 x 350
VA 2070S/ZSK-70/ i3070-5	27005	Small	KEYSIGHT	1-stage	11,000	7	465 x 460 x 151	230 x 310
VA 2070S/HZL/ZSK-70/ i3070-5	30685	Small	KEYSIGHT	1-stage	11,000	7	465 x 460 x 151	230 x 310
VA 2070SR/ i3070-5	4998	Small (ADP reduced)	KEYSIGHT	1-stage	8,000	7	465 x 460 x 100	305 x 230
VA 2070ST/ i3070-5	10319	- Small - Tandem	KEYSIGHT	1-stage	2x 5,000	7	465 x 460 x 100	2x 100 x 380
VA 2070ST/ZSK-70/ i3070-5	27964	- Small - Tandem	KEYSIGHT	1-stage	2x 5,000	7	465 x 460 x 151	2x 100 x 310
VA 2070S/VKH/SN/ i3070-5	27779	- Small - Rigid pin	KEYSIGHT	1-stage	11,000	7	465 x 460 x 236	260 x 310
VA 2070S/HZR/ZSK-P/SN/ i3070-5	56930	- Small - Rigid pin	KEYSIGHT	1-stage	11,000	7	640 x 539 x 216	260 x 310
VA 2070S-2e/ i3070-5	14251	Small	KEYSIGHT	2-stage (ICT+FCT)	11,000	12	465 x 460 x 105	270 x 335

Description	Part number	Version	Test system interface	Contacting	Max. contact force [N]	Parallel stroke [mm]	Outer dimensions (W x D x H mm)	Typical usable area (W x D mm)
VA 2070S-2e/HZL/i3070-5	18781	Small	KEYSIGHT	2-stage (ICT+FCT)	11,000	12	465 x 460 x 105	270 x 335
VA 2070S-2e/HZL/ZSK-P/i3070-5	28715	Small	KEYSIGHT	2-stage, 1-stage	11,000	12	567 x 539 x 165	270 x 330
VA 2070S-2e/ZSK-P-2e/i3070-5	28900	Small	KEYSIGHT	2-stage (ICT+FCT)	11,000	12	567 x 539 x 185	270 x 310
VA 2073L/i3070-5	8326	Large	KEYSIGHT	1-stage	24,000	7	827 x 460 x 100	670 x 380
VA 2073L/HZL/i3070-5	25517	Large	KEYSIGHT	1-stage	24,000	7	827 x 460 x 100	670 x 380
VA 2073L/HZL/ZSK-P/i3070-5	25522	Large	KEYSIGHT	1-stage	24,000	7	928 x 539 x 163	630 x 350
VA 2073L-2e/i3070-5	37737	Large	KEYSIGHT	2-stage (ICT+FCT)	24,000	12	838 x 460 x 105	650 x 335
VA 2035/D/H/RH	17293	Standard	REINHARDT	1-stage	9,000	8.5	578 x 435 x 247	305 x 305
VA 2040/D/H/RH	12421	Standard	REINHARDT	1-stage	14,000	8.5	700 x 476 x 215	435 x 330
VA 2035-2e/D/H/RH	34834	Standard	REINHARDT	2-stage (ICT+FCT)	9,000	12	578 x 435 x 251	265 x 265
VA 2020/D/H/Spa 501	20842	Standard	SPEA	1-stage	12,000	8.5	489 x 622 x 226	370 x 280
VA 2040/D/H/Spa 501	25338	Standard	SPEA	1-stage	14,000	8.5	550 x 625 x 175	435 x 330
VA 2140/D/H/Spa 501	35340	Tandem	SPEA	1-stage	2x 6,000	8.5	550 x 620 x 182	2x 175 x 340
VA 2020-2e/D/H/Spa 501	20850	Standard	SPEA	2-stage (ICT+FCT)	12,000	12	489 x 622 x 230	330 x 260
VA 2601-2e/D/H/Spa 501	44260	Standard	SPEA	2-stage (ICT+FCT)	14,000	12	550 x 625 x 177	385 x 290
VA 2030/D/H/TD Z1800-M/VAL	13516	Standard	TERADYNE	1-stage	9,000	8.5	595 x 353 x 168	345 x 215
VA 2040/D/H/TD Z1800-M/VAL	13517	Standard	TERADYNE	1-stage	14,000	8.5	628 x 476 x 168	435 x 330
VA 2050/F/H/TSO5x	53430	Standard	TERADYNE	1-stage	15,000	8.5	540 x 535 x 152	395 x 385
VA 2050T/F/H/TSO5x	100737	Tandem	TERADYNE	1-stage	2x 7,000	8.5	540 x 535 x 152	2x 150 x 370
VA 2040/F/H/TD 88xx-M	14420	Standard	TERADYNE	1-stage	14,000	8.5	580 x 518 x 166	435 x 330
VA 2601-2e/F/H/TD 88xx-M	13898	Standard	TERADYNE	2-stage (ICT+FCT)	14,000	12	580 x 518 x 171	385 x 290
VA 2030/F/H/TD 88xx-S	19219	Standard	TERADYNE	1-stage	9,000	8.5	580 x 423 x 169	345 x 215
VA 2030/D/H/TD 88xx-S	28293	Standard	TERADYNE	1-stage	9,000	8.5	580 x 423 x 173	345 x 215
VA 2040/F/H/TD 88xx-S	22761	Standard	TERADYNE	1-stage	14,000	8.5	580 x 518 x 166	435 x 330

Description	Part number	Version	Test system interface	Contacting	Max. contact force [N]	Parallel stroke [mm]	Outer dimensions (W x D x H mm)	Typical usable area (W x D mm)
VA 2501-2e/F/H/ TD 88xx-S	20772	Standard	TERADYNE	2-stage (ICT+FCT)	9,000	12	580 x 423 x 171	295 x 175
VA 2501-2e/D/H/ TD 88xx-S	46309	Standard	TERADYNE	2-stage (ICT+FCT)	9,000	12	580 x 423 x 175	295 x 175
VA 2601-2e/F/H/ TD 88xx-S	25398	Standard	TERADYNE	2-stage (ICT+FCT)	14,000	12	580 x 518 x 173	385 x 290
VA 2030/F/H/ GR228x 15/07	16096	Standard	TERADYNE	1-stage	9,000	8.5	460 x 367 x 136	345 x 215
VA 2040/F/H/ GR228x 15/07	8852	Standard	TERADYNE	1-stage	14,000	8.5	550 x 487 x 136	435 x 330
VA 2060/F/H/ GR228x 15/07	22472	Standard	TERADYNE	1-stage	22,000	8.5	654 x 587 x 136	535 x 440
VA 2501-2e/F/H/ GR228x 15/07	49476	Standard	TERADYNE	2-stage (ICT+FCT)	9,000	12	460 x 367 x 138	295 x 175
VA 2601-2e/F/H/ GR228x 15/07	27051	Standard	TERADYNE	2-stage (ICT+FCT)	14,000	12	554 x 487 x 140	385 x 290
VA 2030/F/H/ GR228x 15/15	17319	Standard	TERADYNE	1-stage	9,000	8.5	464 x 367 x 136	345 x 215
VA 2030/F/H/HG/ GR228x 15/15	31634	Tall housing	TERADYNE	1-stage	9,000	8.5	490 x 367 x 196	345 x 215
VA 2040/F/H/ GR228x 15/15	12833	Standard	TERADYNE	1-stage	14,000	8.5	550 x 487 x 136	435 x 330
VA 2040/F/H/HG/ GR228x 15/15	31635	Tall housing	TERADYNE	1-stage	14,000	8.5	580 x 487 x 196	435 x 330
VA 2060/F/H/ GR228x 15/15	23341	Standard	TERADYNE	1-stage	22,000	8.5	654 x 587 x 136	535 x 440
VA 2601-2e/F/H/ GR228x 15/15	17013	Standard	TERADYNE	2-stage (ICT+FCT)	14,000	12	550 x 487 x 140	385 x 290
VA 2040/F/H/ GR228x 18/18	15980	Standard	TERADYNE	1-stage	14,000	8.5	550 x 487 x 136	435 x 330
VA 2040/F/H/HG/ GR228x 18/18	31716	Tall housing	TERADYNE	1-stage	14,000	8.5	580 x 487 x 196	435 x 330
VA 2601-2e/F/H/HG/ GR228x 18/18	41696	Tall housing	TERADYNE	2-stage (ICT+FCT)	14,000	12	580 x 487 x 200	385 x 290
VA 2030/F/H/ GR2270/71	3802	Standard	TERADYNE	1-stage	9,000	8.5	483 x 391 x 103	345 x 215
VA 2130/F/H/ GR2270/71	4672	Tandem	TERADYNE	1-stage	2x 4,000	8.5	483 x 391 x 103	2x 130 x 220
VA 2040/F/H/ GR2270/71	3812	Standard	TERADYNE	1-stage	14,000	8.5	567 x 511 x 105	435 x 330
VA 2140/F/H/ GR2270/71	4673	Tandem	TERADYNE	1-stage	2x 6,000	8.5	567 x 511 x 105	2x 175 x 340
VA 2601-2e/F/H/ GR2270/71	13963	Standard	TERADYNE	2-stage (ICT+FCT)	14,000	12	567 x 511 x 109	385 x 290
VA 2030/F/H/ Pylon	4116	Standard	PYLON	1-stage	9,000	8.5	483 x 391 x 105	345 x 215

Description	Part number	Version	Test system interface	Contacting	Max. contact force [N]	Parallel stroke [mm]	Outer dimensions (W x D x H mm)	Typical usable area (W x D mm)
VA 2030/F/H/HG/ Pylon	31310	Tall housing	PYLON	1-stage	9,000	8.5	483 x 391 x 167	345 x 215
VA 2030/D/H/ Pylon	25818	Standard	PYLON	1-stage	9,000	8.5	530 x 375 x 150	345 x 215
VA 2130/F/H/ Pylon	13851	Tandem	PYLON	1-stage	2x 4,000	8.5	483 x 391 x 105	2x 130 x 220
VA 2130/F/H/HG/ Pylon	45641	- Tandem - Tall housing	PYLON	1-stage	2x 4,000	8.5	483 x 391 x 167	2x 130 x 220
VA 2130/D/H/ Pylon	15879	Tandem	PYLON	1-stage	2x 4,000	8.5	530 x 375 x 160	2x 130 x 220
VA 2501-2e/F/H/ Pylon	20977	Standard	PYLON	2-stage (ICT+FCT)	9,000	12	483 x 391 x 108	295 x 175
VA 2040/F/H/ Pylon	1226	Standard	PYLON	1-stage	14,000	8.5	568 x 511 x 105	435 x 330
VA 2040/F/H/HG/ Pylon	28738	Tall housing	PYLON	1-stage	14,000	8.5	580 x 511 x 167	435 x 330
VA 2040/D/H/ Pylon	15481	Standard	PYLON	1-stage	14,000	8.5	620 x 499 x 153	435 x 330
VA 2140/F/H/ Pylon	4759	Tandem	PYLON	1-stage	2x 6,000	8.5	568 x 511 x 105	2x 175 x 340
VA 2140/F/H/HG/ Pylon	32554	- Tandem - Tall housing	PYLON	1-stage	2x 6,000	8.5	580 x 511 x 167	2x 175 x 340
VA 2140/D/H/ Pylon	31426	Tandem	PYLON	1-stage	2x 6,000	8.5	620 x 499 x 163	2x 175 x 340
VA 2601-2e/F/H/ Pylon	16001	Standard	PYLON	2-stage (ICT+FCT)	14,000	12	568 x 511 x 108	385 x 290
VA 2060/F/H/ Pylon	35443	Standard	PYLON	1-stage	22,000	8.5	668 x 610 x 105	535 x 440
VA 2060/D/H/ Pylon	53615	Standard	PYLON	1-stage	22,000	8.5	718 x 610 x 220	535 x 440
VA 2060/F/H/ ITA-14	9939	Standard	ITA-14	1-stage	22,000	8.5	673 x 610 x 105	535 x 440
VA 2040/D/H/ VPC-G12	35615	Standard	VIRGINIA PANEL	1-stage	14,000	8.5	620 x 490 x 155	435 x 330
VA 2040/D/H/ VPC-G12	26639	Standard	VIRGINIA PANEL	1-stage	14,000	8.5	620 x 532 x 155	435 x 330
VA 2040/F/H/ VPC-G12	45487	Standard	VIRGINIA PANEL	1-stage	14,000	8.5	580 x 544 x 165	435 x 330
VA 2601-2e/D/H/ VPC-G12	47914	Standard	VIRGINIA PANEL	2-stage (ICT+FCT)	14,000	12	620 x 490 x 155	385 x 290
VA 2040/D/H/HG/ VPC-G12x-18	43184	Tall housing	VIRGINIA PANEL	1-stage	14,000	8.5	620 x 500 x 213	435 x 330
VA 2601-2e/D/H/HG/ VPC-G12x-18	47731	Tall housing	VIRGINIA PANEL	2-stage (ICT+FCT)	14,000	12	620 x 500 x 215	385 x 290

VA sizes	VA xxxx test fixture (without test system interface)		VA xxxx test fixture (with test system interface)							REINHARDT VG 12	SPEA 501
	Standard	Rigid pin	COBHAM (AEROFLEX) 4200/4210 	COBHAM (AEROFLEX) 4200/4250 	DIGITALTEST MTS 100 	DIGITALTEST MTS 200 	DIGITALTEST MTS 300 	KEYSIGHT i3070-5 			
Standard single-stage version											
VA 2020											20842
VA 2030	4753 4979	27735									
VA 2035										17293	
VA 2040	4982 4980	27737	20229 9904	30625	10932	4758	18000			12421	25338
VA 2050											
VA 2060	32352										
VA 2070S								4844-KIT 18131 101746 18084 18843 27005 30685 4998 27779 56930			
VA 2073L								8326 25517 25522			
Tandem single-stage version											
VA 2130	12699										
VA 2140	12700		12736				21629				35340
VA 2050T											
VA 2070ST								10319 27964			
Standard dual-stage version											
VA 2020-2e											20850
VA 2035-2e										34834	
VA 2501-2e											
VA 2601-2e			25754 18210				18510				44260
VA 2070S-2e								14251 18781 28715 28900			
VA 2073L-2e								37737			





# VA customisations

## Modular design suitable for every testing task

Thanks to the fixture's **modular design**, there are various ways to ensure the electronic unit makes contact with the spring-loaded test probes. A large variety of standardised **VA customisations**, such as PCB-specific sealing masks, vacuum

covers, pressure frame units or additional contact units are available to implement a complementary single-stage contacting from above. The customisations can be combined with almost all vacuum test fixtures in various sizes.

### VA customisations

#### Standardised units for mounting on the vacuum test fixture

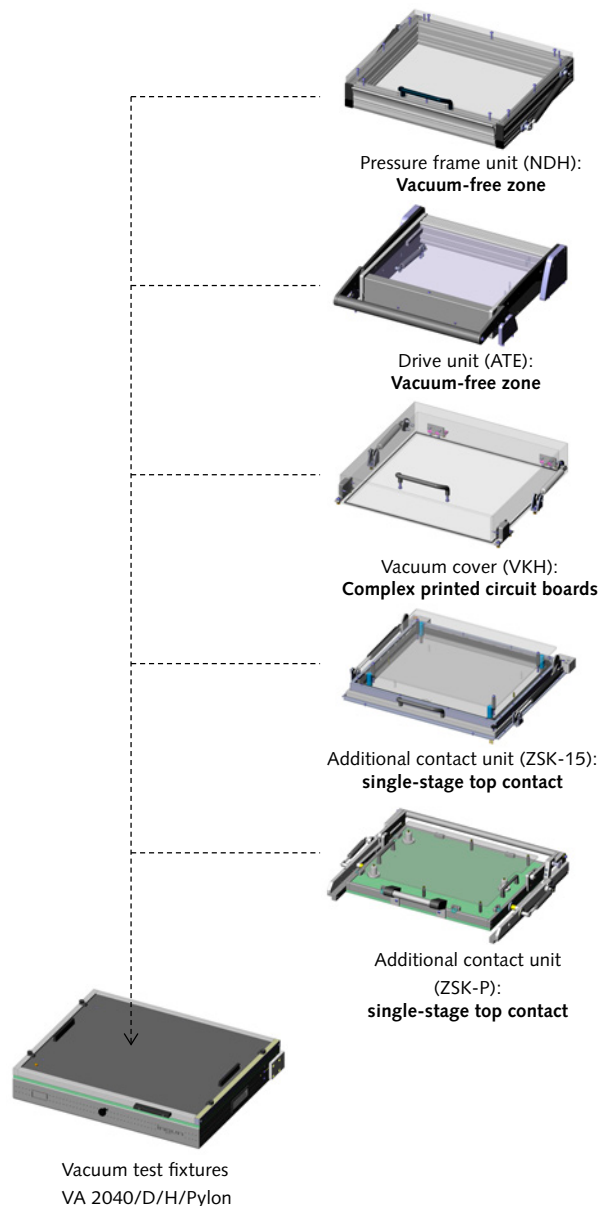

**Vacuum-free zone** test to contact the electronic unit under standard atmospheric conditions. Access to the electronic unit to be tested in the contacted state is possible by milling out the pressure frame plate.

**Vacuum-free zone** test to contact the electronic unit under standard atmosphere and for implementation of a complementary single-stage contact from above, if required. Access to the electronic unit to be tested in the contacted state is possible by milling out the pressure frame plate.

Testing of **complex printed circuit boards** with several openings and feedthroughs which cannot be sealed by means of a PCB-specific sealing mask. Contacting occurs under vacuum. Access to the electronic unit to be tested in the contacted state is not possible.

Test with complementary **single-stage contact from above**, if double-sided contacting (bottom and top) is required during testing of the electronic unit. Contacting occurs under vacuum. Access to the electronic unit to be tested in the contacted state is not possible.

Technical information at a glance

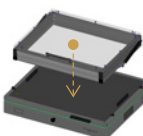
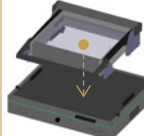
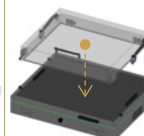
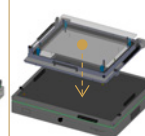
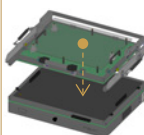
	Pressure frame unit (NDH)	Drive unit (ATE)	Vacuum cover (VKH)	Additional contact units (ZSK)	
				ZSK-VA2xxx-15	ZSK-VA2xxx-P
					
<b>Customisation</b>	Vacuum-free zone		Complex DUTs	Single-stage contacting from top side	
<b>Contacting</b>	Standard atmosphere			Vacuum	
<b>Access to DUT during contacting</b>	Possible			Not possible	
<b>Opening angle</b>	approx. 85 °	approx. 75 °	approx. 85 °		Parallel open
<b>Parallel stroke (mm)</b>	---	15	---	10	
<b>Pushrod length (mm)</b>	55.6	60	55.6	15 (8.4 mm sunk)	15
<b>Free overall height above PCB (mm)</b>	53.6	58	53.6	4.6	13
<b>GKS installation height, top (mm)</b>	---	16.0 (with optional functional unit only)	---	10.5	16.0

**Customisation accessories**

Pushrods, test piece supports, tooling pins, pre-centring pins and other accessories, such as marking units and test plugs, can be found from page 153 onwards.

**VA designs**

Pressure frame	134
Drive units	136
Vacuum covers	137
Additional contact units	
- ZSK-VA2xxx-15	138
- ZSK-VA2xxx-P	139

**Accessories**

Vacuum-free zones	135, 136
Mounting kit, single-stage	136
Top contacting	
Round sealing chord	137
Pore sealing multipoint connectors	138
Socket	139

**Note**

See page 140 for product overview.

## Pressure frame unit (NDH)

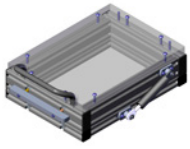

NDH-185-255-VK-ESD

- 15 mm, ESD-compliant pressure frame plate (NHP)
- 1x gas pressure spring 50 N (mounted externally, right)
- Locking latch

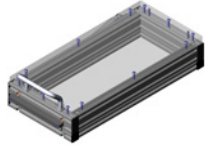

NDH-185-390-VK-ESD

- 15 mm, ESD-compliant pressure frame plate (NHP)
- 1x gas pressure spring 50 N (mounted externally, left)
- Locking latch

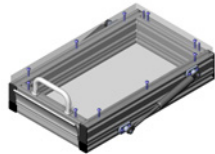

NDH-209-340-VL-ESD

- 15 mm, ESD-compliant pressure frame plate (NHP)
- 2x gas pressure spring 50 N (mounted externally)
- Locking bar

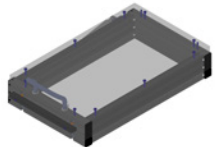

NDH-230-380-VK-ESD

- 15 mm, ESD-compliant pressure frame plate (NHP)
- 1x gas pressure spring 50 N (mounted externally, left)
- Locking latch

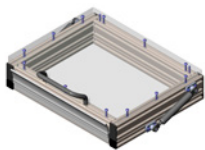

NDH-325-255-VL-ESD

- 15 mm, ESD-compliant pressure frame plate (NHP)
- 2x gas pressure spring 50 N (mounted externally)
- Locking bar

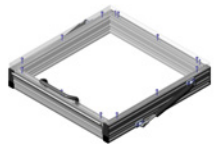

NDH-385-390-VL-ESD

- 15 mm, ESD-compliant pressure frame plate (NHP)
- 2x gas pressure spring 75 N (mounted externally)
- Locking bar

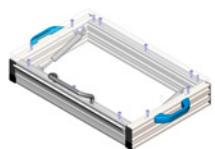

NDH-400-255-VL-ESD

- 15 mm, ESD-compliant pressure frame plate (NHP)
- 2x gas pressure spring 50 N (mounted internally)
- Locking bar
- 2x carrying handle

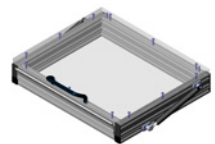

NDH-400-330-VL-ESD

- 15 mm, ESD-compliant pressure frame plate (NHP)
- 2x gas pressure spring 75 N (mounted externally)
- Locking bar

## Features

- For mounting on VA pressure plate (ADP)
- 15 mm thick pressure frame plate (NHP) made of ESD-compliant PVC or PMMA (transparent)
- Profile 20 mm thick
- Access to the DUT in the contacted state possible by milling out the pressure frame plate
- Manufacturing dimensions of vacuum seals for vacuum-free zones according to customer information

## Technical specifications

### Pressure frame

- Outer dimensions and inner width (W x D x H):

- NDH-185-255-VK-ESD:	approx. 210 x 288 x 100 mm
- NDH-185-390-VK-ESD:	approx. 145 x 215 x 60 mm
- NDH-209-340-VL-ESD:	approx. 210 x 423 x 115 mm
- NDH-230-380-VK-ESD:	approx. 145 x 350 x 60 mm
- NDH-325-255-VL-ESD:	approx. 250 x 360 x 103 mm
- NDH-385-390-VL-ESD:	approx. 168.5 x 300 x 60 mm
- NDH-400-255-VL-ESD:	approx. 256 x 413 x 115 mm
- NDH-400-330-VL-ESD:	approx. 190 x 340 x 60 mm
- NDH-480-390-VL-ESD:	approx. 367 x 288 x 100 mm
- NDH-535-480-VL-ESD:	approx. 285 x 215 x 60 mm
- NDH-700-390-VK-ESD:	approx. 430 x 423 x 100 mm
- Opening angle:	approx. 345 x 350 x 60 mm
- Pushrod length:	approx. 452 x 288 x 100 mm
- Free height above PCB:	approx. 310 x 215 x 60 mm
- Operating temperature range:	approx. 443 x 363 x 100 mm
	approx. 360 x 290 x 60 mm
	approx. 523 x 423 x 100 mm
	approx. 440 x 350 x 60 mm
	approx. 578 x 513 x 100 mm
	approx. 495 x 440 x 60 mm
	approx. 743 x 423 x 100 mm
	approx. 660 x 350 x 60 mm
	approx. 85°
	55.6 mm
	approx. 53.6 mm
	+ 10 °C to + 60 °C

## Pressure frame unit (NDH)

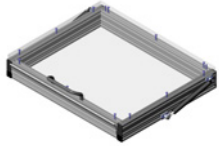

NDH-480-390-VL-ESD

- 15 mm, ESD-compliant pressure frame plate (NHP)
- 2x gas pressure spring 75 N (mounted externally)
- Locking bar

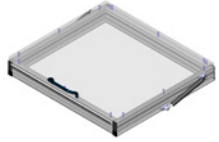

NDH-535-480-VL-ESD

- 15 mm, ESD-compliant pressure frame plate (NHP)
- 2x gas pressure spring 75 N (mounted externally)
- Locking bar

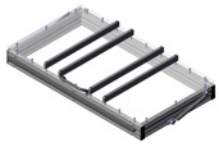

NDH-700-390-VK-ESD

- 15 mm, ESD-compliant pressure frame plate (NHP)
- 2x gas pressure spring 100 N (mounted externally)
- Locking bar
- 4x stiffener bar

## Compatible with vacuum stand-alone test fixture

### Vacuum test fixture

- VA 2020 | VA 2020-2e:
- VA 2030 | VA 2501-2e:
- VA 2035 | VA 2035-2e:
- VA 2040 | VA 2601-2e:
- VA 2050:
- VA 2060:
- VA 2070S | VA 2070S-2e:
- VA 2070SR:
- VA 2073L | VA 2073L-2e:
- VA 2130:
- VA 2140:
- VA 2050T:
- VA 2070ST:

### Pressure frame

- Part 32247, 34301, 33884, 32979
- Part 33884, 32979, 19997
- Part 32979, 34301, 19997
- Part 32224, 33607, 32247, 33884
- Part 33607, 32247, 33884, 32979
- Part 35476, 32224, 33607, 32247
- Part 33607, 17985, 15972, 34301
- Part 19997, 32979
- Part 17696, 32224, 33607, 32247
- Part 19997
- Part 17985, 15972, 34301, 19997
- Part 15972, 19997
- Part 15972, 19997

## Ordering information

Pressure frame units (NDH)		
Part no.: 19997	NDH-185-255-VK-ESD	15 mm, ESD-compliant NHP, 1x gas pressure spring 50 N, locking bar
Part no.: 15972	NDH-185-390-VK-ESD	15 mm, ESD-compliant NHP, 1x gas pressure spring 50 N, locking bar
Part no.: 34301	NDH-209-340-VL-ESD	15 mm, ESD-compliant NHP, 2x gas pressure spring 50 N, locking bar
Part no.: 17985	NDH-230-380-VK-ESD	15 mm, ESD-compliant NHP, 1x gas pressure spring 50 N, locking bar
Part no.: 32979	NDH-325-255-VL-ESD	15 mm, ESD-compliant NHP, 2x gas pressure spring 50 N, locking bar
Part no.: 33607	NDH-385-390-VL-ESD	15 mm, ESD-compliant NHP, 2x gas pressure spring 75 N, locking bar
Part no.: 33884	NDH-400-255-VL-ESD	15 mm, ESD-compliant NHP, 2x gas pressure spring 50 N, locking bar, 2x carrying handle
Part no.: 32247	NDH-400-330-VL-ESD	15 mm, ESD-compliant NHP, 2x gas pressure spring 75 N, locking bar
Part no.: 32224	NDH-480-390-VL-ESD	15 mm, ESD-compliant NHP, 2x gas pressure spring 75 N, locking bar
Part no.: 35476	NDH-535-480-VL-ESD	15 mm, ESD-compliant NHP, 2x gas pressure spring 75 N, locking bar
Part no.: 17696	NDH-700-390-VK-ESD	15 mm, ESD-compliant NHP, 2x gas pressure spring 100 N, locking bar, 4x stiffener bar
Vacuum seals for vacuum-free zones		
Part no.: 46794	VD-Z-XXX-XXX	Single-stage vacuum silicone seal, height = 15 mm, width and depth variable
Part no.: 46795	VD-Z-XXX-XXX-2	Dual-stage vacuum silicone seal, height = 19 mm, width and depth variable



## Drive units (ATE)

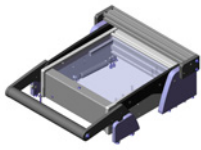

ATE VA2030/small

- 15 mm, ESD-compliant pressure frame plate (NHP)
- 2x gas pressure spring 100 N (left) / 50 N (right)

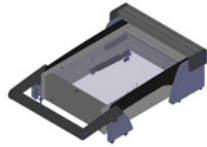

ATE VA2040/small

- 15 mm, ESD-compliant pressure frame plate (NHP)
- 2x gas pressure spring 100 N (left) / 200 N (right)

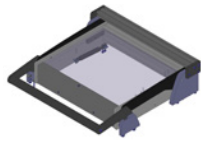

ATE VA2040

- 15 mm, ESD-compliant pressure frame plate (NHP)
- 2x gas pressure spring 100 N (left) / 200 N (right)

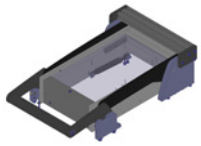

ATE VA2140/2160

- 15 mm, ESD-compliant pressure frame plate (NHP)
- 2x gas pressure spring 100 N (left) / 200 N (right)

## Features

- For mounting on VA pressure plate (ADP), incl. mounting material
- 15 mm thick pressure frame plate (NHP) made of ESD-complaint acrylic glass (transparent)
- Incl. drive unit closed check with stroke switch (soldered connection)
- Incl. mechanical drive unit locking
- Access to the DUT in the contacted state possible by milling in the pressure frame plate
- Manufacturing dimensions of vacuum seals for vacuum-free zones according to customer information
- Single-sided manual single-stage contact from top, only with functional unit (FB)

## Technical specifications

### Drive units

- Outer dimensions (W x D x H) and usable area (W x D):
  - ATE VA2030/small: approx. 292 x 384 x 101 mm  
approx. 180 x 190 mm
  - ATE VA2040/small: approx. 292 x 454 x 101 mm  
approx. 180 x 260 mm
  - ATE VA2040: approx. 432 x 454 x 101 mm  
approx. 320 x 260 mm
  - ATE VA2140/2160: approx. 250 x 454 x 101 mm  
approx. 135 x 260 mm
- Opening angle: approx. 75 °
- Pushrod length: 60 mm
- Free height above PCB: approx. 58 mm
- GKS installation height, top: 16.0 mm
- GKS theoretical working stroke: 3.5 mm (top)
- Operating temperature range: + 10 °C to + 60 °C

## Commissioning ATE VA2xx0

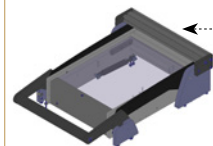

Transport guard

- Remove before commissioning
- Cover open threaded holes with perforated M4 plugs

## Compatible with vacuum stand-alone test fixture

### Vacuum test fixture

VA 2020 | VA 2020-2e:  
VA 2030 | VA 2501-2e:  
VA 2035 | VA 2035-2e:  
VA 2040 | VA 2601-2e:  
VA 2050:  
VA 2060:  
VA 2070S | VA 2070S-2e:  
VA 2070SR:  
VA 2073L | VA 2073L-2e:  
VA 2130:  
VA 2140:  
VA 2050T:  
VA 2070ST:

### Drive units

Part 49265, 49395, 51305, 49465  
Part 51305  
Part 49395, 51305, 49465  
Part 49265, 49395, 51305, 49465  
Part 49265, 49395, 51305, 49465  
Part 49265, 49395, 51305, 49465  
Part 49395, 51305, 49465  
-  
Part 49265, 49395, 51305, 49465  
-  
Part 49465  
-  
-

## Note:

Mounting kits for single-stage top contacting can be found on page 75.

## Ordering information

Drive units (ATE VA2xxx)		
Part no.:	51305	ATE VA2030/small
Part no.:	49395	ATE VA2040/small
Part no.:	49265	ATE VA2040
Part no.:	49465	ATE VA2140/2160

Vacuum seals for vacuum-free zones		
Part no.:	46794	VD-Z-XXX-XXX
Part no.:	46795	VD-Z-XXX-XXX-2

Vacuum covers (VKH)

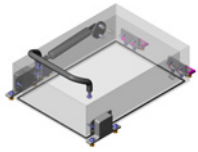

- ESD version
- Wall thickness: 12 mm
- 1x gas pressure spring (left)
- 2x snap-on fastener, 13 N retention force

VKH-175-245-72-12-ESD

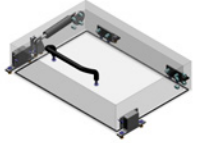

- ESD version
- Wall thickness: 12 mm
- 1x gas pressure spring (left)
- 2x snap-on fastener, 13 N retention force

VKH-300-215-72-12-ESD

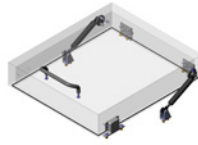

- ESD version
- Wall thickness: 15 mm
- 2x gas pressure spring
- 1x snap-on fastener, 13 N retention force (right)

VKH-340-390-75-15-ESD



- ESD version
- Wall thickness: 15 mm
- 1x gas pressure spring (right)
- 1x snap-on fastener, 13 N retention force (right)

VKH-370-220-75-15-ESD

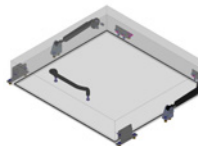

- ESD version
- Wall thickness: 15 mm
- 2x gas pressure spring
- 2x snap-on fastener, 13 N retention force

VKH-390-360-75-15-ESD

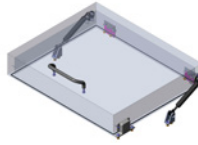

- ESD version
- Wall thickness: 15 mm
- 2x gas pressure spring
- 1x snap-on fastener, 13 N retention force (right)

VKH-430-360-75-15-ESD

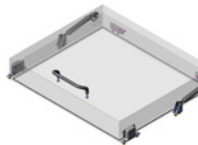

- ESD version
- Wall thickness: 15 mm
- 2x gas pressure spring
- 2x snap-on fastener, 13 N retention force

VKH-460-390-75-15-ESD

Features

- For mounting on VA pressure plate (ADP), incl. mounting material
- ESD-compliant vacuum cover (transparent)
- Wall thickness: 12 mm or 15 mm

Technical specifications

Vacuum cover

- Outer dimensions and inner width (W x D x H):
  - VKH-175-245-72-12-ESD: approx. 175 x 245 x 72 mm
  - VKH-300-215-72-12-ESD: approx. 151 x 221 x 60 mm
  - VKH-340-390-75-15-ESD: approx. 300 x 215 x 72 mm
  - VKH-370-220-75-15-ESD: approx. 276 x 191 x 60 mm
  - VKH-390-360-75-15-ESD: approx. 340 x 390 x 75 mm
  - VKH-430-360-75-15-ESD: approx. 310 x 360 x 60 mm
  - VKH-460-390-75-15-ESD: approx. 370 x 220 x 75 mm
  - VKH-390-360-75-15-ESD: approx. 340 x 190 x 60 mm
  - VKH-430-360-75-15-ESD: approx. 390 x 360 x 75 mm
  - VKH-460-390-75-15-ESD: approx. 360 x 330 x 60 mm
  - VKH-430-360-75-15-ESD: approx. 430 x 360 x 75 mm
  - VKH-460-390-75-15-ESD: approx. 400 x 330 x 60 mm
  - VKH-430-360-75-15-ESD: approx. 460 x 390 x 75 mm
  - VKH-460-390-75-15-ESD: approx. 430 x 360 x 60 mm
- Opening angle: approx. 85°
- Snap-on fastener retention force: 13 N
- Pushrod length: 55.6 mm
- Free height above PCB: approx. 53.6 mm
- Operating temperature range: + 10 °C to + 60 °C

Compatible with vacuum stand-alone test fixture

Vacuum test fixture

- VA 2020 | VA 2020-2e:
- VA 2030 | VA 2501-2e:
- VA 2035 | VA 2035-2e:
- VA 2040 | VA 2601-2e:
- VA 2050:
- VA 2060:
- VA 2070S | VA 2070S-2e:
- VA 2070SR:
- VA 2073L | VA 2073L-2e:
- VA 2130:
- VA 2140:
- VA 2050T:
- VA 2070ST:

Vacuum cover

- Part 15535, 15533, 17469
- Part 15535, 15533, 17469
- Part 15533, 17469
- Part 18394, 19252, 17560, 15534
- Part 15534, 17560, 15535, 15533
- Part 18394, 19252, 17560, 15534
- Part 17560, 15533, 17469
- Part 17469, 15533
- Part 18394, 19252, 15534, 17560
- Part 17469
- Part 17469
- Part 17469
- Part 17469

Ordering information

Vacuum covers (VKH)		
Part no.: 17469	VKH-175-245-72-12-ESD	ESD, 12 mm, 1x gas pressure spring (left), 2x snap-on fastener 13 N
Part no.: 15533	VKH-300-215-72-12-ESD	ESD, 12 mm, 1x gas pressure spring (left), 2x snap-on fastener 13 N
Part no.: 17560	VKH-340-390-75-15-ESD	ESD, 15 mm, 2x gas pressure spring, 1x snap-on fastener 13 N (right)
Part no.: 15535	VKH-370-220-75-15-ESD	ESD, 15 mm, 1x gas pressure spring (right), 1x snap-on fastener 13 N (right)
Part no.: 15534	VKH-390-360-75-15-ESD	ESD, 15 mm, 2x gas pressure spring, 2x snap-on fastener 13 N
Part no.: 19252	VKH-430-360-75-15-ESD	ESD, 15 mm, 2x gas pressure spring, 1x snap-on fastener 13 N (right)
Part no.: 18394	VKH-460-390-75-15-ESD	ESD, 15 mm, 2x gas pressure spring, 2x snap-on fastener 13 N

Accessories		
Part no.: 5107	Round sealing chord	Moos rubber, black, Ø 3 mm, per 5 m

## Additional contact units (ZSK)

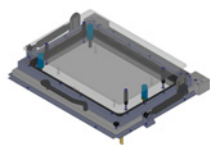

ZSK-VA2030-15

- 15 mm thickness, ESD-compliant KTP
- 3x precision guide
- 2x gas pressure spring 50 N

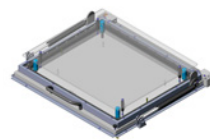

ZSK-VA2040-15

- 15 mm thickness, ESD-compliant KTP
- 4x precision guide
- 2x gas pressure spring 75 N

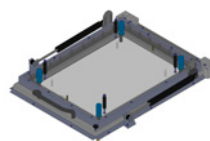

ZSK-VA2070-15

- 15 mm thickness, ESD-compliant KTP
- 4x precision guide
- 2x gas pressure spring 75 N

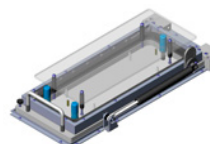

ZSK-VA2171-15

- 15 mm thickness, ESD-compliant KTP
- 3x precision guide
- 1x gas pressure spring 75 N

## Features

- For mounting on VA pressure plate (ADP), incl. mounting material
- Floating mount, 15 mm thick probe plate (KTP) made of ESD-compliant PVC (transparent)
- Incl. finger guard frame
- Incl. closed additional contact unit (ZSK) check with two GKS-114 in KS-113 23
- Incl. captive knurled screw for secure transportation
- Incl. adjustable gas pressure spring holder in 5 mm grid
- Single-sided vacuum operated single-stage contacting from top

## Technical specifications

### Additional contact units

- Outer dimensions (W x D x H) and usable area (W x D):
  - ZSK-VA2030-15: approx. 400 x 312 x 75 mm  
approx. 234 x 160 mm
  - ZSK-VA2040-15: approx. 489 x 434 x 75 mm  
approx. 325 x 300 mm
  - ZSK-VA2070-15: approx. 360 x 444 x 75 mm  
approx. 189 x 290 mm
  - ZSK-VA2171-15: approx. 201 x 427 x 75 mm  
approx. 100 x 260 mm
- Opening angle: approx. 85 °
- Pushrod length: 15 mm  
(sunk: 6.8 + 1.6 mm PCB thickness)

- Free height above PCB: approx. 4.6 mm
- GKS installation height, top: 10.5 mm
- GKS theoretical working stroke: 4.3 mm (top)
- Operating temperature range: + 10 °C to + 60 °C

### Compatible with vacuum stand-alone test fixture

Vacuum test fixture	Additional contact units
VA 2020   VA 2020-2e:	Part 34546
VA 2030   VA 2501-2e:	Part 34546
VA 2035   VA 2035-2e:	-
VA 2040   VA 2601-2e:	Part 34597, 34546
VA 2050:	Part 33550, 34546, 43070
VA 2060:	Part 34597, 34546, 33550, 43070
VA 2070S   VA 2070S-2e:	Part 33550, 43070
VA 2070SR:	-
VA 2073L   VA 2073L-2e:	Part 34597, 34546, 33550, 43070
VA 2130:	-
VA 2140:	-
VA 2050T:	Part 43070
VA 2070ST:	Part 43070

## Ordering information

Additional contact units (ZSK-VA2xxx-15)			
Part no.:	34546	ZSK-VA2030-15	15 mm, ESD-compliant KTP, 3x precision guide, 2x gas pressure spring 50 N
Part no.:	34597	ZSK-VA2040-15	15 mm, ESD-compliant KTP, 4x precision guide, 2x gas pressure spring 75 N
Part no.:	33550	ZSK-VA2070-15	15 mm, ESD-compliant KTP, 4x precision guide, 2x gas pressure spring 75 N
Part no.:	43070	ZSK-VA2171-15	15 mm, ESD-compliant KTP, 3x precision guide, 1x gas pressure spring 75 N

Accessories			
Part no.:	14282	Pore sealing strips	14 x 10 mm (H x B), height deviation: 12 - 13.5 mm, per 1 m

## Additional contact units (ZSK)

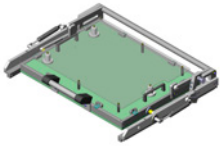

ZSK-VA2040-10-P

- 10 mm thick probe plate (KTP) made of FR4
- 3x precision guide
- 2x gas pressure spring 100 N

## Features

- For mounting on VA probe plate (KTP)
- Floating, precision-guided, 10 mm thick probe plate made of FR4
- Wiring protection plate made of ESD-compliant acrylic glass (transparent)
- Incl. circumferential vacuum seal
- Incl. locking bolts for secure transportation
- Single-sided vacuum operated single-stage contacting from top

## Exchangeable kit (ATS) for ZSK2070

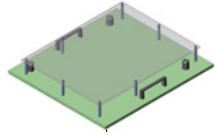

ATS ZSK2070

- 10 mm thick probe plate (KTP) made of FR4
- 3x precision guide

## Additional contact ZSK2070

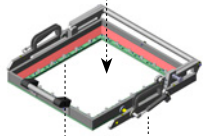

ZSK-VA2070-P

- Without ATS ZSK2070
- Without socket (left/right)
- 2x gas pressure spring 100 N



- Socket (left/right)

## Technical specifications

### Additional contact units

- Outer dimensions (W x D x H) and usable area (W x D):
  - ZSK-VA2040-10-P: approx. 650 x 470 x 102 mm  
approx. 340 x 270 mm
  - ZSK-VA2070-P: approx. 567 x 539 x 91 mm  
(with ATS ZSK2070)
  - ZSK-VA2073-P: approx. 280 x 350 mm  
(with ATS ZSK2073)
  - ZSK-VA2073-P: approx. 928 x 539 x 91 mm  
(with ATS ZSK2073)
  - ZSK-VA2073-P: approx. 630 x 350 mm  
(with ATS ZSK2073)
- Opening angle: parallel open (front, insertion length approx. 150 mm)
- Pushrod length: 15 mm
- Free height above PCB: approx. 13.0 mm
- GKS installation height, top: 16 mm
- GKS theoretical working stroke: 4.3 mm (top)
- Operating temperature range: + 10 °C to + 60 °C

## Exchangeable kit (ATS) for ZSK2073

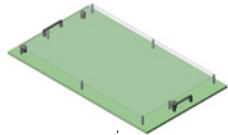

ATS ZSK2073

- 10 mm thick probe plate (KTP) made of FR4
- 3x precision guide

## Additional contact ZSK2073

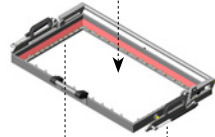

ZSK-VA2073-P

- Without ATS ZSK2073
- Without socket (left/right)
- 2x gas pressure spring 150 N



- Socket (left/right)

## Compatible with vacuum stand-alone test fixture

Vacuum test fixture	Additional contact units
VA 2020   VA 2020-2e:	-
VA 2030   VA 2501-2e:	-
VA 2035   VA 2035-2e:	-
VA 2040   VA 2601-2e:	Part 31182
VA 2050:	-
VA 2060:	-
VA 2070S   VA 2070S-2e:	Part 31291
VA 2070SR:	-
VA 2073L   VA 2073L-2e:	Part 35361
VA 2130:	-
VA 2140:	-
VA 2050T:	-
VA 2070ST:	-

## Ordering information

Additional contact units (ZSK-VA2xxx-P) and suitable exchangeable kits		
Part no.:	31182	ZSK-VA2040-10-P   10 mm KTP made of FR4, 3x precision guide, 2x gas pressure spring 100 N
Part no.:	31294	ATS ZSK2070   Exchangeable kit, 10 mm KTP made of FR4, 3x precision guide
Part no.:	31291	ZSK-VA2070-P   Additional contact unit without exchangeable kit, 2x gas pressure spring 100 N
Part no.:	33536	ATS ZSK2073   Exchangeable kit, 10 mm KTP made of FR4, 3x precision guide
Part no.:	35361	ZSK-VA2073-P   Additional contact unit without exchangeable kit, 2x gas pressure spring 150 N

Accessories		
Part no.:	18175	Socket, left   Mounting socket, left, compatible with ZSK-VA2070-P / ZSK-VA2073-P
Part no.:	18174	Socket, right   Mounting socket, right, compatible with ZSK-VA2070-P / ZSK-VA2073-P

Vacuum test fixture	Pressure frame units (NDH)	Drive units (ATE)	Vacuum covers (VKH)	Additional contact units (ZSK)	
				ZSK-VA2xxx-15	ZSK-VA2xxx-P
<b>Standard single-stage version</b>					
<b>VA 2020</b>	32247, 34301, 33884, 32979	49265, 49395, 51305, 49465	15535, 15533, 17469	34546	-
<b>VA 2030</b>	33884, 32979, 19997	51305	15535, 15533, 17469	34546	-
<b>VA 2035</b>	32979, 34301, 19997	49395, 51305, 49465	15533, 17469	-	-
<b>VA 2040</b>	32224, 33607, 32247, 33884	49265, 49395, 51305, 49465	18394, 19252, 17560, 15534	34597, 34546	31182
<b>VA 2050</b>	33607, 32247, 33884, 32979	49265, 49395, 51305, 49465	15534, 17560, 15535, 15533	33550, 34546, 43070	-
<b>VA 2060</b>	35476, 32224, 33607, 32247	49265, 49395, 51305, 49465	18394, 19252, 17560, 15534	34597, 34546, 33550, 43070	-
<b>VA 2070S</b>	33607, 17985, 15972, 34301	49395, 51305, 49465	17560, 15533, 17469	33550, 43070	31291
<b>VA 2070SR</b>	19997, 32979	-	17469, 15533	-	-
<b>VA 2073L</b>	17696, 32224, 33607, 32247	49265, 49395, 51305, 49465	18394, 19252, 15534, 17560	34597, 34546, 33550, 43070	35361
<b>Tandem single-stage version</b>					
<b>VA 2130</b>	19997	-	17469	-	-
<b>VA 2140</b>	17985, 15972, 34301, 19997	49465	17469	-	-
<b>VA 2050T</b>	15972, 19997	-	17469	43070	-
<b>VA 2070ST</b>	15972, 19997	-	17469	43070	-
<b>Standard dual-stage version</b>					
<b>VA 2020-2e</b>	32247, 34301, 33884, 32979	49265, 49395, 51305, 49465	15535, 15533, 17469	34546	-
<b>VA 2035-2e</b>	32979, 34301, 19997	49395, 51305, 49465	15533, 17469	-	-
<b>VA 2501-2e</b>	33884, 32979, 19997	51305	15535, 15533, 17469	34546	-
<b>VA 2601-2e</b>	32224, 33607, 32247, 33884	49265, 49395, 51305, 49465	18394, 19252, 17560, 15534	34597, 34546	31182
<b>VA 2070S-2e</b>	33607, 17985, 15972, 34301	49395, 51305, 49465	17560, 15533, 17469	33550, 43070	31291
<b>VA 2073L-2e</b>	17696, 32224, 33607, 32247	49265, 49395, 51305, 49465	18394, 19252, 15534, 17560	34597, 34546, 33550, 43070	35361



# Inline Interchangeable kits (WS)

Inline Interchangeable kits for

- KABTEC
- KEYSIGHT
- KONRAD
- SPEA



# Interchangeable kits Compatible with common inline test systems

**Interchangeable kits (WS)** are modular in design. They consist of a **interchangeable kit bottom part (WSU)** and a **interchangeable kit top part (WSO)**. They can be mounted quickly and easily in a few simple steps, and impress with their robust design for reliable, consistent contacting in the inline test system.  
Interchangeable kits are not fully functional test fixtures in their own right. They do not have their own lifting

mechanism, so that they cannot generate their own contacting stroke. The contacting stroke is generated by the inline test system in which the interchangeable kit is used.  
**Inline test systems** are primarily part of a fully automatic production line featuring the various processes necessary for printed circuit board production. The electrical test (ICT/FCT) for checking the finished printed circuit boards is carried out in the inline test system.

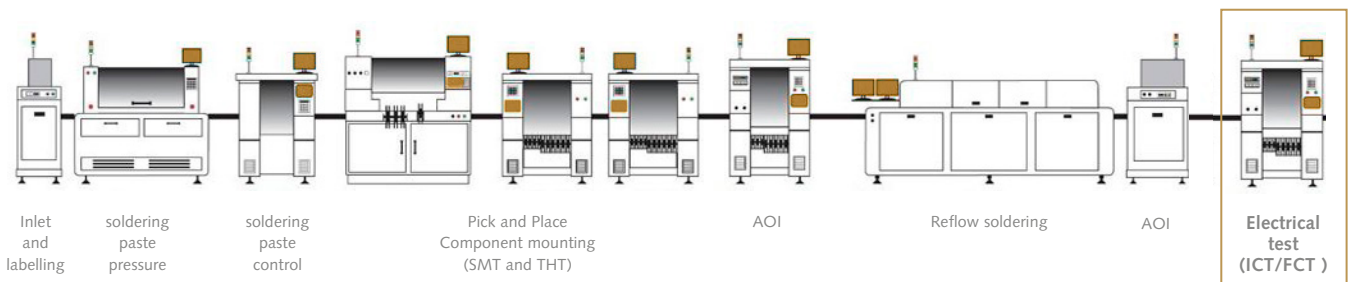



Example of a fully automated production line for printed circuit board production (inline)

Benefit from our many years of experience and our extensive product portfolio. INGUN offers standardised interchangeable kits for common inline test systems from well-known test system manufacturers, such as Keysight.

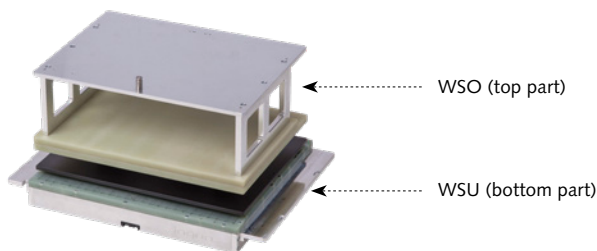
### KEYSIGHT Inline Test Systems Medalist

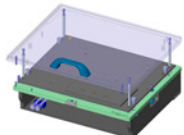
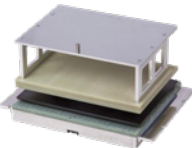
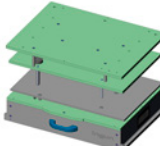
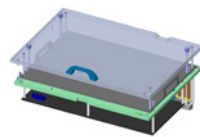
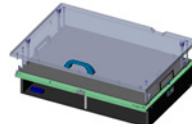

Interchangeable kit WS Keysight/i3070-5i

Models
 ATS MA12/S-7/Kabtec
 WS Keysight/i3070-5i
 WS Keysight/i1000D
 ATS MA13/16xVG/Konrad
 ATS MA13/S-10/Konrad
 WS SPEA/3030/Inline

**Usage**

**Interchangeable kits (WS) and/or exchangeable kits (ATS)** are suitable for contacting high-volume electronic units such as printed circuit boards (PCBs) (mass testing) and a small number of versions. They are installed in an existing inline test system and can be used for one-way, two-way or dual-stage contacting to perform the combined ICT/FCT test.

**Features**

- Robust design
- Modular design with interchangeable kit bottom part (WSU or KTE) and interchangeable kit top part (WSO or NDH)
- Bend-resistant probe plate made of FR4
- Can be used for single-sided, single / dual-stage or double-sided, single-stage contacting

**Life span**

- > 2,000,000 load cycles (laboratory conditions)  
 The life span is determined in the laboratory with fully automatic, computer-controlled endurance test stations under full load. Since the life span depends on many different factors and in particular on the individual test application, INGUN does not guarantee the actual duration of use in the test field.

**Customising**

Pushrods, test piece supports, tooling pins, pre-centring pins and other accessories, such as marking units and test plugs, can be found from page 153 onwards.

Interchangeable kits/  
exchangeable kits  
for inline test systems

Exchangeable kits for  
KABTEC test systems  
ATS MA12/... 144

Interchangeable kits for  
KEYSIGHT test systems  
WS Keysight/... 145

Exchangeable kits for  
KONRAD test systems  
ATS MA13/... 146

Interchangeable kits for  
SPEA test systems  
WS SPEA/3030/... 147

**Note**

See page 148 for overview and comparison table.

## Exchangeable kits ATS MA12/S-7 for high volume tests in KABTEC Inline test systems KT1000i

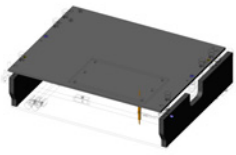

- 1x moving plate
- 2x side parts
- 2x countersunk M4 x 12 screw
- 1x KS-364 23
- 1x SKS-419 305 150 A 1808 S05

Upgrade kit  
ARS-KABTEC-ATSMA12/S-7

to upgrade exchangeable kit ATS MA12/S-7

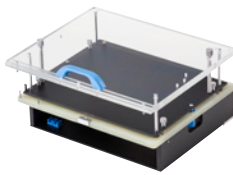

Standard exchangeable kit  
with internal interface  
ATS MA12/S-7

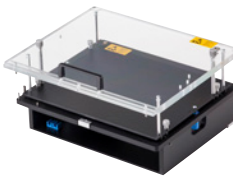

ESD exchangeable kit  
with internal interface  
ATS MA12/S-7/ESD

Example:

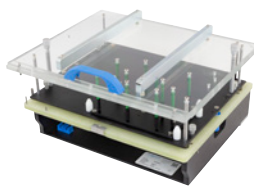

Customised  
ATS MA12/S-7/KABTEC  
with optional stiffener bars

### Features

- Upgrade kit can be combined with standard & ESD exchangeable kits
- Incl. 1 switching probe (SKS) to detect the position and alignment of the PCB. The position detection is mounted on the test system side.
- 10 mm bend resistant probe plate made of FR4
- 4 mm ESD-complaint, precision-guided moving plate and 4 mm probe guard plate
- Single-sided, double-sided, or dual-stage contacting

### Technical specifications

#### Exchangeable kit ATS MA12/S-7/Kabtec

(ATS MA12/S-7 upgraded with upgrade kit ARS-KABTEC-ATSMA12/S-7)

- Outer dimensions (W x D x H): approx. 350 x 313 x 203 mm
- Useable area (W x D): approx. 285 x 240 mm
- Number of VG male connectors: max. 7
- Free height above PCB: approx. 53.6 mm
- Pushrod length: 55.6 mm
- GKS installation height, bottom: 16.0 mm
- GKS installation height, top: 16.0 mm
- GKS installation height, 2-stage, bottom: 16.0 | 21.5 mm
- GKS theoretical working stroke: 3.1 mm (bottom), 3.7 mm (top)
- Operating temperature range: + 10 °C to + 60 °C

#### Test system interface

- ATS MA12/S-7/Kabtec: max. 7 interface blocks SB-P (DUT side) for max. 1,190 signals (not included), e.g.

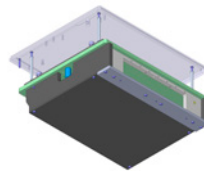

#### Note:

Suitable interface blocks for mounting the interface can be found starting on page 155.

#### Note:

INGUN provides customising documents for customisation. The exchangeable kits are customised according to customising guidelines **info 4065**.

#### Note:

When used in the KABTEC inline test system KT1000i, the contacting stroke of the exchangeable kit is approx. 0.4 mm longer than usual. Therefore, the test probe stroke is approx. 0.4 mm longer and there is approx. 0.4 mm less space under the moving plate.

## Ordering information

Upgrade kit ARS-KABTEC-ATSMA12/S-7 to customise exchangeable kit ATS MA12/S-7		
Part no.: 101865	ARS-KABTEC-ATSMA12/S-7	Upgrade kit, incl. 1x switching probe (SKS), e.g. to check PCB position
Accessories for ATS MA12/S-7		
Part no.: 45903-KIT	ATS MA12/S-7	Standard exchangeable kit with internal interface
Part no.: 46236-KIT	ATS MA12/S-7/ESD	ESD exchangeable kit with internal interface

Parts with the ending "-KIT" are delivered unassembled. This enables immediate DUT-specific processing.

**Interchangeable Kit WS Keysight / i3070-5i**  
for high volume tests in  
KEYSIGHT test system **MEDALIST i3070-5i**

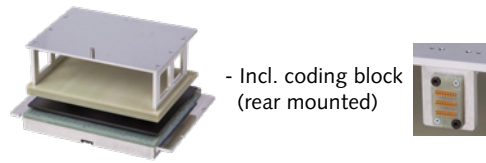

WS Keysight/i3070-5i consists of:

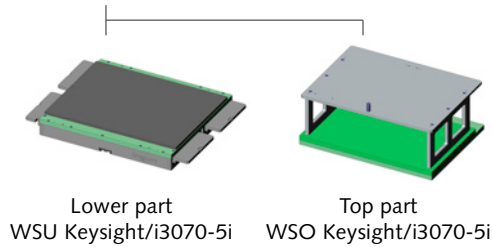

**Interchangeable kit WS Keysight/i1000D**  
for high volume tests in  
KEYSIGHT test system **MEDALIST i1000D**

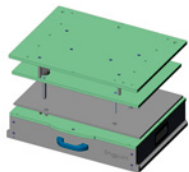

WS Keysight/i1000D consists of:

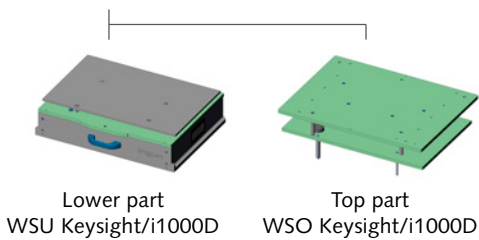

**Features**

- Bend-resistant probe plate made of FR4
- ESD-compliant, precision-guided DUT support
- Includes pressure plate, guide posts and guide bushings (supplied loose) and coding block for WSO Keysight/i3070-5i
- Single-sided, single / dual-stage, or double-sided, single-stage contacting

**Technical specifications**

**Interchangeable kits**

- Outer dimensions, closed (W x D x H):
  - WS Keysight/i3070-5i: approx. 566 x 403 x 278 mm
  - WSU Keysight/i3070-5i: approx. 566 x 403 x 65 mm
  - WSO Keysight/i3070-5i: approx. 455 x 341 x 197 mm
  - WSU Keysight/i1000D: approx. 470 x 369 x 125 mm
  - WSO Keysight/i1000D: approx. 459 x 340 x 167 mm
- Usable area (W x D):
  - WSU Keysight/i3070-5i: approx. 405 x 341 mm
  - WSU Keysight/i1000D: approx. 390 x 280 mm
- GKS installation height, bottom:
  - WSU Keysight/i3070-5i: 16.0 mm (WS-i3070-5i)
  - WSO Keysight/i1000D: 13.0 mm (WS-i1000D)
- GKS installation height, top: 16.0 mm
- GKS installation height, 2-stage, bottom: 16.0 | 21.5 mm (WS-i3070-5i) / 13.0 | 18.3 mm (WS-i1000D)
- GKS theoretical working stroke: 4.0 mm (bottom), 4.0 mm (top)
- Operating temperature range: + 10 °C to + 60 °C

**Test system interface (unloaded)**

- i3070-5i: max. 3,666 personality pins (see page 106)
- i1000D: max. 42 VG clip connectors (64 pole) for 2,688 signals (see page 205)



**Further information**

	WS Keysight/i3070-5i	WS Keysight/i1000D
Pushrod length	20 mm (4 mm countersunk)	60 mm
Free height above PCB	11 mm	58 mm

**Note:**

INGUN provides customising documents for customisation. The interchangeable kit WS Keysight/i3070-5i are customised according to customising guidelines **info 1690** and the interchangeable kit Keysight/i1000D are customised according to customising guidelines **info 2270**. Keysight Opens Test components can be found on pages 106 to 108.

## Ordering information

Inline interchangeable kits		
Part no.: 48136-KIT	WS Keysight/i3070-5i	Interchangeable kit, complete, for test systems i3070-5i, KTP made of FR4
Part no.: 103042-KIT	WSU Keysight/i3070-5i	Interchangeable kit, bottom, for test systems i3070-5i, KTP made of FR4
Part no.: 103045-KIT	WSO Keysight/i3070-5i	Interchangeable kit, top, for test systems i3070-5i, NHP made of FR4
Part no.: 53790	WSU Keysight/i1000D	Interchangeable kit, top, for test systems i1000D, KTP made of FR4
Part no.: 53910	WSO Keysight/i1000D	Interchangeable kit top part for test systems i1000D, NHP made of FR4

Accessories for WS Keysight/i3070-5i		
Part no.: 48160	Spacer	Spacer (L = 133 mm, D = 10 mm)
Part no.: 48137	Stroke counter	Sum counter Omron H7EC-N incl. fixing bracket
Part no.: 100811	MAP WSU/Keysight/i3070-5i	Earthing plate with imprint
Part no.: 101615	FB-ABF-A-O-10V	PCB correct position check

Parts with the ending "-KIT" are delivered unassembled. This enables immediate DUT-specific processing.



**Exchangeable kits ATS MA13/.../Konrad for high volume tests in KONRAD test systems LEON INLINE TINY**

**ATS MA13/16xVG/Konrad**  
Test system connection via **VG multi-point connectors**

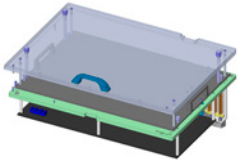

Front view

- Fully loaded, incl. 16x VG-male connectors (96-pin)

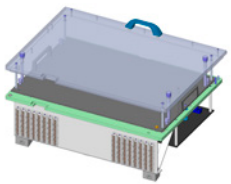

Rear view

**ATS MA13/S-10/Konrad**  
Test system connection via **interface blocks**

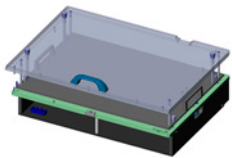

Front view

- Unloaded, prepared for up to 10x interface blocks

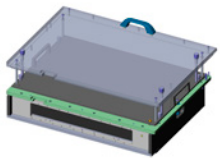

Rear view

**Features**

- Modular design
- 10 mm thick bend-resistant probe plate made of FR4
- ESD-compliant, precision-guided pressure plate
- Test system connection via VG multi-point connectors or via interface blocks
- Single-sided, double-sided, dual-stage contacting

**Technical specifications**

**Exchangeable kit ATS MA13/16xVG/Konrad**

- Outer dimensions (W x D x H): approx. 506 x 377 x 271 mm
- Number of VG male connectors: 16

**Exchangeable kit ATS MA13/S-10/Konrad**

- Outer dimensions (W x D x H): approx. 506 x 383 x 202 mm
- Number of interface blocks: max. 10

**General technical data**

- Usable area (W x D): approx. 440 x 310 mm
- Free height above PCB: approx. 58 mm
- Pushrod length: 60 mm
- GKS installation height, bottom: 10.5 mm
- GKS installation height, top: 16.0 mm
- GKS installation height, 2-stage, bottom: 10.5 | 16.0 mm
- GKS theoretical working stroke: 3 mm (bottom), 3.5 mm (top)
- Operating temperature range: + 10 °C to + 60 °C

**Test system interface**

- ATS MA13/16xVG/Konrad:



fully loaded, with 16x 96-pole VG-male connectors with wire-wrap posts for 1,536 signals

- ATS MA13/S-10/Konrad:

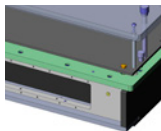

max. 10x interface blocks SB-P (DUT side) for max. 1,700 signals (not included), e.g.

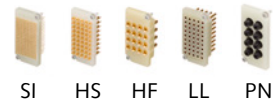

SI HS HF LL PN

**Note:**

Suitable interface blocks for the interface can be found starting on page 155.

**Note:**

INGUN provides customising documents for customisation. The replacement kits are customised according to customising guidelines info 2300.

## Ordering information

Exchangeable kits for KONRAD test systems LEON INLINE TINY		
Part no.: 54545	ATS MA13/16xVG/Konrad	Test system connection via VG multi-point connectors
Part no.: 59640	ATS MA13/S-10/Konrad	Test system connection via interface blocks

When selecting the exchangeable kit, note the test system design (VG multi-point connectors or interface blocks).

# Sealed with **EXCELLENCE.**

Contacting solutions up to 12 GHz for every industry and application:  
The **radio frequency test probes** from INGUN enable precise RF performance and resistance measurements with repeatable accuracy.

An unbeatable range of RF test probes for:

- Plug connector contacting
- Mini-switch contacting
- PCB contacting
- Dipole contacting

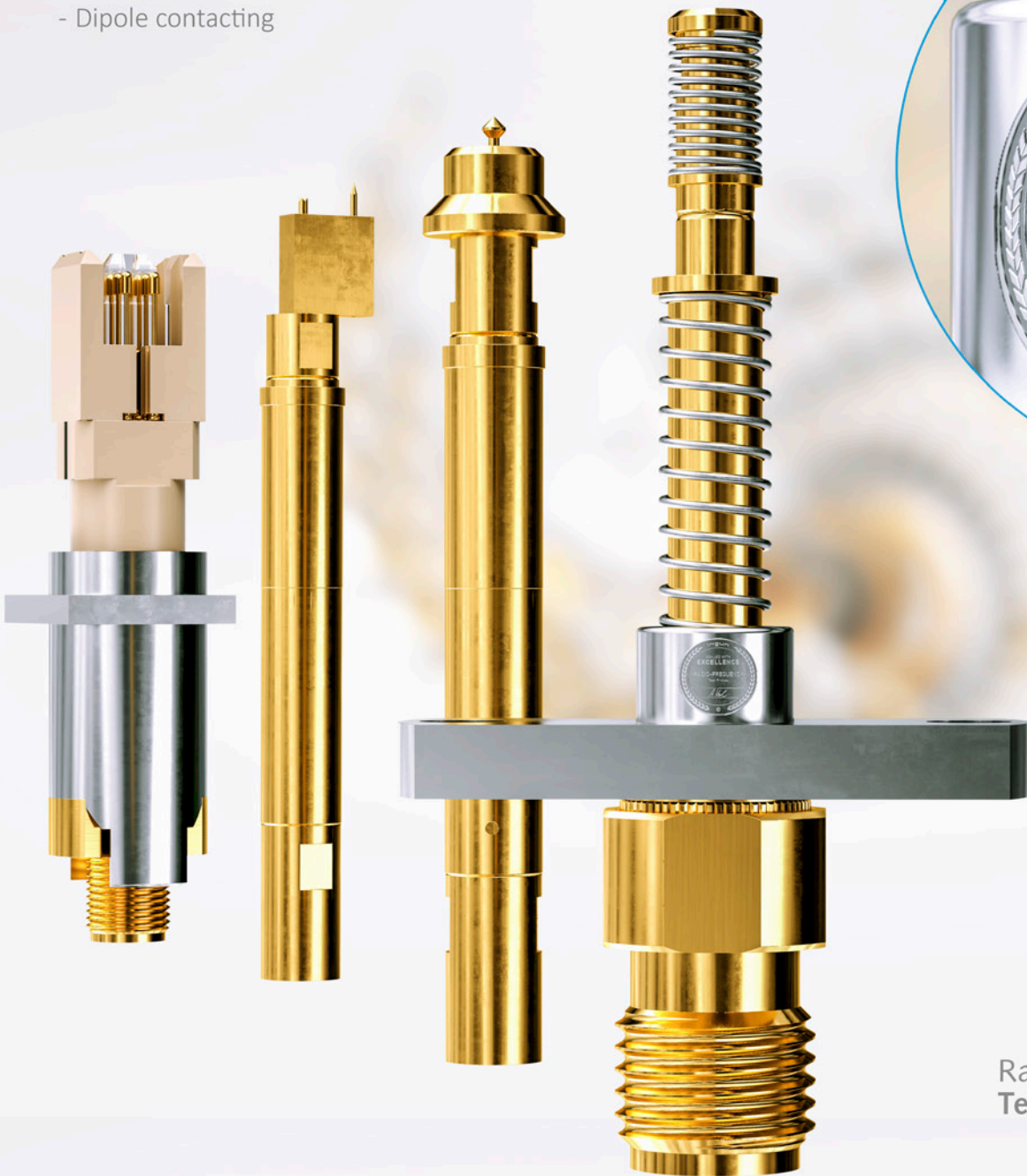

Radio Frequency  
Test Probes

Interchangeable kits WS SPEA/3030  
for high volume tests in SPEA 3030 test systems  
COMPACT, MULTIMODE or INLINE

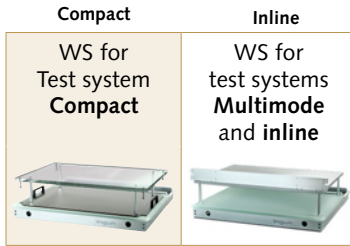

Legend:  
x = required  
(x) = ESD required  
o = not required

### Features

- Modular design
- Robust version with aluminium frame
- 10 mm thick bend-resistant probe plate made of FR4
- ESD-compliant, precision-guided DUT support
- Two-part, floating mounted test system interface
- 15 mm thick pressure frame plate
- Single-sided, single / dual-stage, or double-sided, single-stage contacting

### Technical specifications

#### Interchangeable kits

- Outer dimensions (W x D x H):
  - WSU SPEA/3030/IL-OL/FR4: approx. 620 x 560 x 66 mm
  - WSU SPEA/3030/IL-OL/FR4-ESD: approx. 620 x 560 x 66 mm
  - WSP SPEA/3030/OL: approx. 578 x 386 x 33 mm
  - WSO SPEA/3030/OL/PAS: approx. 597 x 410 x 116 mm
  - WSO SPEA/3030/IL/AL: approx. 630 x 410 x 166 mm
  - WSU SPEA/3030/IL/DH: approx. 620 x 687 x 66 mm
- Usable area (W x D): approx. 500 x 300 mm
- GKS installation height, bottom: 13.0 mm
- GKS installation height, top: 16.0 mm
- GKS installation height, 2-stage, bottom: 13.0 | 18.3 mm
- GKS theoretical working stroke: 4.0 mm (bottom), 4 mm (top)
- Operating temperature range: + 10 °C to + 60 °C

#### Test system interface

- SPEA 3030:

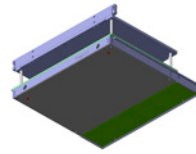

#### Single head:

max. 44 pin multipoint connectors, 2x 36-pole for max. 3,168 signals, not included

#### Dual Head:

max. 88 pin multipoint connectors, 2x 36-pole for max. 6,336 signals, not included



WSU SPEA/3030/IL-OL/FR4  
Interchangeable kit **bottom part** (version: Standard)

	x	x
--	---	---

WSU SPEA/3030/IL-OL/FR4-ESD  
Interchangeable kit **bottom part** (version: ESD)

	(x) - ESD -	(x) - ESD -
--	----------------	----------------

WSP SPEA/3030/OL  
Interchangeable kit **DUT support** (version: ESD)

	x	o
--	---	---

WSO SPEA/3030/OL/PAS  
Interchangeable kit **top part** (version: acrylic glass)

	x	o
--	---	---

WSO SPEA/3030/IL/AL  
Interchangeable kit **top part** (version: aluminium)

	o	x
--	---	---

WSU SPEA/3030/IL/DH  
Interchangeable kit **bottom part** (version: dual)

	<u>Compatible with:</u> Test systems SPEA 3030 Inline Dual Head	
--	---	--

### Further information

	WS SPEA/3030 for test systems SPEA 3030 Compact, Multimode and Inline	
Pushrod length (mm)	96.2	
Free height above PCB (mm)	60.0	Single-sided contacting
	12.0	Double-sided contacting

#### Note:

SPEA Opens Test components can be found on page 111.

## Ordering information

Interchangeable kits		
Part no.: 54990	WSU SPEA/3030/IL-OL/FR4	Interchangeable kit bottom part, KTP made of FR4
Part no.: 54270	WSU SPEA/3030/IL-OL/FR4-ESD	Interchangeable kit bottom part, ESD, KTP made of FR4 (ESD painted)
Part no.: 53730-KIT	WSP SPEA/3030/OL	Interchangeable kit DUT support, ESD, ADP made of FR4 (ESD painted)
Part no.: 52534-KIT	WSO SPEA/3030/OL/PAS	Interchangeable kit top part, NHP from acrylic glass (antistatic)
Part no.: 54984-KIT	WSO SPEA/3030/IL/AL	Interchangeable kit top part, NHP from aluminium
Part no.: 55720	WSU SPEA/3030/IL/DH	Interchangeable kit, bottom, SPEA 3030 inline Dual Head, KTP made of FR4

Parts with the ending "-KIT" are delivered unassembled. This enables immediate DUT-specific processing.

Series: Customisation accessories  
 Compatible interchangeable kits: WS for SPEA test systems

**Test system interface SPEA 3030**



	Part number	Description	Version	Compatible with
	24685	Pin strip VarPol	2x 36 pole, gold plated	Unloaded WS 3030 interface

**Stiffener bars WSP / WSO**

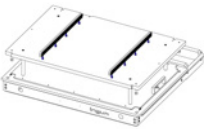
For customisation with more than 300 test probes or a force greater than 500 N, we recommend the use of stiffener bars to prevent bending of the pressure plate (ADP) or the pressure frame plate (NHP). The scope of delivery includes two multipoint connectors with fixing material.

	Part number	Description	Version	Compatible with
	52742	Stiffener bars WSP	Aluminium (3.3206)	WSP SPEA/3030/OL
	52741	Stiffener bars WSO	Structural steel (1.0037)	WSO SPEA/3030/ OL/PAS

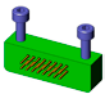
**Customisation and mounting parts**

	Part number	Description	Version	Compatible with
	53365	Strip holders	1-fold (4 pieces needed)	Interchangeable kit - Inline
	53337	Coding block	1-fold (1 pieces needed)	
	60291	Temperature measurement NTC	Incl. NTC temperature sensor and spring-loaded test probe	Interchangeable kit - Compact - Multimode - Inline



Test system	KABTEC	KEYSIGHT		KONRAD		SPEA		
	KT1001i	Medalist i3070-5i	Medalist i1000D	LEON Inline TINY		SPEA 3030 Inline		
<b>WS / ATS description</b>	ATS MA12/S-7/ Kabtec	WS Keysight/ i3070-5i	-	ATS MA13/16xVG/ Konrad	ATS MA13/S-10/ Konrad	-		
<b>WSU / KTE description</b>	-	WSU Keysight/ i3070-5i	WSU Keysight/ i1000D	-	-	WSU SPEA/3030/ IL-OL/FR4	WSU SPEA/3030/ IL-OL/ FR4-ESD Version: ESD	WSU SPEA/3030/ IL/DH  Version: Dual Head
<b>WSO / NDH description</b>	-	WSO Keysight/ i3070-5i	WSO Keysight/ i1000D	-	-	WSO SPEA/3030/IL/AL		
<b>WS / ATS part number</b>	101865 + 45903-KIT or 46236-KIT	48136-KIT	-	54545	59640	-		
<b>WSU / KTE part number</b>	-	48152	53790	-	-	54990	54270	55720
<b>WSO / NDH part number</b>	-	48151	53910	-	-	54984-KIT		
<b>WS / ATS outer dimensions (W x D x H mm)</b>	350 x 313 x 203	566 x 403 x 278	-	506 x 377 x 271	506 x 383 x 202	-		
<b>WSU / KTE outer dimensions (W x D x H mm)</b>	-	566 x 403 x 65	470 x 369 x 125	-	-	620 x 560 x 66	620 x 560 x 66	620 x 687 x 66
<b>WSO / NDH outer dimensions (W x D x H mm)</b>	-	455 x 341 x 197	459 x 340 x 167	-	-	630 x 410 x 166		
<b>Usable area (W x D mm)</b>	285 x 240	405 x 341	390 x 280	440 x 310		500 x 300		
<b>Free height above PCB</b>	53.6 mm	11 mm	58 mm	58 mm		60 mm (single-sided contacting) 12 mm (double-sided contacting)		
<b>Free height below PCB</b>	2.5 mm	2.5 mm	2.5 mm	2.5 mm		2.5 mm		
<b>Length of pushrod</b>	55.6 mm	20 mm (4 mm sunk in)	60 mm	60 mm		96.2 mm		
<b>GKS installation height, bottom</b>	16.0 mm	16.0 mm	13.0 mm	10.5 mm		13.0 mm		
<b>GKS installation height, top</b>	16.0 mm	16.0 mm	16.0 mm	16.0 mm		16.0 mm		
<b>GKS installation height, dual- stage, bottom</b>	16.0   21.5 mm	16.0   21.5 mm	13.0   18.3 mm	10.5   16.0 mm		13.0   18.3 mm		
<b>Operating temperature range</b>	+ 10°C to + 60°C	+ 10°C to + 60°C	+ 10°C to + 60°C	+ 10°C to + 60°C		+ 10°C to + 60°C		
<b>Test system interface</b>	Max. 7 Interface blocks SB-P	Max. 3,666 personality pins	Max. 42x 64-pole VG female socket connectors	Incl. 16x 96- pole VG male multipoint connectors	Max. 10 Interface blocks SB-P (DUT side)	Max. 44 Pin multipoint connectors 2x 36-pole		Max. 88 Pin multipoint connectors 2x 36-pole



# Customising Accessories

- Interface blocks
- Marking units
- Side approach mechanisms
- Button actuator
- Screw units
- etc.

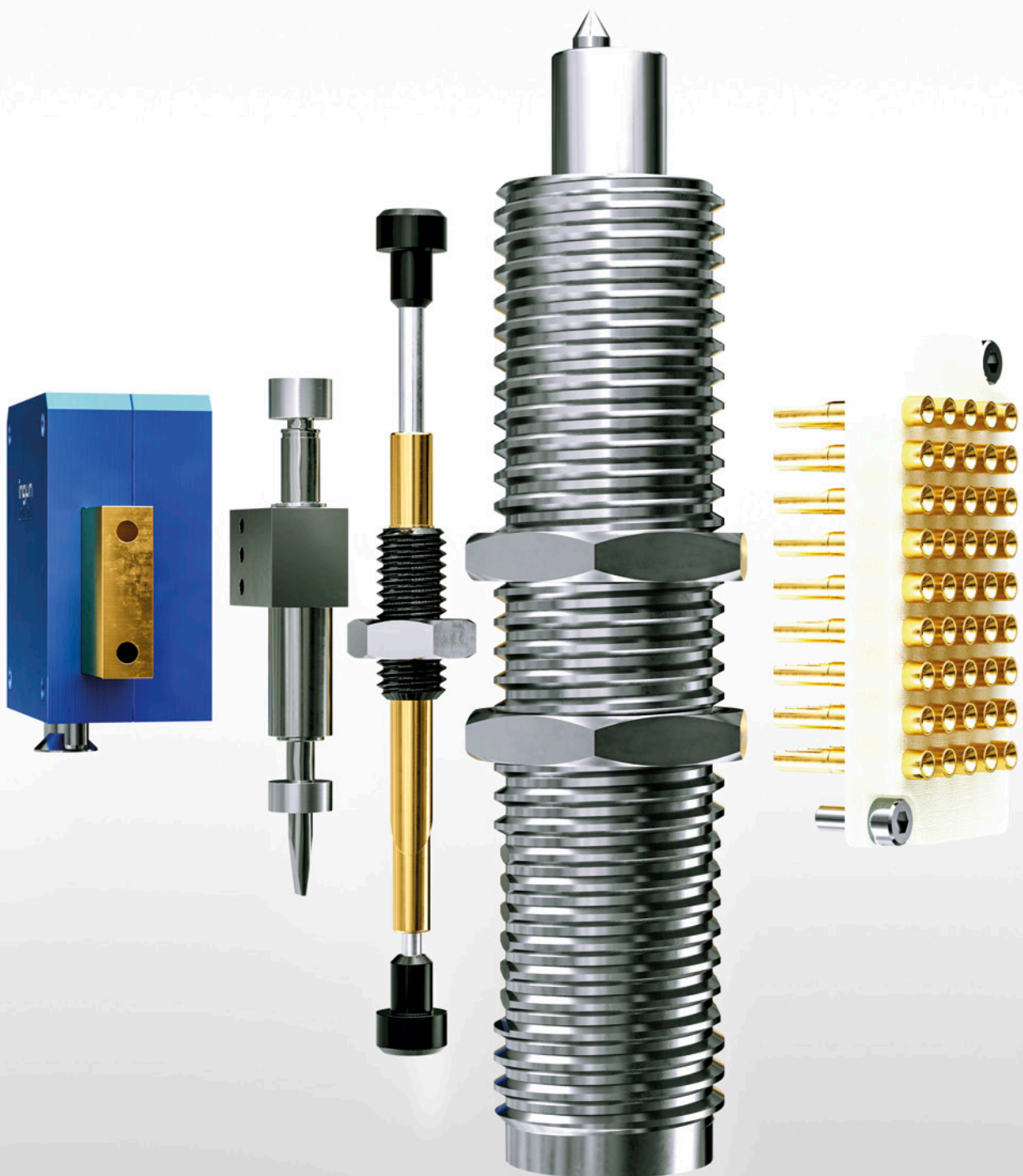

# Customising accessories

## The right solution for any testing requirement

For customisation specific to the DUT, various customising parts are used depending on the actual testing requirement, characteristics and component assembly of the electronic unit. Find out more about our high-quality customising parts, which are available for any testing requirement. Parts required include the following:

### Standard customising parts

- PCB support pins (PAS)
- Tooling pins (FS/GFS)
- Pre-centring pins (VZ)
- Pushrods (NHS)
- Spring-loaded test probes (GKS)
- Receptacles (KS)

### DUT-specific customising parts

- Marking units (ME)
- Side approach mechanisms (SAM)
- Connectors (STK)
- Test plugs (PS)
- Screwing units (SBE)
- Button activators (TAB)
- LED analysers
- Fibre optic cables (LWL)
- Compressed air hoses (PUN)

### Customising parts for signal connection

- Interface blocks (SB)
- Multipoint connectors (VG)
- Transfer fields (TF)

### Additional customising parts

- Gas pressure springs (GDF)
- Guide bushes (FUB)
- Guide pins (FUS)
- Springs (FED)
- ESD kits
- Stroke-limiting disks (HBS)
- Stroke sensors (HMK)
- Stroke counters (HZ)
- Snap-on fasteners

### Test system-specific customising parts

- Test probes for interfaces
- Contact terminals (KT)

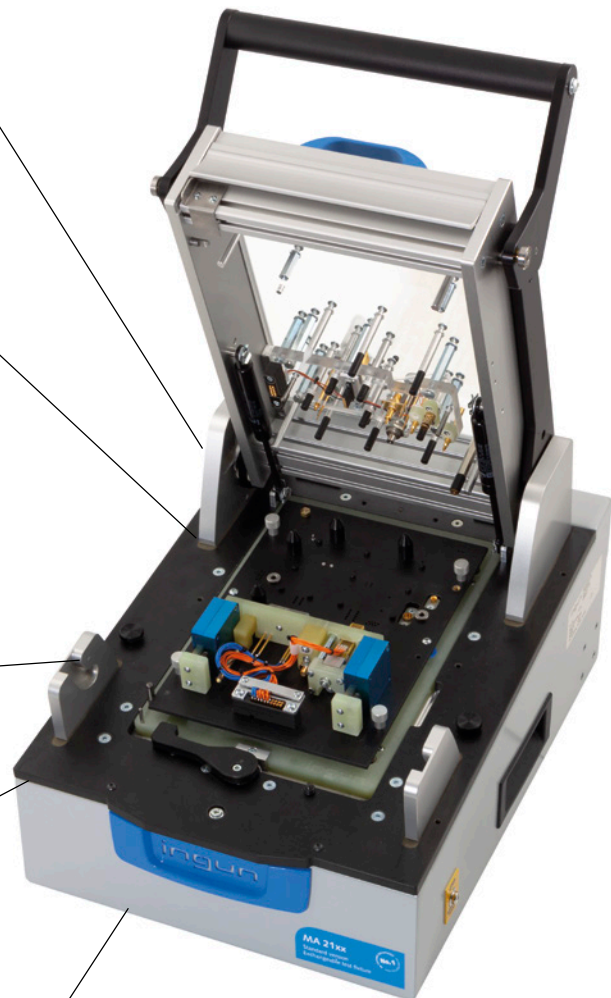

**A made-to-measure modular system**

With our extensive range of various customising accessory parts, we offer a wide variety of suitable assemblies, functional units and component parts for the standard and project-specific customisation of your test fixture or exchangeable/interchangeable kit.

Several different types of **customising accessories** are available, such as:

<p><b>Start-up kits (SK)</b></p>  <p>For self-customisation of test fixtures or exchangeable/interchangeable kits with popular customisation parts.</p>	<p><b>Interface blocks (SB)</b></p>  <p>A conducting connector in internal, external or customer-specific interfaces.</p>	<p><b>Marking units (ME)</b></p>  <p>For marking "good" tested DUTs with a permanent mark.</p>
<p><b>Side approach mechanisms (SAM)</b></p>  <p>For lateral contacting of electronic components on DUTs to be tested.</p>	<p><b>Connectors (STK)</b></p>  <p>For low-wear contacting of plug connectors on DUTs to be tested.</p>	<p><b>Test plugs (PS)</b></p>  <p>For low-wear contacting of plug connectors on DUTs to be tested.</p>
<p><b>Screwing units (SBE)</b></p>  <p>For space-saving alignment of adjustable screw-in devices during testing.</p>	<p><b>Button activators (TAB)</b></p>  <p>For the space-saving activation of buttons and spring-loaded switches during testing.</p>	<p><b>Pushrods (NHS)</b></p>  <p>To fix PC boards securely against the force of the test probe during contacting.</p>
<p><b>Transfer fields (TF)</b></p>  <p>For the transfer of signals from top and/or side contactings with spring-loaded test probes.</p>	<p><b>PCB support pins (PAS)</b></p>  <p>To support PC boards to be tested.</p>	<p><b>Tooling pins (FS/GFS)</b></p>  <p>For holding and securely fixing PC boards via the tooling holes.</p>

..and many more.

**Customising accessories**

Start-up kits (SK)	154
Interface blocks (SB)	155
Marking units (ME)	171
Side approach mechanisms (SAM)	179
Connectors (STK)	186
Test plugs (PS)	188
Screwing units (SBE)	190
Button activators (TAB)	193
Pushrods (NHS)	194
Transfer fields (TF)	196
PCB support pins (PAS)	197
Tooling pins (FS/GFS)	198
Pre-centring pins (VZ)	202
Springs (FED)	203
Gas pressure springs (GDF)	204
Multipoint connectors (VG)	205
Cleaning mats (KRM)	206
Guide bushes (FUB)	207
Guide pins (FUS)	207
Stroke-limiting disks (HBS)	207
ESD kits	207
Stroke sensors (HMK)	208
Snap-on fasteners	208
Stroke counters (HZ)	208
Feasa LED analysers	209
Fibre optic cables (LWL)	209
Compressed air hoses (PUN)	209
Test probes for interfaces	210
Contact terminals (KT)	211

Series: SK

Version: Customisation I mounting

Customisation dimension:  $\leq 20 \text{ mm}$  |  $\leq 60 \text{ mm}$

## Start-up kits (SK)

### Start-up kits for customisation, incl. KS and GKS



#### SK-A-20-10,5

– For exchangeable kits with customisation dimensions  $\leq 20 \text{ mm}$  (e.g. ATS MA160)



#### SK-A-60-10,5-Small (...-Medium | ...-Large)

– For exchangeable kits with customisation dimensions  $\leq 60 \text{ mm}$  (e.g. ATS MA260/350/360, ATS MAxx)

### Start-up kits for mounting without KS and GKS

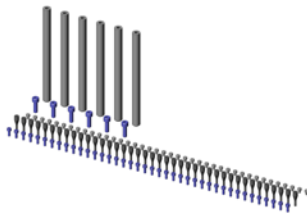

#### SK-M-20-WS

– For Keysight interchangeable kits WS Keysight/i3070-5i

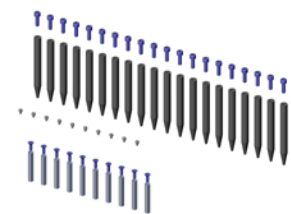

#### SK-M-96-WS

– For SPEA interchangeable kits WS SPEA/3030/Inline

## Usage

For customisation of the exchangeable kits on site, various start-up kits (SK) are provided with popular customisation parts required for customisation.

## Delivery includes

Start-up kits (SK) for customisation:

SK-A-20-10,5 (incl. screws)	
Quantity [unit]	Designation
10	NHS-ST-20-2,5-POM-M3 (pushrod)
10	PAS-02,8-05,0 (PCB support pin)
2	FS-2,90-RD-07-02 (tooling pin)
2	FS-4,00-RD-07-02 (tooling pin)
4	VZ-R-10-12,5-K (pre-centring pin)
50	KS-100 30 05 (receptacle – solder cup)
25	GKS-100 291 090 A 2000 (test probe – dagger)
25	GKS-100 214 150 A 2000 (test probe – crown)

SK-A-60-10,5-Small	SK-A-60-10,5-Medium	SK-A-60-10,5-Large	(incl. screws)
Quantity [unit]			Designation
5	10	15	NHS-ST-60-6-PA-AL (pushrod)
10	20	30	NHS-ST-60-2,5-POM-AL (pushrod)
15	30	45	PAS-02,8-05,0 (PCB support pin)
2	2	2	FS-4,00-RD-07-02 (tooling pin)
3	3	3	VZ-R-12-22-K (pre-centring pin)
100	200	300	KS-100 47 05 (receptacle – wire wrap)
100	200	300	GKS-100 291 130 A 2000 (test probe – dagger)

Start-up kits (SK) for mounting:

SK-M-20-WS (incl. screws)	
Quantity [unit]	Designation
6	Spacer $\varnothing 10.0 \times 133 \text{ mm}$
40	PAS-02,8-05,0 (PCB support pin)
40	NHS-ST-20-2,5-POM-M3 (pushrod)

SK-M-96-WS (incl. screws)	
Quantity [unit]	Designation
10	Hexagon bolt M4/M4 $\times 45$ (nickel-plated brass)
10	PAS-02,8-05,0 (PCB support pin)
20	NHS-ST-96,2-3,0-PA-M5 (pushrod)

## Customisation example

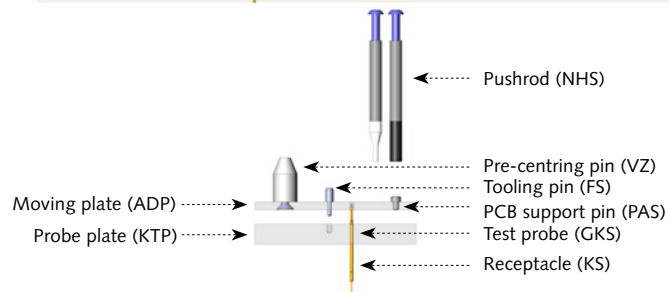

Start-up kits (SK) for customisation		
Part no.: 29070	SK-A-20-10,5	For exchangeable kits with customisation dimensions $\leq 20 \text{ mm}$
Part no.: 34730	SK-A-60-10,5-Small	For exchangeable kits with customisation dimensions $\leq 60 \text{ mm}$ , small version
Part no.: 34731	SK-A-60-10,5-Medium	For exchangeable kits with customisation dimensions $\leq 60 \text{ mm}$ , medium version
Part no.: 34732	SK-A-60-10,5-Large	For exchangeable kits with customisation dimensions $\leq 60 \text{ mm}$ , large version

Start-up kits (SK) for mounting		
Part no.: 50589	SK-M-20-WS	For Keysight interchangeable kits WS Keysight/i3070-5i
Part no.: 52745	SK-M-96-WS	For SPEA interchangeable kits WS SPEA/3030/Inline



# Interface blocks

## Reliable in-process signal transmission



### Usage

Interface blocks (SB) are used to transmit signals reliably between the test device and test system in internal, external, and customer-specific interfaces. **Signal, high current, radio frequency, fibre optic, pneumatic, mixed, HSD and special blocks** are available in various different versions.

### Signal transmission

Signal transmission occurs between two interface blocks mounted opposite each other which are designed for a working distance of  $15.1 \pm 0.5$  mm between their mounting surfaces. In each case, one interface block is loaded with spring-loaded test probes while the other has rigid contact terminals or pneumatic/fibre optic cable couplings. This achieves a continually high level of contact quality and reliable signal transmission while ensuring a uniformly low level of contact resistance. The interface blocks have uniform outer dimensions.

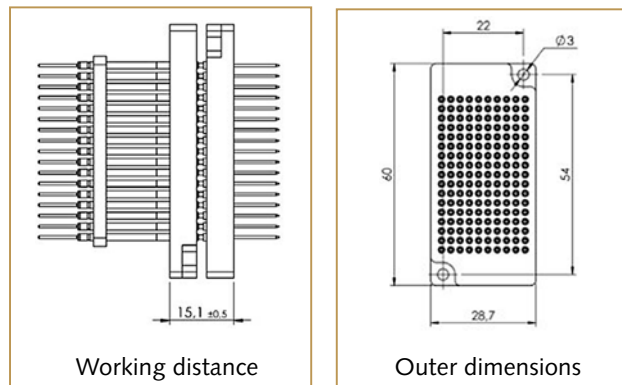

### Features

- Compact, robust design
- Reliable signal transmission
- High contact/transmission quality
- Uniformly low level of contact resistance
- Connection of internal, external and customer-specific interfaces
- Quick, simple and precise mounting

### Life span

- SB-T/P-SI-...: 300,000 load cycles (laboratory conditions)
  - SB-T/P-HS-...: 80,000 load cycles (laboratory conditions)
- The life span is determined in the laboratory with fully automatic, computer-controlled endurance test stations under full load. Since the life span depends on many different factors and in particular on the individual test application, INGUN cannot guarantee the actual duration of use in the test field.

### Interface blocks (SB)

Signal blocks (SB-T/P-SI-...)	156
High current blocks (SB-T/P-HS-...)	158
Radio frequency blocks (SB-T/P-HF-...)	160
Fibre optic blocks (SB-T/P-LL-...)	164
Pneumatic blocks (SB-T/P-PN-...)	165
Mixed blocks (SB-T/P-MB-...)	166
HSD blocks (SB-B-HSD-...)	167
Special blocks (SB-P-SO-...)	168

### Accessories

Cable connections	169
Dummy panels	169















Series: SB

Design: Signal blocks SB-T/P-SI-...

Number of poles: 170 | 136 | 85 | 40

Maximum rated current: 4 A

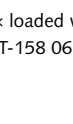
Signal blocks SB-T/P-SI-...	
Signal blocks for test system side (SB-T-SI-...)	Signal blocks for DUT side (SB-P-SI-...)
<b>170-pole signal blocks for up to 4 A</b>	
<b>SB-T-SI-170-4A-...</b>	<b>SB-P-SI-170-4A-...</b>
 <p>– Wire wrap posts</p> <p>170× loaded with: – KS-945 47 – GKS-945 357 106 A 1100</p>	 <p>– Wire wrap posts</p> <p>170× loaded with: – KT-158 06</p>
 <p>– Low-impedance – Wire wrap posts</p> <p>170× loaded with: – KS-112 47 – HSS-118 317 175 A 1102</p>	 <p>– Round posts</p> <p>170× loaded with: – KT-158 06 44</p>
 <p>– Round posts</p> <p>170× loaded with: – KS-945 44 063 – GKS-945 357 106 A 1100</p>	 <p>– Round posts</p> <p>170× loaded with: – KT-158 06 44</p>
<b>136-pole signal blocks for up to 4 A</b>	
<b>SB-T-SI-136-4A-...</b>	<b>SB-P-SI-136-4A-...</b>
 <p>– Wire wrap posts</p> <p>136× loaded with: – KS-945 47 – GKS-945 357 106 A 1100</p>	 <p>– Wire wrap posts</p> <p>136× loaded with: – KT-158 06</p>
<b>85-pole signal blocks for up to 4 A</b>	
<b>SB-T-SI-085-4A-...</b>	<b>SB-P-SI-085-4A-...</b>
 <p>– Wire wrap posts</p> <p>85× loaded with: – KS-945 47 – GKS-945 357 106 A 1100</p>	 <p>– Wire wrap posts</p> <p>85× loaded with: – KT-158 06</p>
<b>40-pole signal blocks for up to 4 A</b>	
<b>SB-T-SI-040-4A-...</b>	<b>SB-P-SI-040-4A-...</b>
 <p>– Wire wrap posts</p> <p>40× loaded with: – KS-945 47 – GKS-945 357 106 A 1100</p>	 <p>– Wire wrap posts</p> <p>40× loaded with: – KT-158 06</p>
 <p>– Low-impedance – Wire wrap posts</p> <p>40× loaded with: – KS-112 47 – HSS-118 317 175 A 1102</p>	 <p>– Wire wrap posts</p> <p>40× loaded with: – KT-158 06</p>

## Usage

Signal blocks (SB-T/P-SI-...) can be used for the reliable transmission of low-voltage signals and dangerous voltages within the scope of their specification.

Standard and low-impedance signal blocks are offered, both without and with centring (SB-...-Z). The contact resistances ( $R_i$  typical) of the standard signal blocks are 20 mΩ and those of the low-impedance signal blocks are ≤ 10 mΩ per test probe.

Blocks are delivered fully loaded and mounting materials are included.

## General technical specifications

### Standard signal blocks for up to 4 A

- Working distance: 15.1 ± 0.5 mm
- Working stroke: 2.6 mm
- $R_i$  typical one test probe: 20 mΩ
- Centring range (only for SB-...-Z): ± 0.3 mm
- Operating temperature range: - 30 °C to + 80 °C
- RoHS (2011/65/EC): compliant

### Low-impedance signal blocks for up to 4 A

- Working distance: 15.1 ± 0.5 mm
- Working stroke: 4.0 mm
- $R_i$  typical one test probe: ≤ 10 mΩ
- Centring range (only for SB-...-Z): ± 0.3 mm
- Operating temperature range: - 30 °C to + 80 °C
- RoHS (2011/65/EC): compliant

## Customisation example

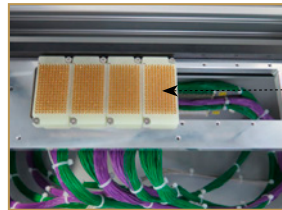

Internal interface on MA 2112/D/H/S-7 loaded with interface blocks (SB-T-...)

Interface blocks SB-T-SI-170-4A (part 27616)

## Ordering information

Signal blocks for test system side SB-T-SI-...													
Part no.	Designation	Version	Number of loaded components	Connection	Spring force	R <sub>i</sub> typical, one test probe	Max. rated current, one test probe	Max. rated current, all test probes	Shortest distance between GKS / KS (unwired)	Max. permitted voltage	Minimum cable cross-section	Maximum power loss	No. of SB-P-SI-...
27616	SB-T-SI-170-4A	Standard	170x	Wire wrap Posts	187 N	20 mΩ	4 A	1 A (170 A)	0.64 mm	510 V	0.25 mm <sup>2</sup>	4 W	1
38690	SB-T-SI-170-4A-Z	Standard (incl. centring pins)	170x	Wire wrap Posts	187 N	20 mΩ	4 A	1 A (170 A)	0.64 mm	510 V	0.25 mm <sup>2</sup>	4 W	2
31006	SB-T-SI-170-4A-N	Low-impedance	170x	Wire wrap Posts	187 N	≤ 10 mΩ	4 A	1.5 A (255 A)	0.34 mm	270 V	0.25 mm <sup>2</sup>	5 W	1
38694	SB-T-SI-170-4A-N-Z	Low-impedance (incl. centring pins)	170x	Wire wrap Posts	187 N	≤ 10 mΩ	4 A	1.5 A (255 A)	0.34 mm	270 V	0.25 mm <sup>2</sup>	5 W	2
51690	SB-T-SI-170-4A-RD	Standard	170x	Round Posts	187 N	20 mΩ	4 A	1 A (170 A)	0.64 mm	510 V	0.25 mm <sup>2</sup>	4 W	3
36800	SB-T-SI-136-4A	Standard	136x	Wire wrap Posts	150 N	20 mΩ	4 A	1 A (136 A)	0.64 mm	510 V	0.25 mm <sup>2</sup>	4 W	4
30181	SB-T-SI-085-4A	Standard	85x	Wire wrap Posts	93.5 N	20 mΩ	4 A	2 A (170 A)	1.69 mm	1,350 V	0.25 mm <sup>2</sup>	7 W	5
42346	SB-T-SI-085-4A-Z	Standard (incl. centring pins)	85x	Wire wrap Posts	93.5 N	20 mΩ	4 A	2 A (170 A)	1.69 mm	1,350 V	0.25 mm <sup>2</sup>	7 W	6
37075	SB-T-SI-040-4A	Standard	40x	Wire wrap Posts	44 N	20 mΩ	4 A	3 A (120 A)	3.18 mm	2,540 V	0.25 mm <sup>2</sup>	7.5 W	7
42342	SB-T-SI-040-4A-Z	Standard (incl. centring pins)	40x	Wire wrap Posts	44 N	20 mΩ	4 A	3 A (120 A)	3.18 mm	2,540 V	0.25 mm <sup>2</sup>	7.5 W	8
44225	SB-T-SI-040-4A-N	Low-impedance	40x	Wire wrap Posts	44 N	≤ 10 mΩ	4 A	3 A (120 A)	2.88 mm	2,300 V	0.25 mm <sup>2</sup>	7.5 W	7
44226	SB-T-SI-040-4A-N-Z	Low-impedance (incl. centring pins)	40x	Wire wrap Posts	44 N	≤ 10 mΩ	4 A	3 A (120 A)	2.88 mm	2,300 V	0.25 mm <sup>2</sup>	7.5 W	8

Signal blocks for DUT side SB-P-SI-...													
Part no.	Designation	Version	Number of loaded components	Connection	Spring force	R <sub>i</sub> typical, one test probe	Max. rated current, one test probe	Max. rated current, all test probes	Shortest distance between KTs (unwired)	Max. permitted voltage	Minimum cable cross-section	Maximum power loss	No.
13515	SB-P-SI-170-4A-0,6	Standard	170x	Wire wrap Posts	-	≤ 5 mΩ	4 A	1 A (170 A)	0.64 mm	510 V	0.25 mm <sup>2</sup>	4 W	1
38692	SB-P-SI-170-4A-0,6-Z	Standard (incl. centring bushes)	170x	Wire wrap Posts	-	≤ 5 mΩ	4 A	1 A (170 A)	0.64 mm	510 V	0.25 mm <sup>2</sup>	4 W	2
52313	SB-P-SI-170-4A-0,6-RD	Standard	170x	Round Posts	-	≤ 5 mΩ	4 A	1 A (170 A)	0.64 mm	510 V	0.25 mm <sup>2</sup>	4 W	3
33665	SB-P-SI-136-4A-0,6	Standard	136x	Wire wrap Posts	-	≤ 5 mΩ	4 A	1 A (136 A)	0.64 mm	510 V	0.25 mm <sup>2</sup>	4 W	4
44271	SB-P-SI-085-4A-0,6	Standard	85x	Wire wrap Posts	-	≤ 5 mΩ	4 A	2 A (170 A)	1.69 mm	1,350 V	0.25 mm <sup>2</sup>	7 W	5
42344	SB-P-SI-085-4A-0,6-Z	Standard (incl. centring bushes)	85x	Wire wrap Posts	-	≤ 5 mΩ	4 A	2 A (170 A)	1.69 mm	1,350 V	0.25 mm <sup>2</sup>	7 W	6
37074	SB-P-SI-040-4A-0,6	Standard	40x	Wire wrap Posts	-	≤ 5 mΩ	4 A	3 A (120 A)	3.18 mm	2,540 V	0.25 mm <sup>2</sup>	7.5 W	7
42339	SB-P-SI-040-4A-0,6-Z	Standard (incl. centring bushes)	40x	Wire wrap Posts	-	≤ 5 mΩ	4 A	3 A (120 A)	3.18 mm	2,540 V	0.25 mm <sup>2</sup>	7.5 W	8

Series: SB

Design: High current blocks SB-T/P-HS-...

Number of poles: 45 | 34 | 24 | 8 | 4 | 2

Maximum rated current: 50 A

High current blocks SB-T/P-HS-...	
High current blocks for test system side (SB-T-HS-...)	High current blocks for DUT side (SB-P-HS-...)
45-pole high current blocks for up to 30 A	
<b>SB-T-HS-045-30A-...</b>	<b>SB-P-HS-045-30A-...</b>
<p>– Solder cup</p> <p>45× loaded with: – KS-113 30 M2-R – HSS-120 317 300 A 1502 M</p>	<p>– Solder cup</p> <p>45× loaded with: – KT-120 L3 E02-30</p>
34-pole high current blocks for up to 20 A	
<b>SB-T-HS-034-20A-...</b>	<b>SB-P-HS-034-20A-...</b>
<p>– Solder cup</p> <p>34× loaded with: – KS-112 30 M-R – HSS-118 317 175 A 1502 M</p>	<p>– Solder cup</p> <p>34× loaded with: – KT-254 L3 E02-30</p>
24-pole high current blocks for up to 30 A	
<b>SB-T-HS-024-30A-...</b>	<b>SB-P-HS-024-30A-...</b>
<p>– Solder cup</p> <p>24× loaded with: – KS-113 30 M2-R – HSS-120 317 300 A 2202 M</p>	<p>– Solder cup</p> <p>24× loaded with: – KT-120 L3 E02-30</p>
8-pole high current blocks for up to 50 A	
<b>SB-T-HS-008-50A-...</b>	<b>SB-P-HS-008-50A-...</b>
<p>– M3 threaded posts</p> <p>8× loaded with: – KS-150 M3 M3-R – HSS-150 317 300 A 5002 M</p>	<p>– M3 threaded posts</p> <p>8× loaded with: – KT-150 L3 E03-M3</p>
4-pole high current blocks for up to 50 A	
<b>SB-T-HS-004-50A-...</b>	<b>SB-P-HS-004-50A-...</b>
<p>– M3 threaded posts</p> <p>4× loaded with: – KS-150 M3 M3-R – HSS-150 317 300 A 5002 M</p>	<p>– M3 threaded posts</p> <p>4× loaded with: – KT-150 L3 E03-M3</p>
2-pole high current blocks for up to 50 A	
<b>SB-T-HS-002-50A-...</b>	<b>SB-P-HS-002-50A-...</b>
<p>– M3 threaded posts</p> <p>2× loaded with: – KS-150 M3 M3-R – HSS-150 317 300 A 5002 M</p>	<p>– M3 threaded posts</p> <p>2× loaded with: – KT-150 L3 E03-M3</p>

## Usage

High current blocks (SB-T/P-HS-...) can be used for the reliable transmission of high currents and dangerous voltages within the scope of their specification.

High current blocks without and with centring (SB-...-Z) are offered. The contact resistances ( $R_j$  typical) are  $\leq 10 \text{ m}\Omega$  per test probe.

Blocks are delivered fully loaded and mounting materials are included.

## General technical specifications

### High current blocks for up to 20 A / 30 A

- Working distance:  $15.1 \pm 0.5 \text{ mm}$
- Working stroke:  $4.0 \text{ mm}$
- $R_j$  typical one test probe:  $\leq 10 \text{ m}\Omega$
- Centring range (only for SB-...-Z):  $\pm 0.3 \text{ mm}$
- Operating temperature range:  $-30 \text{ }^\circ\text{C}$  to  $+120 \text{ }^\circ\text{C}$
- RoHS (2011/65/EC): compliant

### High current blocks for up to 50 A

- Working distance:  $15.1 \pm 0.5 \text{ mm}$
- Working stroke:  $4.4 \text{ mm}$
- $R_j$  typical one test probe:  $\leq 10 \text{ m}\Omega$
- Centring range (only for SB-...-Z): –
- Operating temperature range:  $-30 \text{ }^\circ\text{C}$  to  $+120 \text{ }^\circ\text{C}$
- RoHS (2011/65/EC): compliant

## Customisation example

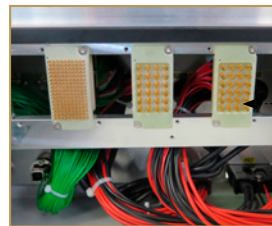

Interface blocks  
SB-T-HS-024-30A (part 27628)

Internal interface on  
MA 2112/D/H/S-7 loaded with  
interface blocks (SB-T-...)

## Ordering information

High current blocks for test system side SB-T-HS-...													
Part no.	Designation	Version	Number of loaded components	Connection	Spring force	Ri typical, one test probe	Max. rated current one test probe	Max. rated current all test probes	Shortest distance between HSS / KT's (unwired)	Max. permitted voltage	Minimum cable cross-section	Maximum power loss	No. of SB-P-HS-...
30963	SB-T-HS-045-30A	Standard	45x	Solder cup	67.5 N	≤ 10 mΩ	30 A	10 A (450 A)	1.48 mm	1.180 V	1.5 mm <sup>2</sup>	25 W	1
38697	SB-T-HS-045-30A-Z	Standard (incl. centring pins)	45x	Solder cup	67.5 N	≤ 10 mΩ	30 A	10 A (450 A)	1.48 mm	1.180 V	1.5 mm <sup>2</sup>	25 W	2
31011	SB-T-HS-034-20A	Standard	34x	Solder cup	51 N	≤ 10 mΩ	20 A	1.5 A (51 A)	3.0 mm	270 V	0.25 mm <sup>2</sup>	5 W	3
27628	SB-T-HS-024-30A	Standard	24x	Solder cup	52.8 N	≤ 10 mΩ	30 A	16 A (384 A)	2.4 mm	1.920 V	1.5 mm <sup>2</sup>	25 W	4
38699	SB-T-HS-024-30A-Z	Standard (incl. centring pins)	24x	Solder cup	52.8 N	≤ 10 mΩ	30 A	16 A (384 A)	2.4 mm	1.920 V	1.5 mm <sup>2</sup>	25 W	5
35549	SB-T-HS-008-50A	Standard	8x	M3 Threaded posts	40 N	≤ 10 mΩ	50 A	35 A (280 A)	7.0 mm	6.000 V	6.0 mm <sup>2</sup>	25 W	6
37699	SB-T-HS-004-50A	Standard	4x	M3 Threaded posts	20 N	≤ 10 mΩ	50 A	35 A (140 A)	9.1 mm	6.000 V	6.0 mm <sup>2</sup>	25 W	7
31549	SB-T-HS-002-50A	Standard	2x	M3 Threaded posts	10 N	≤ 10 mΩ	50 A	35 A (70 A)	15.7 mm	6.000 V	6.0 mm <sup>2</sup>	25 W	8

High current blocks for DUT side SB-P-HS-...													
Part no.	Designation	Version	Number of loaded components	Connection	Spring force	Ri typical, one test probe	Max. rated current one test probe	Max. rated current all test probes	Shortest distance between KT's (unwired)	Max. permitted voltage	Minimum cable cross-section	Maximum power loss	No.
16900	SB-P-HS-045-30A-1,0	Standard	45x	Solder cup	-	≤ 5 mΩ	30 A	10 A (450 A)	1.48 mm	1,180 V	1.5 mm <sup>2</sup>	25 W	1
38698	SB-P-HS-045-30A-1,0-Z	Standard (incl. centring bushes)	45x	Solder cup	-	≤ 5 mΩ	30 A	10 A (450 A)	1.48 mm	1,180 V	1.5 mm <sup>2</sup>	25 W	2
31009	SB-P-HS-034-20A-1,0	Standard	34x	Solder cup	-	≤ 5 mΩ	20 A	1.5 A (51 A)	3.0 mm	270 V	0.25 mm <sup>2</sup>	5 W	3
27620	SB-P-HS-024-30A-1,0	Standard	24x	Solder cup	-	≤ 5 mΩ	30 A	16 A (384 A)	2.4 mm	1,920 V	1.5 mm <sup>2</sup>	25 W	4
38700	SB-P-HS-024-30A-1,0-Z	Standard (incl. centring bushes)	24x	Solder cup	-	≤ 5 mΩ	30 A	16 A (384 A)	2.4 mm	1,920 V	1.5 mm <sup>2</sup>	25 W	5
35929	SB-P-HS-008-50A-1,0	Standard	8x	M3 Threaded posts	-	≤ 5 mΩ	50 A	35 A (280 A)	7.0 mm	6,000 V	6.0 mm <sup>2</sup>	25 W	6
37698	SB-P-HS-004-50A-1,0	Standard	4x	M3 Threaded posts	-	≤ 5 mΩ	50 A	35 A (140 A)	9.1 mm	6,000 V	6.0 mm <sup>2</sup>	25 W	7
31550	SB-P-HS-002-50A-1,0	Standard	2x	M3 Threaded posts	-	≤ 5 mΩ	50 A	35 A (70 A)	15.7 mm	6,000 V	6.0 mm <sup>2</sup>	25 W	8

**Note:**



For the high current blocks SB-T/P-HS-008-50A, SB-T/P-HS-004-50A and SB-T/P-HS-002-50A, cable clips (part 35925) and lock nuts (part KM-650 30 S) can be ordered separately.

Series: SB

Design: Radio frequency blocks SB-T/P-HF-...

Number of poles: 1 to 16

Frequency range: 0.7 GHz

Radio frequency blocks SB-T/P-HF-... up to 0.7 GHz	
Radio frequency blocks for test system side (SB-T-HF-...)	Radio frequency blocks for DUT side (SB-P-HF-...)
1 to 16-pole radio frequency blocks for up to 0.7 GHz	
SB-T-HF-016-0,7GHz-xx	SB-P-HF-016-0,7GHz-xx
 – Plug SE-...	 – Plug SE-...
Max. 16x loaded with: – KS-110 23 – HFS-110 307 100 A 3002 A	Max. 16x loaded with: – SB-810 Z

## Usage

These radio frequency blocks (SB-T/P-HF-...) can be used for the reliable transmission of signals up to 0.7 GHz.

The radio frequency blocks are designed to mount up to 16 transfer contact terminals and can be ordered loaded with between 1 and 16 RF probes (HFS) / contact terminals (KT), according to test requirements. The loading positions for partially loaded radio frequency blocks can be selected as required. Radio frequency blocks up to 0.7 GHz are offered without centring.

Delivery includes mounting materials.

## Technical specifications

### Radio frequency blocks for up to 0.7 GHz

– Working distance:	15.1 ± 0.5 mm
– Working stroke:	4.0 mm
– Spring force:	up to 48 N
– Frequency range:	up to 0.7 GHz
– Impedance:	50 Ω
– Centring range (only for SB-...-Z):	–
– Operating temperature range:	- 30 °C to + 80 °C
– Connection:	plug SE-...
– RoHS (2011/65/EC):	compliant

### Note:

SE-... plugs with pre-wired RF coaxial cables are not included in the scope of delivery and can be ordered separately (see RF test probe catalogue).



## Ordering information

### Radio frequency blocks SB-T/P-HF-... up to 0.7 GHz

Radio frequency blocks for test system side SB-T-HF-...		
Part no.	Designation	No. of HFS
38125	SB-T-HF-016-0,7GHz-01	1
38124	SB-T-HF-016-0,7GHz-02	2
38123	SB-T-HF-016-0,7GHz-03	3
38122	SB-T-HF-016-0,7GHz-04	4
38121	SB-T-HF-016-0,7GHz-05	5
38120	SB-T-HF-016-0,7GHz-06	6
38119	SB-T-HF-016-0,7GHz-07	7
38118	SB-T-HF-016-0,7GHz-08	8
38117	SB-T-HF-016-0,7GHz-09	9
38116	SB-T-HF-016-0,7GHz-10	10
38115	SB-T-HF-016-0,7GHz-11	11
38114	SB-T-HF-016-0,7GHz-12	12
38113	SB-T-HF-016-0,7GHz-13	13
38112	SB-T-HF-016-0,7GHz-14	14
38111	SB-T-HF-016-0,7GHz-15	15
31004	SB-T-HF-016-0,7GHz	16

Radio frequency blocks for DUT side SB-P-HF-...		
Part no.	Designation	No. of KT
38170	SB-P-HF-016-0,7GHz-01	1
38169	SB-P-HF-016-0,7GHz-02	2
38168	SB-P-HF-016-0,7GHz-03	3
38167	SB-P-HF-016-0,7GHz-04	4
38166	SB-P-HF-016-0,7GHz-05	5
38165	SB-P-HF-016-0,7GHz-06	6
38164	SB-P-HF-016-0,7GHz-07	7
38163	SB-P-HF-016-0,7GHz-08	8
38162	SB-P-HF-016-0,7GHz-09	9
38161	SB-P-HF-016-0,7GHz-10	10
38160	SB-P-HF-016-0,7GHz-11	11
38159	SB-P-HF-016-0,7GHz-12	12
38158	SB-P-HF-016-0,7GHz-13	13
38157	SB-P-HF-016-0,7GHz-14	14
38156	SB-P-HF-016-0,7GHz-15	15
31002	SB-P-HF-016-0,7GHz	16



Radio frequency blocks SB-T/P-HF-... up to 2 GHz	
Radio frequency blocks for test system side (SB-T-HF-...)	Radio frequency blocks for DUT side (SB-P-HF-...)
1 to 16-pole radio frequency blocks for up to 2 GHz	
SB-T-HF-016-2GHz-xx-Z	SB-P-HF-016-2GHz-xx-Z
 - Plug SE-...	 - Plug SE-...
Max. 16x loaded with: - KS-810-R - HFS-810 305 051 A 5306	Max. 16x loaded with: - SB-810 Z

### Usage

These radio frequency blocks (SB-T/P-HF-...) can be used for the reliable transmission of signals up to 2 GHz. The radio frequency blocks are designed to mount up to 16 transfer contact terminals and can be ordered loaded with between 1 and 16 RF probes (HFS) / contact terminals (KT), according to test requirements. The loading positions for partially loaded radio frequency blocks can be selected as required. Radio frequency blocks up to 2 GHz are offered without centring. Delivery includes mounting materials.

### Technical specifications

#### Radio frequency blocks for up to 2 GHz

- Working distance: 15.1 ± 0.5 mm
- Working stroke: 4.0 mm
- Spring force: up to 84.8 N
- Frequency range: up to 2 GHz
- Impedance: 50 Ω
- Centring range (only for SB-...-Z): ± 0.3 mm
- Operating temperature range: - 30 °C to + 80 °C
- Connection: plug SE-...
- RoHS (2011/65/EC): compliant

### Note:

SE-... plugs with pre-wired RF coaxial cables are not included in the scope of delivery and can be ordered separately (see RF test probe catalogue).

## Ordering information

### Radio frequency blocks SB-T/P-HF-... up to 2 GHz

Radio frequency blocks for test system side SB-T-HF-...		
Part no.	Designation	No. of HFS
38141	SB-T-HF-016-2GHz-01-Z	1
38140	SB-T-HF-016-2GHz-02-Z	2
38139	SB-T-HF-016-2GHz-03-Z	3
38138	SB-T-HF-016-2GHz-04-Z	4
38137	SB-T-HF-016-2GHz-05-Z	5
38136	SB-T-HF-016-2GHz-06-Z	6
38135	SB-T-HF-016-2GHz-07-Z	7
38134	SB-T-HF-016-2GHz-08-Z	8
38133	SB-T-HF-016-2GHz-09-Z	9
38132	SB-T-HF-016-2GHz-10-Z	10
38131	SB-T-HF-016-2GHz-11-Z	11
38130	SB-T-HF-016-2GHz-12-Z	12
38129	SB-T-HF-016-2GHz-13-Z	13
38128	SB-T-HF-016-2GHz-14-Z	14
38127	SB-T-HF-016-2GHz-15-Z	15
34581	SB-T-HF-016-2GHz-Z	16

Radio frequency blocks for DUT side SB-P-HF-...		
Part no.	Designation	No. of KT
38185	SB-P-HF-016-4GHz-01-Z	1
38184	SB-P-HF-016-4GHz-02-Z	2
38183	SB-P-HF-016-4GHz-03-Z	3
38182	SB-P-HF-016-4GHz-04-Z	4
38181	SB-P-HF-016-4GHz-05-Z	5
38180	SB-P-HF-016-4GHz-06-Z	6
38179	SB-P-HF-016-4GHz-07-Z	7
38178	SB-P-HF-016-4GHz-08-Z	8
38177	SB-P-HF-016-4GHz-09-Z	9
38176	SB-P-HF-016-4GHz-10-Z	10
38175	SB-P-HF-016-4GHz-11-Z	11
38174	SB-P-HF-016-4GHz-12-Z	12
38173	SB-P-HF-016-4GHz-13-Z	13
38172	SB-P-HF-016-4GHz-14-Z	14
38171	SB-P-HF-016-4GHz-15-Z	15
34571	SB-P-HF-016-4GHz-Z	16

Series: SB

Design: Radio frequency blocks SB-T/P-HF-...

Number of poles: 1 to 16

Frequency range: 4 GHz

## Radio frequency blocks SB-T/P-HF-... up to 4 GHz

Radio frequency blocks for test system side (SB-T-HF-...)	Radio frequency blocks for DUT side (SB-P-HF-...)
---	---

### 1 to 16-pole radio frequency blocks for up to 4 GHz

SB-T-HF-016-4GHz-xx-Z

SB-P-HF-016-4GHz-xx-Z



– Plug SE-...



– Plug SE-...

Max. 16x loaded with:  
– KS-810-R  
– HFS-840 305 051 A 5306

Max. 16x loaded with:  
– SB-810 Z

## Usage

These radio frequency blocks (SB-T/P-HF-...) can be used for the reliable transmission of signals up to 4 GHz.

The radio frequency blocks are designed to mount up to 16 transfer contact terminals and can be ordered loaded with between 1 and 16 RF probes (HFS) / contact terminals (KT), according to test requirements. The loading positions for partially loaded radio frequency blocks can be selected as required. Radio frequency blocks up to 4 GHz are offered without centring. Delivery includes mounting materials.

## Technical specifications

### Radio frequency blocks for up to 4 GHz

– Working distance:	15.1 ± 0.5 mm
– Working stroke:	4.0 mm
– Spring force:	up to 84.8 N
– Frequency range:	up to 4 GHz
– Impedance:	50 Ω
– Centring range (only for SB-...-Z):	± 0.3 mm
– Operating temperature range:	- 30 °C to + 80 °C
– Connection:	plug SE-...
– RoHS (2011/65/EC):	compliant

### Note:



SE-... plugs with pre-wired RF coaxial cables are not included in the scope of delivery and can be ordered separately (see RF test probe catalogue).



## Ordering information

### Radio frequency blocks SB-T/P-HF-... up to 4 GHz

Radio frequency blocks for test system side SB-T-HF-...		
Part no.	Designation	No. of HFS
38155	SB-T-HF-016-4GHz-01-Z	1
38154	SB-T-HF-016-4GHz-02-Z	2
39681	SB-T-HF-016-4GHz-03-Z	3
38153	SB-T-HF-016-4GHz-04-Z	4
38152	SB-T-HF-016-4GHz-05-Z	5
38151	SB-T-HF-016-4GHz-06-Z	6
38150	SB-T-HF-016-4GHz-07-Z	7
38149	SB-T-HF-016-4GHz-08-Z	8
38148	SB-T-HF-016-4GHz-09-Z	9
38147	SB-T-HF-016-4GHz-10-Z	10
38146	SB-T-HF-016-4GHz-11-Z	11
38145	SB-T-HF-016-4GHz-12-Z	12
38144	SB-T-HF-016-4GHz-13-Z	13
38143	SB-T-HF-016-4GHz-14-Z	14
38142	SB-T-HF-016-4GHz-15-Z	15
34996	SB-T-HF-016-4GHz-Z	16

Radio frequency blocks for DUT side SB-P-HF-...		
Part no.	Designation	No. of KT
38185	SB-P-HF-016-4GHz-01-Z	1
38184	SB-P-HF-016-4GHz-02-Z	2
38183	SB-P-HF-016-4GHz-03-Z	3
38182	SB-P-HF-016-4GHz-04-Z	4
38181	SB-P-HF-016-4GHz-05-Z	5
38180	SB-P-HF-016-4GHz-06-Z	6
38179	SB-P-HF-016-4GHz-07-Z	7
38178	SB-P-HF-016-4GHz-08-Z	8
38177	SB-P-HF-016-4GHz-09-Z	9
38176	SB-P-HF-016-4GHz-10-Z	10
38175	SB-P-HF-016-4GHz-11-Z	11
38174	SB-P-HF-016-4GHz-12-Z	12
38173	SB-P-HF-016-4GHz-13-Z	13
38172	SB-P-HF-016-4GHz-14-Z	14
38171	SB-P-HF-016-4GHz-15-Z	15
34571	SB-P-HF-016-4GHz-Z	16

Radio frequency blocks SB-T/P-HF-... up to 6 GHz	
Radio frequency blocks for test system side (SB-T-HF-...)	Radio frequency blocks for DUT side (SB-P-HF-...)
1 to 8-pole radio frequency blocks for up to 6 GHz	
SB-T-HF-008-6GHz-xx-Z	SB-P-HF-008-6GHz-xx-Z
 – Plug SE-...	 – Plug SE-...
Max. 8x loaded with: – KS-810-R – HFS-860 308 110 A 5342 E1F	Max. 8x loaded with: – SB-860 Z

Radio frequency blocks SB-T/P-HF-... up to 18 GHz	
Radio frequency blocks for test system side (SB-T-HF-...)	Radio frequency blocks for DUT side (SB-P-HF-...)
1 to 4-pole radio frequency blocks for up to 18 GHz	
SB-T-HF-004-18GHz-xx	SB-P-HF-004-18GHz-xx
 – Plug SE-...	 – Plug SE-...
Max. 4x loaded with: – Contact plug 39-BMA-SMA-1: DC (≤ 1.03 + 0.015 f) – Part 37065	Max. 4x loaded with: – Contact bush 37-BMA-SMA-50-1: DC (≤ 1.05 + 0.005 f) – Part 35533

**Usage**

These radio frequency blocks (SB-T/P-HF-...) can be used for the reliable transmission of signals up to 6 GHz or up to 18 GHz. The radio frequency blocks are designed to mount up to 8 or 4 transfer contact terminals and can be ordered loaded with between 1 and 8 RF probes (HFS) / contact terminals (KT) or 1 and 4 contact plugs/bushes, according to test requirements. The loading positions for partially loaded radio frequency blocks can be selected as required. Radio frequency blocks up to 6 GHz are offered with centring and those up to 18 GHz are offered without centring. Delivery includes mounting materials.

**Technical specifications**

**General technical specifications**

- Working distance: 15.1 ± 0.5 mm
- Impedance: 50 Ω
- Connection: plug SE-...
- RoHS (2011/65/EC): compliant

**Radio frequency blocks for up to 6 GHz**

- Working stroke: 4.0 mm
- Spring force: up to 42.4 N
- Frequency range: up to 6 GHz
- Centring range (only for SB-...-Z): ± 0.3 mm
- Operating temperature range: - 30 °C to + 80 °C

**Radio frequency blocks for up to 18 GHz**

- Frequency range: up to 18 GHz
- Centring range (only for SB-...-Z): –
- Operating temperature range: 0 °C to + 80 °C

**Note:**

SE-... plugs with pre-wired RF coaxial cables are not included in the scope of delivery and can be ordered separately (see RF test probe catalogue).

**Ordering information**

**Radio frequency blocks SB-T/P-HF-... up to 6 GHz**

Radio frequency blocks for test system side SB-T-HF-...		
Part no.	Designation	No. of HFS
42218	SB-T-HF-008-6GHz-01-Z	1
42217	SB-T-HF-008-6GHz-02-Z	2
42216	SB-T-HF-008-6GHz-03-Z	3
42215	SB-T-HF-008-6GHz-04-Z	4
41825	SB-T-HF-008-6GHz-05-Z	5
41824	SB-T-HF-008-6GHz-06-Z	6
41823	SB-T-HF-008-6GHz-07-Z	7
41165	SB-T-HF-008-6GHz-Z	8

Radio frequency blocks for DUT side SB-P-HF-...		
Part no.	Designation	No. of KT
42717	SB-P-HF-008-6GHz-01-Z	1
42716	SB-P-HF-008-6GHz-02-Z	2
42708	SB-P-HF-008-6GHz-03-Z	3
42707	SB-P-HF-008-6GHz-04-Z	4
42706	SB-P-HF-008-6GHz-05-Z	5
42629	SB-P-HF-008-6GHz-06-Z	6
42628	SB-P-HF-008-6GHz-07-Z	7
42627	SB-P-HF-008-6GHz-Z	8

**Radio frequency blocks SB-T/P-HF-... up to 18 GHz**



Radio frequency blocks for test system side SB-T-HF-...		
Part no.	Designation	No. of HFS
55754	SB-T-HF-004-18GHz-01	1
55755	SB-T-HF-004-18GHz-02	2
55756	SB-T-HF-004-18GHz-03	3
35534	SB-T-HF-004-18GHz	4



Radio frequency blocks for DUT side SB-P-HF-...		
Part no.	Designation	No. of KT
55751	SB-P-HF-004-18GHz-01	1
55752	SB-P-HF-004-18GHz-02	2
55753	SB-P-HF-004-18GHz-03	3
35532	SB-P-HF-004-18GHz	4



Series: SB



Design: Fibre optic blocks SB-T/P-LL-...

Number of poles: 20 | 24 | 45

Fibre optic blocks SB-T/P-LL-...	
Fibre optic blocks for test system side (SB-T-LL-...)	Fibre optic blocks for DUT side (SB-P-LL-...)
<b>24-pole fibre optic blocks for FOC with 1.5 mm COD</b>	
<b>SB-T-LL-024-DK1,5-Z</b>	<b>SB-P-LL-024-DK1,5-Z</b>
 <ul style="list-style-type: none"> <li>– Receptacle</li> <li>– Spring-loaded</li> </ul> 24× loaded with: – Receptacle Part 22042	 <ul style="list-style-type: none"> <li>– Receptacle</li> </ul> 24× loaded with: – Receptacle Part 22042
To be loaded with fibre optic cable with 2.3 mm CLD, which should be stripped to Ø 1.5 mm over a length of approx. 4.3 mm.	

45-pole fibre optic blocks for FOC with 2.3 mm CLD	
SB-T-LL-045-DM2,3-K	SB-P-LL-045-DM2,3
 <ul style="list-style-type: none"> <li>– Receptacle</li> <li>– Cellular rubber</li> </ul> 45× loaded with: – KS-004 35 G-K	 <ul style="list-style-type: none"> <li>– Receptacle</li> </ul> 45× loaded with: – KS-004 35 G-K
To be loaded with fibre optic cable with 2.3 mm CLD	

45-pole fibre optic blocks for FOC with 1.0 mm CLD	
SB-T-LL-045-DM1,0-K	SB-P-LL-045-DM1,0
 <ul style="list-style-type: none"> <li>– Receptacle</li> <li>– Cellular rubber</li> </ul> 45× loaded with: – KS-075 35 K-LWL	 <ul style="list-style-type: none"> <li>– Receptacle</li> </ul> 45× loaded with: – KS-075 35 K-LWL
To be loaded with fibre optic cable with 1.0 mm cladding diameter	

20-pole fibre optic blocks 20-pole for Feasa Optical Heads OH-3		
SB-T-LL-020-OH3-K	SB-P-LL-045-DM2,3	SB-P-LL-045-DM1,0
 <ul style="list-style-type: none"> <li>– Mounting hole Ø 4.8 mm</li> <li>– Cellular rubber</li> </ul> Prepared to be loaded with up to 20 pcs of: – Feasa Optical Head OH-3	 <ul style="list-style-type: none"> <li>– Receptacle</li> </ul> 45× loaded with: – KS-004 35 G-K To be loaded with fibre optic cable with: CLD = 2.3 mm	 <ul style="list-style-type: none"> <li>– Receptacle</li> </ul> 45× loaded with: – KS-075 35 K-LWL To be loaded with fibre optic cable with: CLD = 1.0 mm

## Usage

Fibre optic blocks (SB-T/P-LL-...) can be used for the reliable transmission of optical signals. Fibre optic blocks are primarily used for testing light-emitting components such as LEDs.

Blocks are delivered fully loaded, ready to mount fibre optic cables or Feasa Optical Heads OH-3, and mounting materials are included.

## Technical specifications

### Fibre optic blocks SB-T/P-LL-...

- Working distance: 15.1 ± 0.5 mm
- Centring range (only for SB-...-Z): ± 0.3 mm
- Operating temperature range: - 30 °C to + 80 °C compliant
- RoHS (2011/65/EC): compliant

### Fibre optic block SB-T-LL-024-DK1,5-Z

- Sealing: spring-loaded
- Fibre optic cable diameter: CLD = 2.3 mm

### Fibre optic block SB-T-LL-045-DM2,3-K

- Sealing: cellular rubber
- Fibre optic cable diameter: CLD = 2.3 mm

### Fibre optic block SB-T-LL-045-DM1,0-K

- Sealing: cellular rubber
- Fibre optic cable diameter: CLD = 1.0 mm

### Fibre optic block SB-T-LL-020-OH3-K

- Sealing: cellular rubber
- Fibre optic cable diameter: –

## Note:

Fibre optic cables and Feasa Optical Heads OH-3 as an integral part of Feasa LED analysers are not included in the scope of delivery. Fibre optic cables and Feasa LED analysers with OH-3 optical heads can be found on page 209.



## Abbreviations:



FOC = fibre optic cable | CLD = cladding diameter | COD = core diameter

## Ordering information

Fibre optic blocks for test system side SB-T-LL-...					
Part no.	Designation	No. of KS	FOC CLD	Connection	No. SB-P-LL-...
30210	SB-T-LL-024-DK1,5-Z	24	2.3 mm	Receptacle	1
27618	SB-T-LL-045-DM2,3-K	45	2.3 mm	Receptacle	2
41017	SB-T-LL-045-DM1,0-K	45	1.0 mm	Receptacle	3
38696	SB-T-LL-020-OH3-K	Prepared for max. 20× OH-3	–	Mounting hole Ø 4.8 mm	2   3

Fibre optic blocks for DUT side SB-P-LL-...					
Part no.	Designation	No. of KS	FOC CLD	Connection	No.
30211	SB-P-LL-024-DK1,5-Z	24	2.3 mm	Receptacle	1
29448	SB-P-LL-045-DM2,3	45	2.3 mm	Receptacle	2
41020	SB-P-LL-045-DM1,0	45	1.0 mm	Receptacle	3

Pneumatic blocks SB-T/P-PN-...	
Pneumatic blocks for test system side (SB-T-PN-...)	Pneumatic blocks for DUT side (SB-P-PN-...)
8-pole pneumatic blocks	
SB-T-PN-008-PK3	SB-P-PN-008-PK3
 – Plug nipple	 – Plug nipple
8× loaded with: – KSV-PK-3 (part 21085)	8× loaded with: – KDV-PK-3 (part 21084)
To be loaded with compressed air hose, e.g. PUN-4x0,75-BL	

8-pole pneumatic blocks with compressed air locking	
SB-T-PN-008-PK3-A	SB-P-PN-008-PK3-A
 – Plug nipple – Compressed air locking	 – Plug nipple
8× loaded with: – Contact bush (part 37819)	8× loaded with: – Contact plug (part 37818)
To be loaded with compressed air hose, e.g. PUN-4x0,75-BL	

**Usage**

Pneumatic blocks (SB-T/P-PN-...) can be used for the reliable transmission of compressed air. Compressed air is always needed when testing involves pneumatic functional units, such as is the case for pneumatic test probes or pneumatic marking units, for example. Blocks are delivered fully loaded, ready to mount compressed air hoses, and mounting materials are included.

**Technical specifications**

**Pneumatic blocks 8-pole**

- Working distance: 15.1 ± 0.5 mm
- Recommended air pressure: 0.6 MPa
- Compressed air quality: ISO 8573-1:2010
- Compressed air connection: PK-3
- Compressed air locking (SB-T-PN-...): –
- Operating temperature range: - 30 °C to + 120 °C
- Connection: plug nipple
- RoHS (2011/65/EC): compliant

**Pneumatic blocks 8-pole with compressed air locking**

- Working distance: 15.1 ± 0.5 mm
- Recommended air pressure: 0.6 MPa
- Compressed air quality: ISO 8573-1:2010
- Compressed air connection: PK-3
- Compressed air locking (SB-T-PN-...): included
- Connection cycles (laboratory conditions): > 500
- Operating temperature range: - 30 °C to + 120 °C
- Connection: plug nipple
- RoHS (2011/65/EC): compliant

**Customisation example**

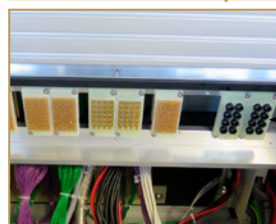

Interface blocks  
 SB-T-PN-008-PK3-A (part 37820)

Internal interface on  
 MA 2113/D/H/S-10 loaded with  
 interface blocks (SB-T-...)

**Note:**







Compressed air hoses are not included in the scope of delivery. Suitable compressed air hoses (PUN) can be found on page 209.

**Ordering information**

Pneumatic blocks for test system side SB-T-PN-...		
Part no.	Designation	No. of loaded components
27630	SB-T-PN-008-PK3	8
37820	SB-T-PN-008-PK3-A – Incl. compressed air locking	8

Pneumatic blocks DUT side SB-P-PN-...		
Part no.	Designation	No. of loaded components
27622	SB-P-PN-008-PK3	8
37821	SB-P-PN-008-PK3-A	8

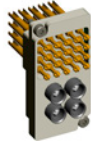

Mixed blocks SB-T/P-MB-...	
Mixed blocks for test system side (SB-T-MB-...)	Mixed blocks for DUT side (SB-P-MB-...)
20-pole mixed blocks with high current and 20-pole fibre optic connection	
<b>SB-T-MB-20/20-30A/DM2,3-K</b>	<b>SB-P-MB-20/20-30A/DM2,3</b>
 <ul style="list-style-type: none"> <li>- Solder cup</li> <li>- Receptacle</li> <li>- Cellular rubber</li> </ul> <p>20x loaded with:                      - KS-113 30 M2-R                      - HSS-120 317 300 A 1502 M                      20x loaded with:                      - KS-004 35 G-K</p>	 <ul style="list-style-type: none"> <li>- Solder cup</li> <li>- Receptacle</li> </ul> <p>20x loaded with:                      - KT-120 L3 E02-30                      20x loaded with:                      - KS-004 35 G-K</p>
To be loaded with fibre optic cable with 2.3 mm CLD	
20-pole mixed blocks with high current and 4-pole pneumatic connection	
<b>SB-T-MB-20/4-30A/PK3</b>	<b>SB-P-MB-20/4-30A/PK3</b>
 <ul style="list-style-type: none"> <li>- Solder cup</li> <li>- Plug nipple</li> </ul> <p>20x loaded with:                      - KS-113 30 M2-R                      - HSS-120 317 300 A 1502 M                      4x loaded with:                      - KSV-PK-3 (part 21085)</p>	 <ul style="list-style-type: none"> <li>- Solder cup</li> <li>- Plug nipple</li> </ul> <p>20x loaded with:                      - KT-120 L3 E02-30                      4x loaded with:                      - KDV-PK-3 (part 21084)</p>
To be loaded with compressed air hose, e.g. PUN-4x0,75-BL	
20-pole mixed blocks with high current and 4-pole pneumatic connection with compressed air locking	
<b>SB-T-MB-20/4-30A/PK3-A</b>	<b>SB-P-MB-20/4-30A/PK3-A</b>
 <ul style="list-style-type: none"> <li>- Solder cup</li> <li>- Plug nipple</li> <li>- Compressed air locking</li> </ul> <p>20x loaded with:                      - KS-113 30 M2-R                      - HSS-120 317 300 A 1502 M                      4x loaded with:                      - Contact bush (part 37819)</p>	 <ul style="list-style-type: none"> <li>- Solder cup</li> <li>- Plug nipple</li> </ul> <p>20x loaded with:                      - KT-120 L3 E02-30                      4x loaded with:                      - Contact plug (part 37818)</p>
To be loaded with compressed air hose, e.g. PUN-4x0,75-BL	

## Usage

With mixed blocks (SB-T/P-MB-...), a combination of various signals can be reliably transmitted with just a single interface block. Mixed block designs include high current combined with either fibre optic or pneumatic connections are available.

Blocks are delivered fully loaded, ready to mount fibre optic cables or compressed air hoses, and mounting materials are included.

## Technical specifications

### Mixed blocks SB-T/P-MB-...

- Working distance: 15.1 ± 0.5 mm
- Working stroke: 4.0 mm
- RoHS (2011/65/EC): compliant

### High current connection

- Spring force: 30 N
- Shortest distance btw. KS/KT (unwired): 1.48 mm
- Ri typical one test probe: ≤ 10 mΩ
- Max. rated current one test probe: 30 A
- Max. rated current of all test probes: 10 A (200 A)
- Max. power loss: 25 W
- Max. permitted voltage: 1,180 V
- Min. cable cross-section: 1.5 mm<sup>2</sup>
- Connection: solder cup

### Combined with fibre optic connection

- Sealing: cellular rubber
- Fibre optic cable diameter: CLD = 2.3 mm
- Operating temperature range: - 30 °C to + 80 °C
- Connection: receptacle

### Combined with pneumatic connection



- Recommended air pressure: 0.6 MPa
- Compressed air quality: ISO 8573-1:2010
- Compressed air connection: PK-3
- Operating temperature range: - 30 °C to + 120 °C
- Connection: plug nipple

## Note:

Fibre optic cables and compressed air hoses are not included in the scope of delivery. Suitable fibre optic cables and compressed air hoses (PUN) can be found on page 209.

## Ordering information

Mixed blocks for test system side SB-T-MB-...				Mixed blocks for DUT side SB-P-MB-...			
Part no.	Designation	Loading	Connection	Part no.	Designation	Loading	Connection
45303	SB-T-MB-20/20-30A/DM2,3-K	20/20	- Solder cup - Receptacle	45305	SB-P-MB-20/20-30A/DM2,3	20/20	- Solder cup - Receptacle
32020	SB-T-MB-20/4-30A/PK3	20/4	- Solder cup - Plug nipple	31867	SB-P-MB-20/4-30A/PK3	20/4	- Solder cup - Plug nipple
50582	SB-T-MB-20/4-30A/PK3-A - Incl. compressed air locking	20/4	- Solder cup - Plug nipple	50581	SB-P-MB-20/4-30A/PK3-A	20/4	- Solder cup - Plug nipple

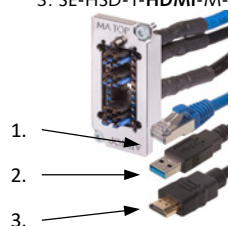
HSD-Blöcke SB-B-HSD-...	
HSD blocks for test system side (SB-B-HSD-...)	HSD blocks for DUT side (SB-B-HSD-...)
HSD blocks with 11 slots	
SB-B-HSD-011	
	
Mounting on basic unit with alignment <b>MA TOP</b> at the top	Mounting on exchangeable kit with alignment <b>ATS TOP</b> at the top
Modular design with 11 slots, prepared to mount HSD interface cables, such as: 1. SE-HSD-T-RJ45-M-183, 2. SE-HSD-T-USB3A-M-183, 3. SE-HSD-T-HDMI-M-183	
	

**Mounting/operation:**

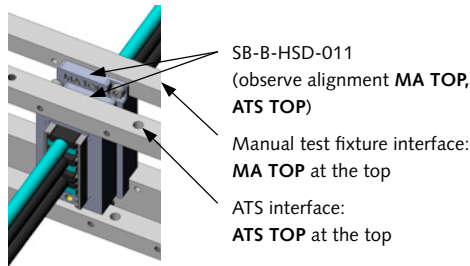

To operate, 2 HSD interface blocks and at least 2 HSD interface cables (1x SE-HSD-T-... and 1x SE-HSD-P-...) are required. When mounting the HSD blocks, observe the correct alignment: **MA TOP** at the top for the test system side and **ATS TOP** at the top for mounting on the DUT side.

**Usage**

HSD interface blocks (SB-B-HSD-...) are used for the reliable transmission of HSD (High Speed Digital) signals. Thanks to their modular design, the HSD interface blocks can be loaded with various HSD interface cables, including RJ45, USB3.0-A or HDMI, as required. Matching contact strokes guarantee continually reliable contact quality with a gross data rate of up to 12.5 Gbit/s. The HSD interface blocks can be used in all manual test fixtures in the series MA 21xx and 32xx. Blocks are delivered fully loaded, ready to mount HSD interface cables, and mounting materials are included.

**Technical specifications**

**HSD interface blocks**

- Slots available for loading: 11
- Gross data rate: up to 12.5 Gbit/s
- Number of connection cycles: approx. 10,000

**Customisation example**

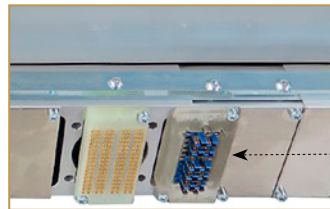

Pylon interface on MA 2112/D/H/S-7 loaded with interface blocks (SB-T-...)

Interface block SB-B-HSD-011 (part 50917)

**Note:**

- SB-B-HSD-...: HSD interface block for test system or DUT side mounting on the MA or ATS interface
- SE-HSD-T-...: HSD interface cable for MA interface-mounted HSD interface blocks
- SE-HSD-P-...: HSD interface cable for ATS interface-mounted HSD interface blocks
- SE-...-M-xxx: Cable length in cm

**Ordering information**

HSD blocks for the test system side and DUT side SB-B-HSD-...			
Part no.	Designation	Loading	Slots
50917	SB-B-HSD-011	Ready to mount HSD interface cables	11

HSD interface cables for the test system side and DUT side SE-HSD-T/P-...					
RJ45 interface cable (requires 2 slots)					
Part no.	Designation	Mounting	Part no.	Designation	Mounting
51417	SE-HSD-T-RJ45-M-183	Test system side	51418	SE-HSD-P-RJ45-M-030	DUT side
			51419	SE-HSD-P-RJ45-M-060	DUT side



USB 3.0-A interface cable (requires 2 slots)					
Part no.	Designation	Mounting	Part no.	Designation	Mounting
51420	SE-HSD-T-USB3A-M-183	Test system side	51421	SE-HSD-P-USB3A-M-030	DUT side
			51422	SE-HSD-P-USB3A-M-060	DUT side



HDMI interface cable (requires 3 slots)					
Part no.	Designation	Mounting	Part no.	Designation	Mounting
51423	SE-HSD-T-HDMI-M-183	Test system side	51424	SE-HSD-P-HDMI-M-030	DUT side
			51425	SE-HSD-P-HDMI-M-060	DUT side

**Series:** SB  
**Design:** Special blocks SB-P-SO-...  
**Mounting:** DUT side

## Special blocks SB-P-SO-...

Special blocks for **DUT side**  
 (SB-P-SO-...)

Special block pole terminal	Special block D-sub socket
<b>SB-P-SO-002-Pole terminal</b>	<b>SB-P-SO-009-SUB-D</b>
 <p>- Pole terminals</p> <p>2× loaded with:                      - 1× pole terminal red, Ø 4.0 mm (part 8847)                      - 1× pole terminal black, Ø 4.0 mm (part 3645)</p>	 <p>- Sub-D socket</p> <p>1× loaded with:                      - 1× sub-D socket, 9-pole (part 29629)</p>

Special block IDC socket	Special block USB socket
<b>SB-P-SO-0xx-IDC</b>	<b>SB-P-SO-002-USB</b>
 <p>- IDC socket</p> <p>1× loaded with:                      - 1× IDC socket                      - Available with 10, 16, 20 or 26 poles</p>	 <p>- USB 2.0 A-B socket</p> <p>2× loaded with:                      - USB 2.0 A-B socket (part 27418)</p>

**Special block USB/RJ45 socket**

**SB-P-SO-002-USB-RJ45**



- USB 2.0 A-A socket  
 - RJ45 socket

2× loaded with:  
 - 1× USB 2.0 A-A socket (part 54751)  
 - 1× RJ45 socket (part 54750)

### Usage

Special blocks (SB-P-SO-...) are used as electrically conductive connectors between the test device and the test system for the transmission of various signals.

Special blocks are available only for DUT-side mounting. Blocks are delivered fully loaded, and mounting materials are included.

### Customisation example

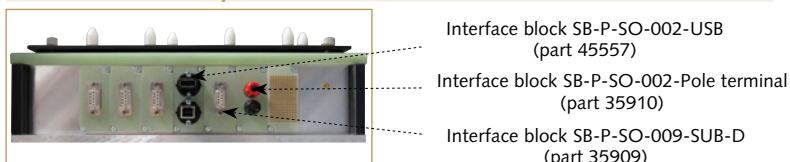

Internal interface on  
 ATS MA12/S-7 loaded with  
 interface blocks (SB-P-...)

## Ordering information

Special blocks for DUT side SB-P-SO-...					
Part no.	Designation	Number / type of socket		Temperature range	RoHS (2011/65/EC)
35910	SB-P-SO-002-Pole terminal	2	- Pole terminal red, Ø 4 mm (part 8847) - Pole terminal black, Ø 4 mm (part 3645)	- 20 °C to +100 °C	Compliant
35909	SB-P-SO-009-SUB-D	1	D-sub socket, 9-pole (part 29629)	- 20 °C to +100 °C	Compliant
37662	SB-P-SO-010-IDC	1	IDC socket, 10-pole (part 11937)	- 20 °C to +100 °C	Compliant
56990	SB-P-SO-016-IDC	1	IDC socket, 16-pole (part 56693)	- 20 °C to +100 °C	Compliant
56694	SB-P-SO-020-IDC	1	IDC socket, 20-pole (part 56697)	- 20 °C to +100 °C	Compliant
56698	SB-P-SO-026-IDC	1	IDC socket, 26-pole (part 56701)	- 20 °C to +100 °C	Compliant
45557	SB-P-SO-002-USB	2	USB 2.0 A-B socket (part 27418)	- 25 °C to + 85 °C	Compliant
54752	SB-P-SO-002-USB-RJ45	2	USB 2.0 A-A socket (part 54751) RJ45 socket (part 54750)	- 20 °C to + 50 °C	Compliant

## Cable connections Dummy panels

### Cable connections



- Pre-wired with 4× 16-pole socket strips and 1× 64-pole female socket connector (DIN 41612)

Flat ribbon cable 64-pole



- Pre-wired with 10× yellow litz wires AWG 26

Plug connector 10-pole



- Pre-wired with 10× green litz wires AWG 26

### Dummy panels

For covering free, non-configured interface block slots on internal and external Pylon interfaces.

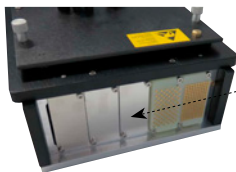

- Dummy panels mounted on ATS MA11/S-5/ESD

### Usage

For wiring the interface blocks, we offer low-wear plug connections that can be released quickly without any tools as an alternative to conventional wire wrap connections.

This is supplied as a 64-pole flat ribbon cable, pre-wired with socket strips and a multipoint connector, or 10-pole plug connector, pre-wired with litz wire cables.

### Connection examples



Interface block SB-T-SI-170-4A (part 27616) wired with 64-pole flat ribbon cable (part 33175)

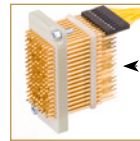

Interface block SB-T-SI-170-4A (part 27616), wired with 10-pole plug connector, litz wires yellow (part 43371)

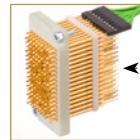

Interface block SB-T-SI-170-4A (part 27616), wired with 10-pole plug connector, litz wires green (part 43372)

## Ordering information

64-pole flat ribbon cable, pre-wired with 4× 16-pole socket strips and 1× 64-pole female socket connector (DIN 41612)						
Part no.	Configuration	Cable length	Cable cross-section	Current load capacity	Cable colour	Temperature range
33175	a/c	approx. 700 mm	AWG 28	1.5 A	Grey	- 5 °C to + 105 °C

10-pole plug connector, pre-wired with 10 litz wires						
Part no.	Cable length	Cable cross-section	Current load capacity	Cable colour	Temperature range	
43371	approx. 700 mm	AWG 26	2 A	Yellow	- 5 °C to + 105 °C	
43372	approx. 700 mm	AWG 26	2 A	Green	- 5 °C to + 105 °C	

Litz wires, AWG 26, pre-wired with crimp contact						
Part no.	Cable length	Cable cross-section	Current load capacity	Cable colour	Temperature range	
43373	approx. 700 mm	AWG 26	2 A	Black	- 5 °C to + 105 °C	
43374	approx. 700 mm	AWG 26	2 A	Yellow	- 5 °C to + 105 °C	
43375	approx. 700 mm	AWG 26	2 A	Red	- 5 °C to + 105 °C	
43376	approx. 700 mm	AWG 26	2 A	Green	- 5 °C to + 105 °C	

10-pole socket housing (single-row)					
Part no.	Number of poles	Grid	Current load capacity	Housing colour	Temperature range
43377	10 (single-row)	2.54 mm	3 A	Black	- 25 °C to + 105 °C

Dummy panels (without mounting materials)			
Part no.	Outer dimensions (W × D × H)	Mounting hole	Material
2487	28.6 × 1.5 × 60 mm	2× Ø 3.2 mm	Aluminium

## Designation/mounting

INGUN interface blocks are abbreviated as **SB-...** and a distinction is made between interface blocks which are mounted on the test system side (**SB-T-...**) and interface blocks which are mounted on the DUT side (**SB-P-...**). In each case, one interface block is loaded with spring-loaded test probes while the other has rigid contact terminals or pneumatic/fibre optic cable couplings.

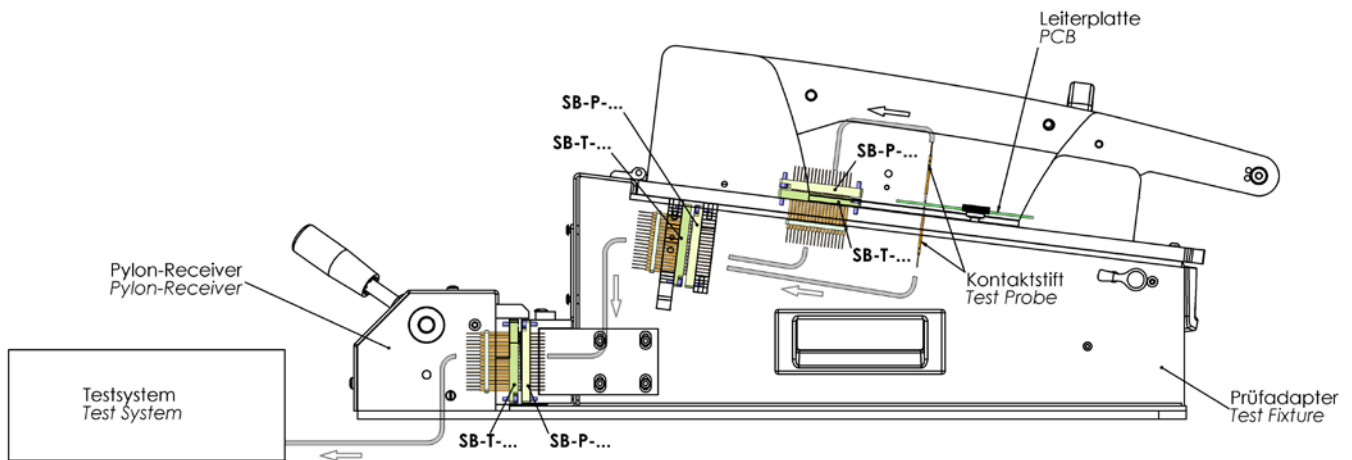

Mounting the interface blocks SB-T... (test system side) and SB-P... (DUT side)

## Wiring plan (viewed from wiring side)

For all interface blocks, the vertical rows are identified by letters and the horizontal rows by numbers. Numbering starts at the test system-side interface block at the top right and the DUT-side interface block at the top left, as viewed in each case from the wiring side.

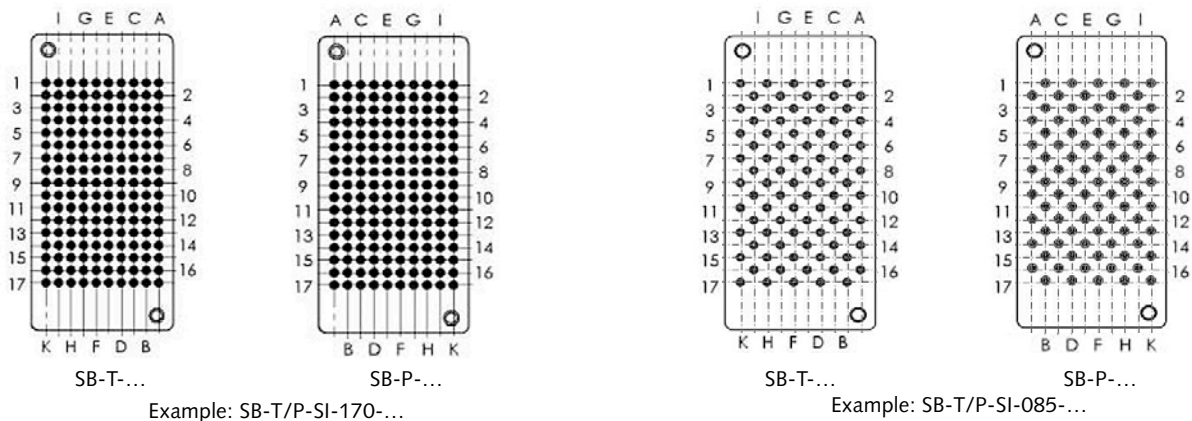

## Power loss

Before using the interface blocks, calculations must be made to verify that the current to be transmitted does not exceed the stated power loss. The power loss is the power converted into heat and is definitive for the max. current load capacity of the interface block pairs used. The power loss is calculated by the formula:  **$P = I^2 \cdot \text{number of test probes} \cdot R$**

### Sample calculation:

With a 170-pole low-impedance interface block, 20 probes are to be connected.

How high is the max. current per test probe?

$$I = \sqrt{P / (\text{number of test probes} \times R)} = \sqrt{5 \text{ W} / (20 \times 0.01 \Omega)} = 5 \text{ A} > 4 \text{ A (!)}$$

$$P = (4 \text{ A})^2 \times 20 \times 0.01 \Omega = 3.2 \text{ W} < 5 \text{ W}$$

The maximum current per test probe is 4 A, since a test probe is designed for a max. rated current of 4 A and therefore the maximum power loss of 5 W may not be exceeded.

## Air distance (max. voltage)

Before using the interface blocks, calculations must be made to verify that the voltages to be transmitted do not exceed the stated voltages by a wired smaller air distance. The air distance is the shortest distance between two conductive components and definitive for the maximum voltage of the interface block pairs that are used. To calculate the voltage flashover of sharp components in air under standard conditions, the rule of thumb is: **approx. 0.8 kV per 1 mm of distance**

### Sample calculation:

How high is the maximum voltage to be transmitted with a 170-pole low-impedance interface block?

$$0.34 \text{ mm (air distance, unwired)} \times 0.8 \text{ kV} \approx 270 \text{ V}$$

The maximum voltage to be transmitted may not exceed 270 V with an air distance (unwired) of 0.34 mm.



# Marking units

## Reliable, permanent marking with compact units

**Electrical marking units (ME-E)**



ME-E-R2,0-12-060-K12V



ME-E-S2,0-12-060-K12V



ME-E-R2,0-12-100-K12V



ME-E-R2,0-12-080-S12V

**Pneumatic marking units (ME-P)**



ME-P-S2,0-16-054-QS4



ME-P-F1,0-16-054-QS4

**Extraction devices (ASV)**



ASV-ME-x-Wx-EC

**Usage**

Marking units (ME) are intended for the reliable marking of PC boards, tested and found to be "good", with a permanent mark in the shape of a circle or a circular point.

Marking units are installed in a test fixture or an exchangeable kit, are space saving, and can be precisely positioned.

Electrical marking units (ME-E) and pneumatic marking units (ME-P) are available.

**Determinant features**

- Compact, robust design
- Precise, continuously variable positioning
- High resistant to abrasion and wear
- Electrically or pneumatically operated
- Outstanding life span
- Permanent marking on a wide variety of materials, such as
  - Plastics (FR4, CEM-1, ...)
  - Non-hardened metals (brass, aluminium, ...)
  - Paper labels

**Life span**

- ME-E: 500,000 load cycles (laboratory conditions)
  - ME-P: 150,000 load cycles (laboratory conditions)
- The life span is determined in the laboratory with fully automatic, computer-controlled endurance test stations under full load. Since the life span depends on many different factors and in particular on the individual test application, INGUN cannot guarantee the actual duration of use in the test field.

**Suction devices**

Suction devices can be used to keep any undesirable contamination caused by the marking process to a minimum. The shavings created are extracted by a vacuum suction nozzle by applying the familiar Venturi principle and routed via a suction head to a collection container with a filter element, where they are collected. The collection container can be removed without any tools and emptied easily.

- Quick, simple mounting
- Collection container can be removed without any tools

**Electrical marking units (ME-E)**

ME-E-R2,0-12-060-K12V	172
ME-E-S2,0-12-060-K12V	172
ME-E-R2,0-12-100-K12V	172
ME-E-R2,0-12-080-S12V	172

**Accessories for ME-E**

SE-M12-04-F-W-200	173
SWS-ME-E-R2,0	173
ASV-ME-E-WK-EC	173
ASV-ME-E-WL-EC	173

**Pneumatic marking units (ME-P)**

ME-P-S2,0-16-054-QS4	174
ME-P-F1,0-16-054-QS4	174

**Accessories for ME-P**

SD-SB-01-07-D16-15	175
ASV-ME-P-WK-EC	175
MHE2-M1H-3/2G-QS-4-K	175

**Note**

For overview and comparison table see pages 176 to 177.

Series: ME

Type: Electrical marking units (ME-E)

Drive: Electric gear motor

Marking head: Scratching engraver | cutting engraver

## Electrical marking units (ME-E)

### ME-E-R2,0-12-060-K12V

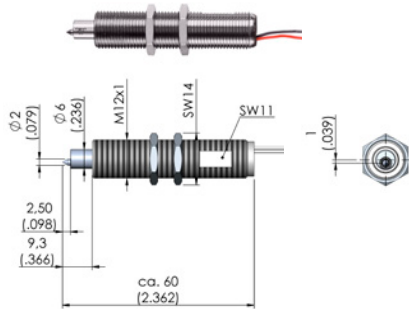

### ME-E-S2,0-12-060-K12V

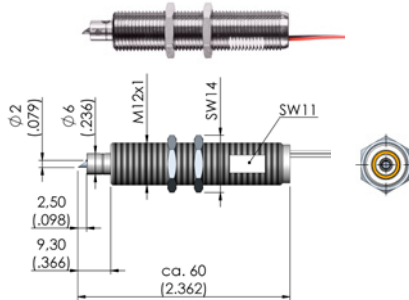

### ME-E-R2,0-12-100-K12V

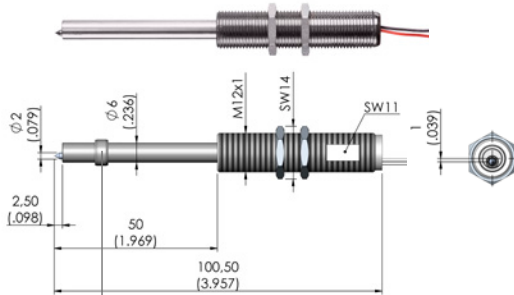

#### Recommendation:

Guide front part of engraver shaft with friction bearing (part 38377) provided.

### ME-E-R2,0-12-080-S12V

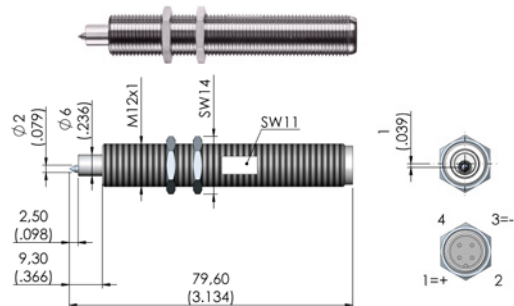

Plug connector  
SE-M12-04-F-W-200

## Function

The spring-loaded marking engraver is pressed against the surface of the electronic unit during testing. In its connected state, the marking unit is provided with 12 V DC for about 1 second. The rotational movement produced causes the electronic unit to be permanently marked.

## Technical specifications

### ME-E-R2,0-12-060-K12V

- Outer dimensions (D × L): approx.  $\phi 12 \times 60$  mm
- Weight: approx. 0.04 kg
- Drive connection: cable
- Marking head: scratching engraver ✓
- Spare part engraver kit: ✓
- Materials: hard and soft materials

### ME-E-S2,0-12-060-K12V

- Outer dimensions (D × L): approx.  $\phi 12 \times 60$  mm
- Weight: approx. 0.04 kg
- Drive connection: cable
- Marking head: cutting engraver
- Spare part engraver kit: –
- Materials: soft materials

### ME-E-R2,0-12-100-K12V

- Outer dimensions (D × L): approx.  $\phi 12 \times 100$  mm
- Weight: approx. 0.05 kg
- Drive connection: cable
- Marking head: scratching engraver ✓
- Spare part engraver kit: ✓
- Materials: hard and soft materials

### ME-E-R2,0-12-080-S12V

- Outer dimensions (D × L): approx.  $\phi 12 \times 80$  mm
- Weight: approx. 0.05 kg
- Drive connection: plug connector
- Marking head: scratching engraver ✓
- Spare part engraver kit: ✓
- Materials: hard and soft materials

## General characteristic data

- Outer thread: M12 × 1
- Lock nut: size 14
- Operating temperature range: - 20 °C to + 65 °C
- Recommended working stroke: approx. (-) 1.5 mm
- Maximum stroke: approx. (-) 2.0 mm
- Recommended marking impulse: approx. 1.0 s
- Force at working stroke: approx. 3.0 N
- Engraver material: solid carbide
- Engraver hardness: approx. 1,600 HV
- Marking: circle, approx.  $\phi 2.0$  mm
- RoHS (2011/65/EC): compliant
- CE (2006/42/EC): partly completed machinery

## Drive specifications

- Drive (\*): electric gear motor
- Rated voltage (\*\*): 12 V DC
- Rated output: 0.75 W
- No-load current: 3.68 mA
- Starting current: 106 mA
- Connection resistance: 114  $\Omega$
- Max. constant load current: 81 mA
- Max. torque: 54 mNm
- Idle speed: approx. 180 RPM
- Noise emission: not relevant

## Electrical marking units (ME-E)

### Installation

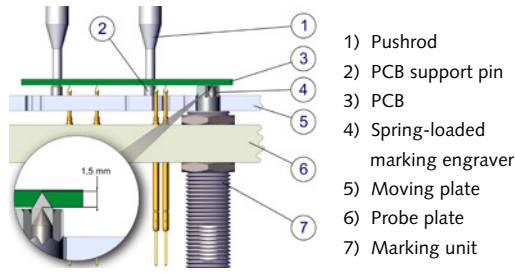

### Installation

When contacting the electronic unit, install the electrical marking units so that the spring-loaded marking engraver is pressed in to approx. 1.5 mm of its working stroke and oriented vertically to the marking surface. In order to avoid damage to the gears in the drive system, the maximum stroke of approximately 2.0 mm must not be exceeded. Use the M12 outer thread, which is freely adjustable in terms of height, to mount the marking unit on the probe plate (from below) or pressure frame plate (from above). Please note that the core diameter in the probe plate is to be realised with  $\varnothing 11.0 \text{ mm} + 0.3 \text{ mm}$

### Spare part engraver kit

A spare part engraver kit (SWS) consisting of a friction bearing, marking engraver and spring is available for the electrical marking units 24447, 24456 and 38371.

### Spare part engraver kit

#### SWS-ME-E-R2,0

– Suitable for parts: 24447, 24456, 38371

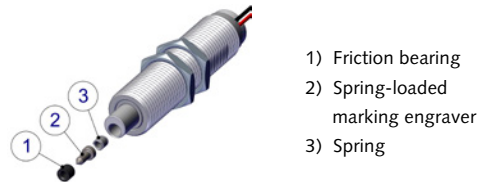

### Suction devices

Suction devices (ASV) to extract the shavings produced during the marking process are available for the electrical marking units.

### Suction devices

#### ASV-ME-E-WK-EC

– Suitable for parts: 24447, 25251, 38371  
– Outer dims. (W × D × H): approx. 120 × 37 × 80 mm  
– Suction head (W × D): approx. 16 × 28 mm  
– Operating pressure: 0.6 MPa

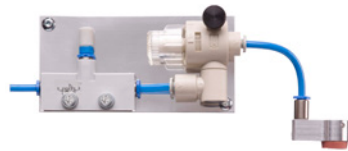

#### ASV-ME-E-WL-EC

– Suitable for parts: 24456  
– Outer dims. (W × D × H): approx. 120 × 37 × 80 mm  
– Suction head (W × D): approx. 16 × 28 mm  
– Operating pressure: 0.6 MPa

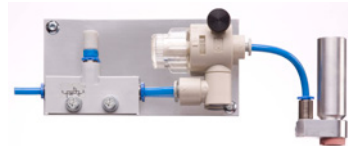

### Customisation example

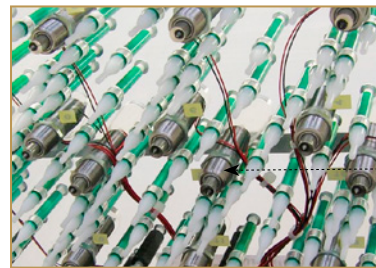

Electrical marking unit (part 24447)

Top contacting with electrical marking units (ME-E)

#### \* Current limiting:

To avoid damage to the drive system used with the electrical marking units caused by electrical overload, we recommend limiting the current to approx. 100 mA as a precaution.

#### \*\* 24 V DC operation:

Although 12 V DC is specified, the operation of the electrical marking units with 24 V DC is also possible. However, it should be noted that doing so will increase the wear on the gears as well as the motor considerably. This will reduce the life expectancy of the entire system by approximately 25%. The reason for this is primarily the brush sparking of the start-stop operation, the motor's doubled torque in the end position (marking the PCB) and the increased inertia, which has a multiplying effect on the whole system in terms of wear.

## Ordering information

Electrical marking units (ME-E)		
Part no.: 24447	ME-E-R2,0-12-060-K12V	Scratching engraver, hard and soft materials
Part no.: 25251	ME-E-S2,0-12-060-K12V	Cutting engraver, soft materials
Part no.: 24456	ME-E-R2,0-12-100-K12V	Scratching engraver, hard and soft materials, long, narrow shaft
Part no.: 38371	ME-E-R2,0-12-080-S12V	Scratching engraver, hard and soft materials, plug connector connection
Accessories		
Part no.: 43637	SE-M12-04-F-W-200	Plug connector, angled, 2 m cable, suitable for part 38371
Part no.: 27316	SWS-ME-E-R2,0	Spare part engraver kit, suitable for parts 24447, 24456 and 38371
Part no.: 36797	ASV-ME-E-WK-EC	Suction device, suitable for parts 24447, 25251 and 38371
Part no.: 37021	ASV-ME-E-WL-EC	Suction device, suitable for part 24456

Series: ME

Type: Pneumatic marking units (ME-P)

Drive: Compressed air motor

Marking head: Cutting engraver | milling engraver

## Pneumatic marking units (ME-P)

### ME-P-S2,0-16-054-QS4

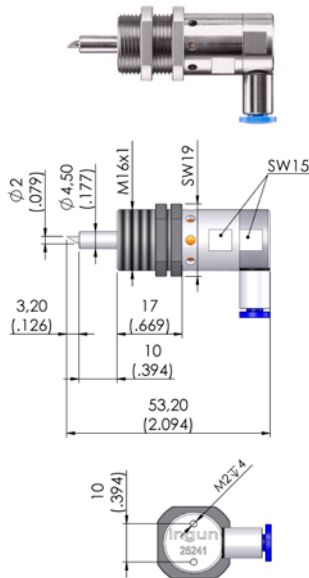

### ME-P-F1,0-16-054-QS4

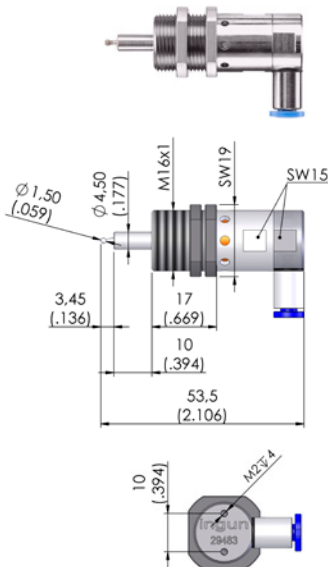

## Function

Compressed air causes the marking engraver to move with rotational motion. At the same time, a stroke movement is completed, so that the marking engraver is pressed against the electronic unit, marking the DUT permanently thanks to the rotational motion. Once the compressed air is shut off, the internal spring moves the marking engraver back to its home position.

## Technical specifications

### ME-P-S2,0-16-054-QS4

- Outer dimensions (D × L): approx.  $\varnothing$  16 × 54 mm
- Weight: approx. 0.07 kg
- Drive connection: compressed air connection
- Marking head: cutting engraver
- Engraver material: solid carbide
- Engraver hardness: approx. 1,600 HV
- Marking: circle, approx.  $\varnothing$  2.0 mm
- Materials: hard and soft materials

### ME-P-F1,0-16-054-QS4

- Outer dimensions (D × L): approx.  $\varnothing$  16 × 54 mm
- Weight: approx. 0.07 kg
- Drive connection: compressed air connection
- Marking head: milling engraver
- Engraver material: stainless steel, diamond-coated
- Engraver hardness: approx. 80 HRC
- Marking: circular point, approx.  $> \varnothing$  1.0 mm
- Materials: hard and soft materials

## General characteristic data

- Outer thread: M16 × 1
- Lock nut : size 19
- Operating temperature range: - 30 °C to + 80 °C
- Recommended working stroke: approx. (+) 2.0 mm
- Maximum stroke: approx. (+) 3.5 mm
- Recommended marking impulse: approx. 0.5 s to 1.0 s
- Force at working stroke: approx. 2.0 N
- Spare part engraver kit: –
- RoHS (2011/65/EC): compliant
- CE (2006/42/EC): partly completed machinery

## Drive specifications

- Drive: Compressed air motor
- Operating pressure: 0.6 MPa
- Operating medium: filtered, not oiled, compressed air
- Compressed air connection: compressed air hose at QS4 push-in fitting with e.g. PUN-4x0,75-BL
- Permitted particle size:  $\leq 40 \mu\text{m}$
- Normal rated flow:  $\geq 100 \text{ l/min}$
- Idle speed: approx. 27,000 RPM
- Noise emission: high-frequency (approx. 90 dB @ 1 m)

## Pneumatic marking units (ME-P)

### Installation

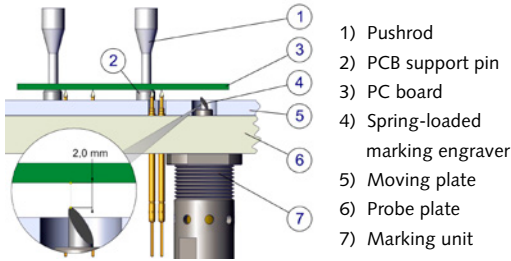

- 1) Pushrod
- 2) PCB support pin
- 3) PC board
- 4) Spring-loaded marking engraver
- 5) Moving plate
- 6) Probe plate
- 7) Marking unit

### Silencer

#### SD-SB-01-07-D16-15

– Reduction of noise emissions by approx. 7 dB

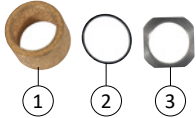

- 1) Sinter bushing
- 2) O-ring
- 3) Lock nut



– Assembly example

### Suction devices

#### ASV-ME-P-WK-EC

- Compatible with parts: 25241, 29483
- Outer dims. (W × D × H): approx. 120 × 37 × 80 mm
- Suction head (W × D): approx. 16 × 31 mm
- Operating pressure: 0.6 MPa

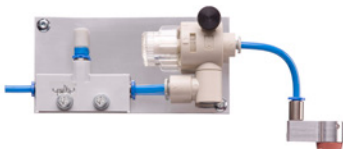

### Installation

When contacting the PCB, install the pneumatic marking units so that the marking engraver has about 2.0 mm of clearance from the marking surface and is oriented vertically to this surface. To ensure an uninterrupted air flow, the air vent holes must not be covered. Use the Ø 4.5 mm shaft of the M16 outer thread, or two M2 threaded holes on the housing cover to mount the marking unit on the probe plate (from below) or pressure frame plate (from above).

### Silencer

A silencer is offered for the pneumatic marking units. When using the silencer, the high-frequency noise emission with a compressed air feed of 0.6 MPa is reduced by approx. 7 dB. It may be necessary to readjust the recommended working stroke by approx. 0.2 to 0.3 mm.

### Suction devices

A suction device (ASV) is offered for extracting the shavings produced during the marking operation for the pneumatic marking units.

### Customisation example

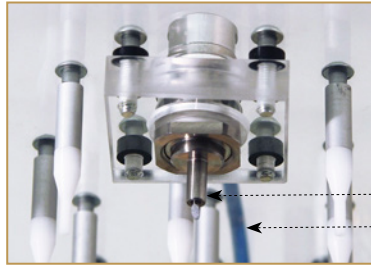

- Pneumatic marking unit (part 25241)
- Compressed air hose (part 26707)

Top contacting with pneumatic marking unit (ME-P)

### Note:

When operating the pneumatic marking units, a high-frequency noise of approx. 90 dB is emitted at a distance of 1 m.

### Note:

Compatible compressed air hoses (PUN) can be found on page 209.



### Spare part engraver kit:



A spare part engraver kit is not offered for the pneumatic marking units, due to the geometric alignment of the Compressed air motor to the marking engraver and the collinearity of the overall system.

## Ordering information

Pneumatic marking units (ME-P)			
Part no.:	25241	ME-P-S2,0-16-054-QS4	Cutting engraver, hard and soft materials
Part no.:	29483	ME-P-F1,0-16-054-QS4	Milling engraver, hard and soft materials
Accessories			
Part no.:	53904	SD-SB-01-07-D16-15	Silencer, sound level reduction by approx. 7 dB, at 0.6 MPa compressed air
Part no.:	36792	ASV-ME-P-WK-EC	Suction device suitable for parts 25241 and 29483
Part no.:	32680	MHE2-M1H-3/2G-QS-4-K	Magnet valve 3/2 closed, 24 V DC, normal rated flow 100 l/min



Type	Electrical marking unit (ME-E)	Electrical marking unit (ME-E)	Electrical marking unit (ME-E)
<b>Designation</b>	ME-E-R2,0-12-060-K12V	ME-E-S2,0-12-060-K12V	ME-E-R2,0-12-100-K12V
<b>Marking unit part number</b>	24447	25251	24456
<b>Outer dimensions (D × L)</b>	approx. Ø 12 × 60 mm	approx. Ø 12 × 60 mm	approx. Ø 12 × 100 mm
<b>Outer thread</b>	M12 × 1	M12 × 1	M12 × 1
<b>Lock nut</b>	Size 14	Size 14	Size 14
<b>Weight</b>	approx. 0.04 kg	approx. 0.04 kg	approx. 0.05 kg
<b>Operating temperature range</b>	- 20 °C to + 65 °C	- 20 °C to + 65 °C	- 20 °C to + 65 °C
<b>Drive connection</b>	Cable	Cable	Cable
<b>Recommended working stroke</b>	approx. (-) 1.5 mm	approx. (-) 1.5 mm	approx. (-) 1.5 mm
<b>Maximum stroke</b>	approx. (-) 2.0 mm	approx. (-) 2.0 mm	approx. (-) 2.0 mm
<b>Recommended marking impulse</b>	approx. 1.0 s	approx. 1.0 s	approx. 1.0 s
<b>Force at working stroke</b>	approx. 3.0 N	approx. 3.0 N	approx. 3.0 N
<b>Marking head</b>	Scratching engraver	Cutting engraver	Scratching engraver
<b>Engraver material</b>	Solid carbide	Solid carbide	Solid carbide
<b>Engraver hardness</b>	approx. 1,600 HV	approx. 1,600 HV	approx. 1,600 HV
<b>Marking</b>	 Circle, approx. Ø 2.0 mm	 Circle, approx. Ø 2.0 mm	 Circle, approx. Ø 2.0 mm
<b>Materials</b>	Hard and soft materials	Soft materials	Hard and soft materials
<b>Spare part engraver kit</b>	Part 27316	–	Part 27316
<b>Silencer</b>	–	–	–
<b>Suction device</b>	Part 36797	Part 36797	Part 37021
<b>RoHS (2011/65/EC)</b>	Compliant	Compliant	Compliant
<b>CE (2006/42/EC)</b>	Partly completed machinery	Partly completed machinery	Partly completed machinery
<b>Drive (*)</b>	Electric gear motor	Electric gear motor	Electric gear motor
<b>Rated voltage (**) / operating pressure</b>	12 V DC	12 V DC	12 V DC
<b>Rated output / operating medium</b>	0.75 W	0.75 W	0.75 W
<b>No-load current / compressed air connection</b>	3.68 mA	3.68 mA	3.68 mA
<b>Starting current / permitted particle size</b>	106 mA	106 mA	106 mA
<b>Connection resistance / normal rated flow</b>	114 Ω	114 Ω	114 Ω
<b>Maximum constant load current</b>	81 mA	81 mA	81 mA
<b>Maximum torque</b>	54 mNm	54 mNm	54 mNm
<b>Idle speed</b>	approx. 180 RPM	approx. 180 RPM	approx. 180 RPM
<b>Noise emission</b>	Not relevant	Not relevant	Not relevant

Electrical marking unit (ME-E)	Pneumatic marking unit (ME-P)	Pneumatic marking unit (ME-P)
ME-E-R2,0-12-080-S12V	ME-P-S2,0-16-054-QS4	ME-P-F1,0-16-054-QS4
38371	25241	29483
approx. $\varnothing$ 12 x 80 mm	approx. $\varnothing$ 16 x 54 mm	approx. $\varnothing$ 16 x 54 mm
M12 x 1	M16 x 1	M16 x 1
Size 14	Size 19	Size 19
approx. 0.05 kg	approx. 0.07 kg	approx. 0.07 kg
- 20 °C to + 65 °C	- 30 °C to + 80 °C	- 30 °C to + 80 °C
Plug connector part 43637	Compressed air connection	Compressed air connection
approx. (-) 1.5 mm	approx. (+) 2.0 mm	approx. (+) 2.0 mm
approx. (-) 2.0 mm	approx. (+) 3.5 mm	approx. (+) 3.5 mm
approx. 1.0 s	approx. 0.5 s to 1.0 s	approx. 0.5 s to 1.0 s
approx. 3.0 N	approx. 2.0 N	approx. 2.0 N
Scratching engraver	Cutting engraver	Milling engraver
Solid carbide	Solid carbide	Stainless steel, diamond-coated
approx. 1,600 HV	approx. 1,600 HV	approx. 80 HRC
 Circle, approx. $\varnothing$ 2.0 mm	 Circle, approx. $\varnothing$ 2.0 mm	 Circular point, approx. $> \varnothing$ 1.0 mm
Hard and soft materials	Hard and soft materials	Hard and soft materials
Part 27316	–	–
–	Part 53904	Part 53904
Part 36797	Part 36792	Part 36792
Compliant	Compliant	Compliant
Partly completed machinery	Partly completed machinery	Partly completed machinery
Electric gear motor	Compressed air motor	Compressed air motor
12 V DC	0.6 MPa	0.6 MPa
0.75 W	Filtered, not oiled, compressed air	Filtered, not oiled, compressed air
3.68 mA	Compressed air hose at QS4 socket	Compressed air hose at QS4 socket
106 mA	$\leq$ 40 $\mu$ m	$\leq$ 40 $\mu$ m
114 $\Omega$	$\geq$ 100 l/min	$\geq$ 100 l/min
81 mA	–	–
54 mNm	–	–
approx. 180 RPM	approx. 27,000 RPM	approx. 27,000 RPM
Not relevant	High-frequency (approx. 90 dB @ 1 m)	High-frequency (approx. 90 dB @ 1 m)

## INGUN marking units – most attractive overall package

- The best marking results on the market
- Maximum abrasion resistance
- Optimal positioning
- The widest product variety

In a product benchmark from January 2016, the quality and performance characteristics of three well-established marking units on the market were evaluated in a systematic product analysis and compared.

Alongside the mechanical and electrical life span, the quality of the design, delivery, and costs were also considered.

The results were graded using a scale from 1 (very good) to 6 (inadequate) and summarised in a diagram showing the various strengths and weaknesses.

Mechanical/ electrical life span	Markings		Marking head after 800,000 engravings
	after 225,000 engravings	after 675,000 engravings	
INGUN			
Competitor A			
Competitor B			

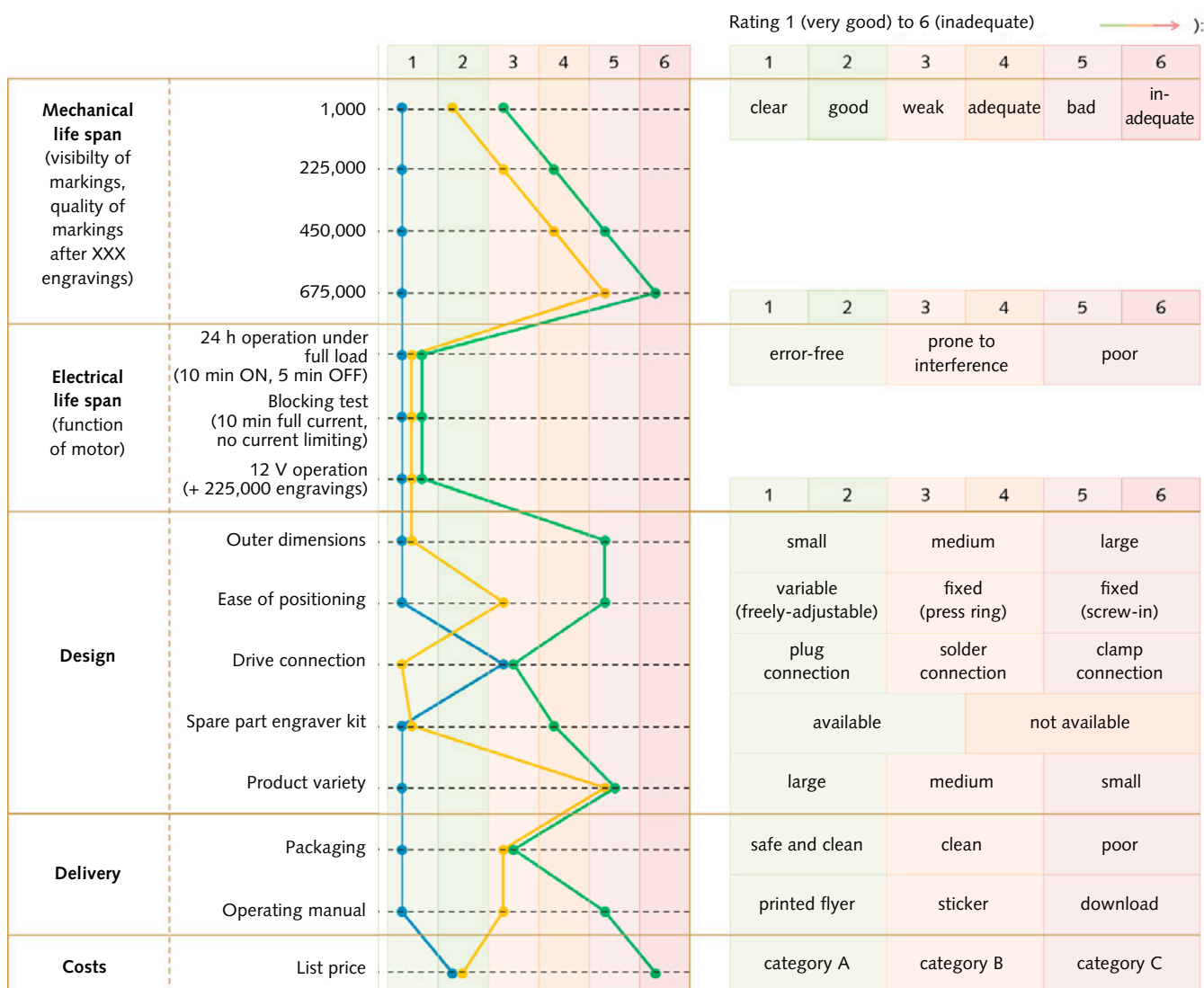

- **INGUN**
- **Competitor A**
- **Competitor B**

# Side approach mechanisms

## Precise lateral contacting with compact units

### Stroke-controlled side approach mechanisms (SAM-H)



SAM-H7-16-150N-020-060-S

### Manual side approach mechanisms (SAM-M)



SAM-M-20-150N-070-063



SAM-M-14-300N-202-145



SAM-M-14-300N-268-145

### Pneumatic side approach mechanisms (SAM-P)



SAM-P-50-068N-082-105

#### Usage

Side approach mechanisms (SAM) are provided for the reliable contacting of electronic components onto the electronic units to be tested, for which a lateral contact stroke in the form of a horizontally directed stroke movement is required. The contact stroke can be generated in three different ways: stroke controlled (SAM-H), manually (SAM-M) or pneumatically (SAM-P).

#### Determinant features

- Compact, robust design
- Stable, maintenance-free precision guidance
- Space-saving, simple, precise mounting
- Stroke controlled, manual or pneumatic activation
- Outstanding life span

#### Life span

- 300,000 load cycles (laboratory conditions)  
The life span is determined in the laboratory with fully automatic, computer-controlled endurance test stations under full load. Since the life span depends on many different factors and in particular on the individual test application, INGUN cannot guarantee the actual duration of use in the test field.

#### Control/functional elements

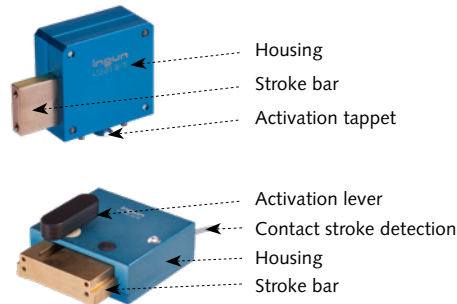

(stroke bar is shown extended)

### Stroke-controlled side approach mechanisms (SAM-H)

SAM-H7-16-150N-020-060-S 180

#### Accessories for SAM-H

Spring mounting block 180

### Manual side approach mechanisms (SAM-M)

SAM-M-20-150N-070-063 181

SAM-M-14-300N-202-145 182

SAM-M-14-300N-268-145 182

#### Accessories for SAM-M

Contact stroke detection (set) 181

### Pneumatic side approach mechanisms (SAM-P)

SAM-P-50-068N-082-105 183

#### Accessories for SAM-P

Proximity switch 183  
Valve assembly (set) 183

#### Note

For overview and comparison table see page 184.

## Stroke-controlled side approach mechanisms (SAM-H)

SAM-H7-16-150N-020-060-S

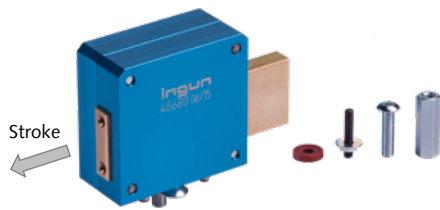

### Permitted load

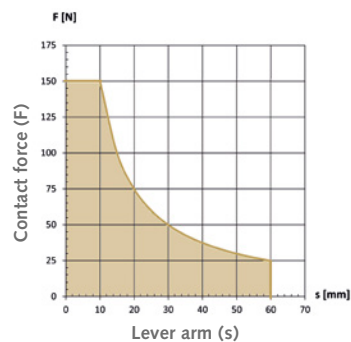

### Function

1. Contacting pressing forwards

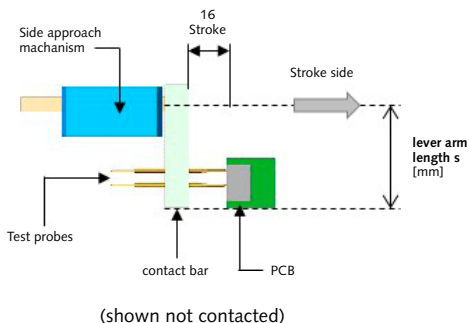

2. Contacting pressing backwards

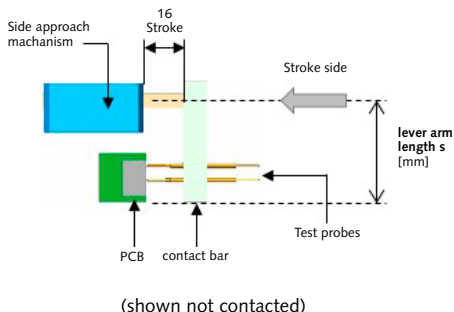

### Function

Activation is stroke-controlled, and involves converting the vertical stroke movement of the test fixture (operating stroke) into a horizontal stroke movement of the stroke bar on the side approach mechanism (contact stroke).

The contact stroke is designed to be a maximum of 16 mm with an operating stroke of 7 mm from the test fixture. The stroke controlled side approach mechanism is suitable for use in vacuum test fixtures.

### Additional features

- Suitable for use in vacuum test fixtures

### Technical specifications

SAM-H7-16-150N-020-060-S

- Series: SAM-H
- Maximum contact force: 150 N (with centre load)
- Maximum contact stroke: 16 mm
- Contact stroke generation: stroke controlled
- Maximum operating stroke: 7 mm
- Maximum lever arm length (s): 60 mm
- Torque: 1.5 Nm
- Operating temperature range: - 5 °C to + 60 °C
- Outer dimensions (W × D × H): approx. 20 × 60 × 40 mm
- Weight: approx. 0.14 kg

### Customisation example

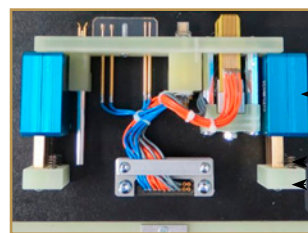

- Stroke controlled side approach mechanism (part 45680)
- Pressure spring (part 19994)
- Spring mounting block (part 54092)

Side contacting with stroke controlled side approach mechanisms (SAM-H)

## Ordering information

Stroke-controlled side approach mechanisms (SAM-H)		
Part no.: 45680	SAM-H7-16-150N-020-060-S	Contact force 150 N, contact stroke 16 mm
Accessories		
Part no.: 54092	Spring mounting block	Mounting block for mounting up to 4 pressure springs (part 19994)



## Manual side approach mechanisms (SAM-M)

### SAM-M-20-150N-070-063



### Permitted load

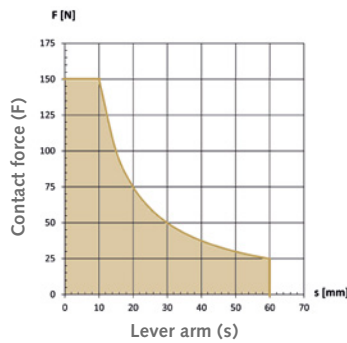

### Function

#### Contacting pressing forwards

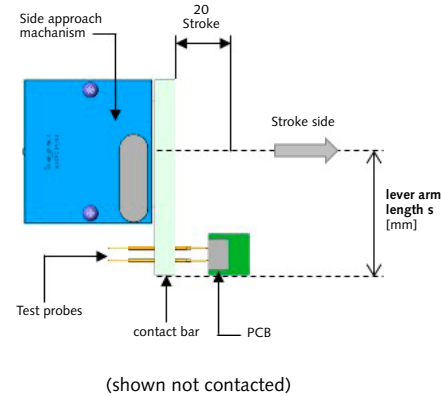

### Function

Activation is manual, and is achieved by turning the activation lever approximately 90° in a clockwise direction. The stop position of the stroke mechanism is detected using an optionally available proximity switch. After activation, the stroke mechanism remains stable in the end position.

### Technical specifications

#### SAM-M-20-150N-070-063

- Series: SAM-M
- Maximum contact force: 150 N (with centre load)
- Maximum contact stroke: 20 mm
- Contact stroke generation: manual
- Contact stroke detection: proximity switch (optionally available)
- Maximum lever arm length (s): 60 mm
- Torque: 1.5 Nm
- Operating temperature range: - 5 °C to + 60 °C
- Outer dimensions (W × D × H): approx. 70 × 63 × 40 mm
- Weight: approx. 0.41 kg

#### Contact stroke detection (set)

##### Proximity switch SME-8-K-LED-24

- Measurement principle: magnetised reed
- Switching element function: NO contact
- Rated operating voltage: 12 to 30 V (DC and AC)
- Maximum output current: 500 mA
- Electrical connection: cable (3-core)
- Delivery includes:
  - Proximity switch SME-8-K-LED-24 (cable length approx. 2.5 m)
  - Ring magnet D6×2
  - Countersunk screw M2.5×6

### Customisation example

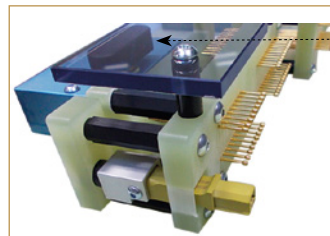

Manual side approach mechanism (part 41070)

Side contacting with manual side approach mechanism (SAM-M)

### Contact stroke detection (set)

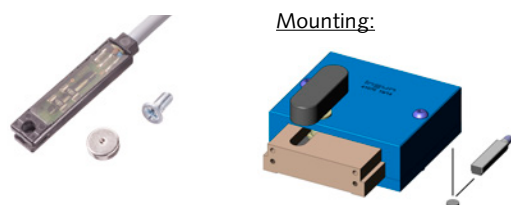

## Ordering information

Manual side approach mechanisms (SAM-M)		
Part no.: 41070	SAM-M-20-150N-070-063	Contact force 150 N, contact stroke 20 mm
Accessories		
Part no.: 45790	Contact stroke detection (set)	Includes proximity switch, ring magnet, mounting screw

## Manual side approach mechanisms (SAM-M)

### SAM-M-14-300N-202-145

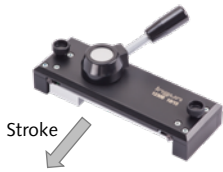

- Quick-exchange
- Mounting of multi-point connector possible

### SAM-M-14-300N-268-145

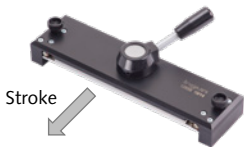

- Quick-exchange
- Mounting of two multipoint connectors possible

## Permitted load

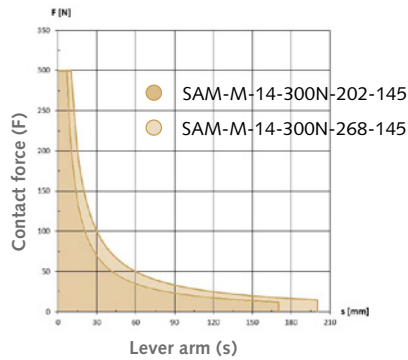

## Function

Contacting pressing forwards

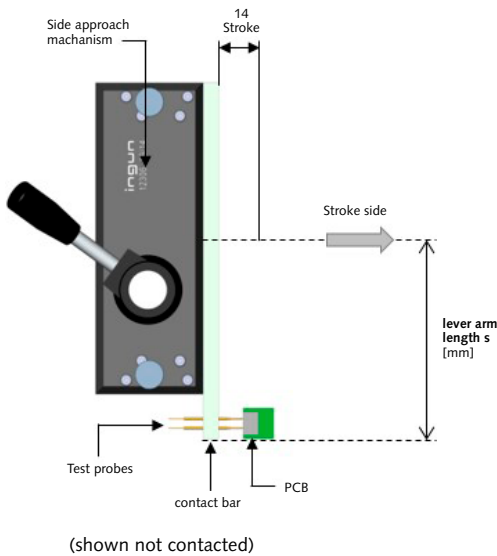

## Function

Activation is manual, and is achieved by turning the activation lever approx. 90° in a clockwise direction. The end position of the stroke mechanism is detected using a micro switch (NO - normally open) that is included in the scope of delivery. After activation, the stroke mechanism remains stable in the end position.

## Additional features

- Quick-exchange using two knurled-head screws
- Mounting of multipoint connectors (DIN 41612/IEC 60603-2) possible

## Technical specifications

### SAM-M-14-300N-202-145

- Maximum lever arm length (s): 170 mm
- Torque: 2.1 Nm
- Outer dimensions (W × D × H): approx. 202 × 145 × 85 mm
- Weight: approx. 0.78 kg

### SAM-M-14-300N-268-145

- Maximum lever arm length (s): 200 mm
- Torque: 3.0 Nm
- Outer dimensions (W × D × H): approx. 268 × 145 × 85 mm
- Weight: approx. 0.85 kg

## General characteristic data

- Series: SAM-M
- Maximum contact force: 300 N (with centre load)
- Maximum contact stroke: 14 mm
- Contact stroke generation: manual
- Contact stroke detection: micro switch (NO - normally open)
- Operating temperature range: - 5 °C to + 60 °C

## Customisation example

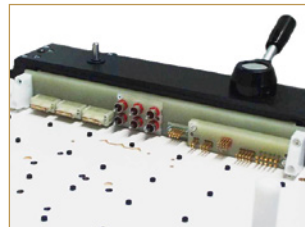

Manual side approach mechanism (part 12559)

Side contacting with manual side approach mechanism (SAM-M)

## Ordering information

Manual side approach mechanisms (SAM-M)		
Part no.: 12306	SAM-M-14-300N-202-145	Contact force 300 N, contact stroke 14 mm
Part no.: 12559	SAM-M-14-300N-268-145	Contact force 300 N, contact stroke 14 mm

## Pneumatic side approach mechanisms (SAM-P)

### SAM-P-50-068N-082-105

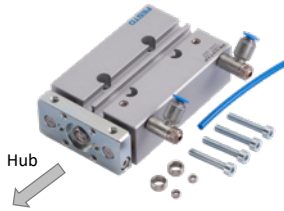

### Permitted load

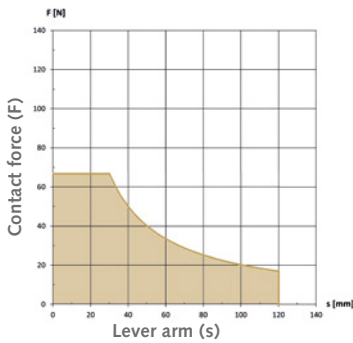

### Function

Contacting pressing forwards

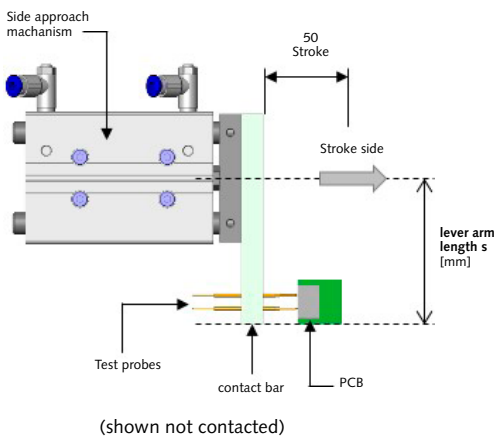

### Proximity switch

Mounting:

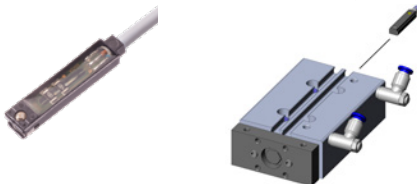

### Function

Activation is achieved pneumatically by feeding compressed air to the stroke cylinder. The end position of the stroke mechanism is detected using an optionally available proximity switch. After compressed air is switched off, the side approach mechanism moves back to its home position.

### Additional features

- Partly completed machinery in accordance with 2006/42/EC

### Technical specifications

#### SAM-P-50-068N-082-105

- Series: SAM-P
- Maximum contact force: 68 N (with centre load)
- Maximum contact stroke: 50 mm
- Contact stroke generation: pneumatic
- Contact stroke detection: proximity switch (optionally available)
- Maximum lever arm length (s): 120 mm
- Torque: 2.0 Nm
- Operating pressure: 0.6 MPa
- Compressed air connection: QS4
- Operating temperature range: - 5 °C to + 60 °C
- Outer dimensions (W × D × H): approx. 82 × 105 × 28 mm
- Weight: approx. 0.58 kg

#### Proximity switch SME-8-K-LED-24

- See page 181

#### Valve assembly (set)

- Valve function: 5/2 monostable
- Operating pressure: 0.1 to 1 MPa
- Pneumatic connection: M5
- Rated operating voltage: 24 V DC
- Display: LED
- Delivery includes:
  - Magnet valve 5/2-24 V DC
  - Power outlet cable
  - Push-in fitting
  - Silencer
  - Compressed air hose PUN-4x0,75-BL (length approx. 1 m)

### Customisation example

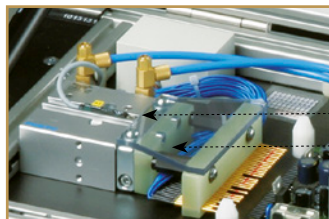

- ..... Proximity switch (part 25638)
- ..... Pneumatic side approach mechanism (part 50140)

Side contacting with pneumatic side approach mechanism (SAM-P)

## Ordering information

Pneumatic side approach mechanisms (SAM-P)		
Part no.: 50140	SAM-P-50-068N-082-105	Contact force 68 N, contact stroke 50 mm
Accessories		
Part no.: 25638	proximity switch	SME-8-K-LED-24
Part no.: 42702	Valve assembly (set)	Includes magnet valve, power outlet cable, push-in fitting, silencer

Type	Stroke-controlled side approach mechanism	Manual side approach mechanism	Manual side approach mechanism	Manual side approach mechanism	Pneumatic side approach mechanism
<b>Product group</b>	SAM	SAM	SAM	SAM	SAM
<b>Series</b>	SAM-H	SAM-M	SAM-M	SAM-M	SAM-P
<b>Designation</b>	SAM-H7-16-150N-020-060-S	SAM-M-20-150N-070-063	SAM-M-14-300N-202-145	SAM-M-14-300N-268-145	SAM-P-50-068N-082-105
<b>SAM part number</b>	45680	41070	12306	12559	50140
<b>Maximum contact force (with centre load)</b>	150 N	150 N	300 N	300 N	68 N
<b>Maximum contact stroke</b>	16 mm	20 mm	14 mm	14 mm	50 mm
<b>Contact stroke generation</b>	Stroke controlled	Manual	Manual	Manual	Pneumatic
<b>Contact stroke detection</b>	–	Proximity switch (*)	Micro switch (NO - normally open)	Micro switch (NO - normally open)	Proximity switch (*)
<b>Maximum operating stroke</b>	7 mm	–	–	–	–
<b>Maximum lever arm length (s)</b>	60 mm	60 mm	170 mm	200 mm	120 mm
<b>Torque</b>	1.5 Nm	1.5 Nm	2.1 Nm	3.0 Nm	2.0 Nm
<b>Operating pressure</b>	–	–	–	–	0.6 MPa
<b>Compressed air connection</b>	–	–	–	–	QS4
<b>Operating temperature range</b>	- 5 °C to + 60 °C	- 5 °C to + 60 °C	- 5 °C to + 60 °C	- 5 °C to + 60 °C	- 5 °C to + 60 °C
<b>Outer dimensions (W × D × H mm)</b>	20 × 60 × 40	70 × 63 × 40	202 × 145 × 85	268 × 145 × 85	82 × 105 × 28
<b>Weight</b>	0.14 kg	0.41 kg	0.78 kg	0.85 kg	0.58 kg
<b>Recommended accessories</b>	– Spring mounting block Part 54092	– Contact stroke detection (set) Part 45790	–	–	– Proximity switch Part 25638 – Valve assembly (set) Part 42702
<b>CE conformity (2006/42/EC)</b>	–	–	–	–	Partly completed machinery
<b>Special features</b>	– Suitable for use in vacuum test fixtures	–	– Quick-exchange using two knurled-head screws – Mounting of multipoint connectors (DIN 41612/IEC 60603-2) possible	–	–

\* Not included in scope of delivery

# Connectors and test plugs for reliable, low-wear contacting



**Usage**

Connectors (STK) and test plugs (PS) are used for the reliable, low-wear contacting of plug connectors on electronic units such as printed circuit boards (PCBs). Connectors differ from test plugs in that connectors include a test plug and an integrated floating mount for mounting. Connectors and test plugs are available in numerous designs for various applications and are grouped as follows:

**Connectors**

- **STK-X,XX**  
Connectors (STK-X,XX) with floating mount are used for precise, self-centring contacting of SMC (Small Multiple Connector) plug connectors.
- **STK-USB**  
Connectors (STK-USB) with floating mount are used for precise, low-wear contacting of digital USB high-speed plug connectors.

**Test plugs**

- **PS-RJ**  
Test plugs (PS-RJ) are used for precise, low wear contacting of digital network and phone plug connectors.
- **PS**  
Test plugs (PS) are used for precise, low-wear contacting of plug connectors to be tested when a purely electrical continuity check is required. Transmission of data rates is possible, although only by using specific methods, such as the use of a connection board with additional electronics. These methods are usually implemented by our customers themselves.

**Connectors (STK)**

STK-X,XX	186
STK-USB	187

**Test plugs**

PS-RJ	188
PS	189



## Connectors (STK)

Design: **STK-X,XX**

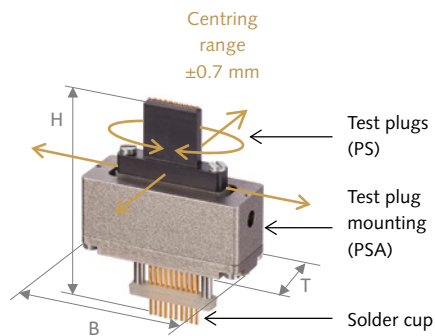

Connector (STK-X,XX)  
STK-1,00-M-010-JST  
(part 49911)



Connector (STK-X,XX)  
STK-1,27-M-020-Samtec  
(part 50005 – view from above)

## Design

The connectors (STK-X,XX) have a modular design consisting of a test plug (PS) adapted to the testing requirement and test plug mounting (PSA) for a floating mount. The connectors have 2 translational degrees and 1 rotational degree of freedom. This enables optimal alignment to the plug connector. Loading tolerances are balanced out, and lateral loads due to alignment errors are avoided during the contacting process.

## Features

- Floating mount
- Precise, low-wear, self-centring contacting
- Modular design
- Outstanding life span

## Customisation example

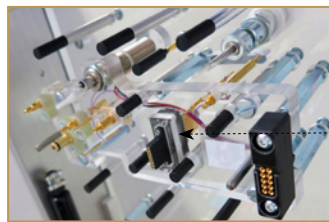

Connector (part 50005)

Top contacting with  
connector (STK-X,XX)

## Ordering information

Connectors (STK-X,XX) for SMC plug connectors								
Part no.	Designation	Compatible plug connector	Dimensions [mm]			Centring range [mm]	Connection	
			W	D	H			
49911	STK-1,00-M-010-JST	JST SH BM10B-SRSS-TB(LF)(SN)	30	12	41	± 0.7	Solder cup	
49990	STK-1,27-M-020-Erni	ERNI SMC-254588	30	12	49	± 0.7	Solder cup	
49996	STK-1,27-M-040-Erni	ERNI SMC-254590	47	13	49	± 0.7	Solder cup	
50005	STK-1,27-M-020-Samtec	SAMTEC Tiger Eye™ TFM-110-02-S-D-LC	30	12	49	± 0.7	Solder cup	
50010	STK-1,27-F-016-G-TE	TE Micro-Match 1-215079-6	42	13	52	± 0.7	Solder cup	
57899	STK-1,50-M-006-V30-TE	TE EMIX CONN. 1775444-6	25	12	53	± 0.7	Wired	
50004	STK-2,00-F-020-G-Molex	MOLEX Milli Grid™ 79109-8659	42	13	52	± 0.7	Solder cup	

Other connectors (STK-X,XX) with floating mount are available on request.

Series: STK  
Design: STK-USB

Contacting: Digital USB high-speed plug connector

## Connectors (STK)

Design: **STK-USB**

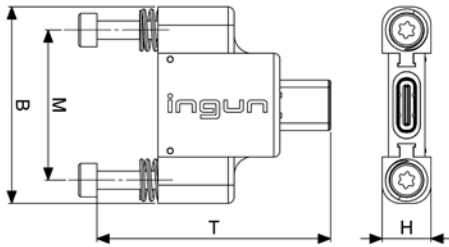

### Function

The connectors (STK-USB) consist of a test plug with integrated test plug mounting for a floating mount. This enables optimal alignment to the plug connector. Loading tolerances are balanced out, and lateral loads due to alignment errors are avoided during the contacting process. USB 3.0 connectors can also be used for the reliable contacting of USB 2.0 plug connectors.

### Features

- Precise, low-wear contacting
- Reliable data transmission
- Floating mounting
- Stackable for contacting dual or multiple sockets
- Easy connection with standard USB plug connectors
- USB 3.0 connectors also suitable for contacting USB 2.0 plug connectors
- Outstanding life span

**STK-USB3-A-009-S** (USB 3.0-A)

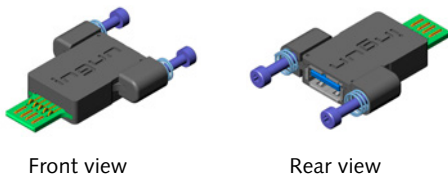

**STK-USB3.1-C-024-01** (USB 3.1-C)

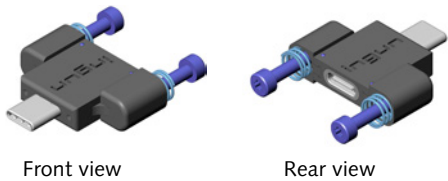

### Customisation example

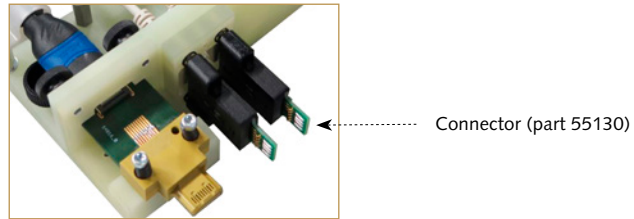

Side contacting with Connectors (STK-USB)

## Ordering information

Connectors (STK-USB) for digital USB high-speed plug connectors													
Part no.	Type/designation	Poles	Gross data rate	Max. voltage	Max. current	R [mΩ]	Temperature range [°C]	Connection cycles (*)	Dimensions [mm]				Version
									W	D	H	M	
55130	USB 3.0-A STK-USB3-A-009-S	9	5 Gbit/s	25 V AC/ 60 V DC	1.5 A	< 50	- 20 to + 50	100,000	34.0	53.0	9.2	26.2	Stackable in grids ≥ 8.5 mm
53808	USB 3.1-C STK-USB3.1-C-024-01	24	≥ 5 Gbit/s (USB 3.1 ready)	25 V AC/ 60 V DC	3.0 A	< 50	- 40 to + 50	100,000	32.2	38.3	8.0	24.6	Stackable in grids ≥ 8.1 mm

\*Laboratory conditions

## Test plugs (PS)

Design: **PS-RJ**

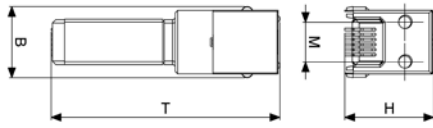

**PS-RJ12-M-006** (RJ12)



Front view



Rear view

**PS-RJ45-M-008** (RJ45)



Front view



Rear view

**PS-RJ45-M-008-XL** (RJ45, extended)



Front view

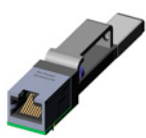

Rear view

– Incl. bridge for levelling, for multiple contacting together with PS-RJ45-M-008 grids  $\geq 14$  mm

## Test plug mounting (PSA)

**PSA-F16,5-RJxx**

**PSA-F16,5-RJxx-Twin**

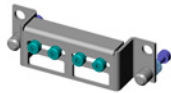

## Function

Test plugs (PS-RJ) can be used for the reliable transmission of gross data rates of 1 Gbit/s. Connection to the test plug is achieved by using an industry-standard RJ connector. The optionally available test plug mounting is used for the floating mounting of the test plugs.

## Features

- Precise, low-wear contacting
- Reliable data transmission
- Shielded design for earth contacting and shielding detection
- Easy connection with industry-standard RJ plug connectors
- Outstanding life span
- Test plug mounting for floating mounting available (optional)

## Customisation example

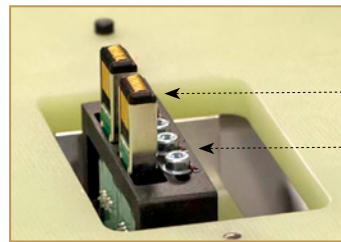

Test plug (part 55140)

Test plug mounting (part 55148)

Bottom contacting with test plugs (PS-RJ)

## Ordering information

Test plugs (PS-RJ) for digital phone and network plug connectors													
Part no.	Type/designation	Poles	Gross data rate	Max. voltage	Max. current	R [mΩ]	Temperature range [°C]	Connection cycles (*)	Dimensions [mm]				Connection
									W	D	H	M	
53767	RJ12 PS-RJ12-M-006	6	1 Gbit/s	25 V AC/ 60 V DC	1.5 A	< 180	- 40 to + 75	250,000	14.2	47.0	18.0	8.0	Phone plug connector
55140	RJ45 PS-RJ45-M-008	8	1 Gbit/s	600 V AC	1.5 A	< 180	- 40 to + 75	250,000	16.5	53.0	17.0	10.0	Network plug connector
102216	RJ45 (extended) PS-RJ45-M-008-XL	8	1 Gbit/s	25 V AC/ 60 V DC	1.5 A	< 180	- 40 to + 75	250,000	16.5	86.4	16.6 (18.6)	10.0 (6.0)	Network plug connector

Test plug mounting (PSA)									
Part no.	Designation	Compatible RJ plug connector	Dimensions [mm]			Grid [mm]	Version	Delivery	
			W	D	H				
55146	PSA-F16,5-RJxx	PS-RJxx-M-00x(-x)	41.0	31.5	17.5	–	Contacting of individual plug connectors	Test plugs not included	
55148	PSA-F16,5-RJxx-Twin		70.0	31.5	19.5	16.5 to 28 (adjustable)	Contacting of dual plug connectors		











\*Laboratory conditions

### Usage

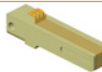
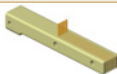
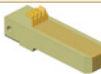
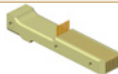

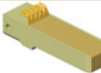
The test plugs (PS) are designed for a purely electrical continuity check. Transmission of data rates is possible, although only by using specific methods, such as the use of a connection board with additional electronics. These methods are usually implemented by our customers themselves.

## Ordering information

### Test plugs (PS) for electrical continuity checking

<b>USB, type A</b>  Designation: PS-USB-A-004-F9,6 Part no.: <b>21071</b> Number of poles: 4 Max. voltage: 25 V AC/60 V DC Max. connection cycles: 100,000 Mounting: PSA-F9,6	<b>USB, type B</b>  Designation: PS-USB-B-004-F9,6 Part no.: <b>17829</b> Number of poles: 4 Max. voltage: 25 V AC/60 V DC Max. connection cycles: 100,000 Mounting: PSA-F9,6	<b>USB mini, type B</b>  Designation: PS-USB-Mini-B-005-F7,6 Part no.: <b>21072</b> Number of poles: 5 Max. voltage: 25 V AC/60 V DC Wire resistance: < 20 mΩ Max. connection cycles: 70,000 Mounting: PSA-F7,6
<b>USB micro, type B</b>  Designation: PS-USB-Micro-B-005-F7,6 Part no.: <b>34816</b> Number of poles: 5 Max. voltage: 25 V AC/60 V DC Max. connection cycles: 50,000 Mounting: PSA-F7,6	<b>RJ10</b>  Designation: PS-RJ-10-004-F7,6 Part no.: <b>17824</b> Number of poles: 4 Max. voltage: 25 V AC/60 V DC Max. connection cycles: 200,000 Mounting: PSA-F7,6	<b>RJ12</b>  Designation: PS-RJ-12-006-F9,6 Part no.: <b>17825</b> Number of poles: 6 Max. voltage: 25 V AC/60 V DC Max. connection cycles: 200,000 Mounting: PSA-F9,6
<b>RJ12, extended (L = 58 mm)</b>  Designation: PS-RJ-12-006-F9,6-L Part no.: <b>35427</b> Number of poles: 6 Max. voltage: 25 V AC/60 V DC Max. connection cycles: 200,000 Mounting: PSA-F9,6	<b>RJ45</b>  Designation: PS-RJ-45-008-F11,6 Part no.: <b>17826</b> Number of poles: 8 Max. voltage: 25 V AC/60 V DC Max. connection cycles: 200,000 Mounting: PSA-F11,6	<b>RJ45, extended (L = 58 mm)</b>  Designation: PS-RJ-45-008-F11,6-L Part no.: <b>35428</b> Number of poles: 8 Max. voltage: 25 V AC/60 V DC Max. connection cycles: 200,000 Mounting: PSA-F11,6
<b>RJ45 with shielding query</b>  Designation: PS-RJ-45-008-F11,6-S Part no.: <b>41164</b> Number of poles: 8 Max. voltage: 25 V AC/60 V DC Max. connection cycles: 200,000 Mounting: PSA-F11,6	<b>RJ50</b>  Designation: PS-RJ-50-010-F11,6 Part no.: <b>17827</b> Number of poles: 10 Max. voltage: 25 V AC/60 V DC Max. connection cycles: 200,000 Mounting: PSA-F11,6	<b>HDMI</b>  Designation: PS-HDMI-019 Part no.: <b>34814</b> Number of poles: 19 Max. voltage: 25 V AC/60 V DC Max. connection cycles: 100,000 Mounting: –
<b>TAE</b>  Designation: PS-TAE-006 Part no.: <b>34847</b> Number of poles: 6 Max. voltage: 25 V AC/60 V DC Max. connection cycles: – Mounting: –	<b>Power DC, Ø 2.1</b>  Designation: PS-PowerDC-D2,1 Part no.: <b>35640</b> Number of poles: 2 Max. voltage: 12 V Max. connection cycles: – Mounting: –	

### Test plug mountings (PSA)

 Designation: PSA-F7,6 Part no.: <b>17830</b>	 Designation: PSA-F9,6 Part no.: <b>18198</b>	 Designation: PSA-F11,6 Part no.: <b>18199</b>
--	--	---

## Screwing units (SBE)

Activation: Manual

Design: **Standard**

### SBE-M-08-S4



- Stroke: adjustable up to 35 mm
- Mounting grid: 8 mm
- Activation: manual
- Slotted bit
- Rotary knob: PVC (white)

### SBE-M-15-S4



- Stroke: adjustable up to 35 mm
- Mounting grid: 15 mm
- Activation: manual
- Slotted bit
- Rotary knob: Aluminium with zero marking



### SBE-M-15-6,2IW4,8



- Stroke: adjustable up to 35 mm
- Mounting grid: 15 mm
- Activation: manual
- Round bit, designed with  $\varnothing$  6.2 mm hole and inner width of 4.8 mm
- Rotary knob: aluminium with zero marking



Design: **Airtight**

### SBE-M-18-11-S3-VD



- Stroke: 11 mm
- Mounting grid: 18 mm
- Activation: manual
- Slotted and cross slot bit
- Rotary knob: POM (white)

## Usage

With screwing units (SBE), space-saving alignment of adjustable screw-in devices can be performed during testing. Activation is performed manually.

## Features

- Simple, quick, space-saving mounting
- Standard and airtight designs
- Slotted, cross slot, or round bit with hole

## Technical specifications

### Screwing unit (SBE) design: Standard

- **SBE-M-08-S4:**
  - Stroke: adjustable up to 35 mm
  - Mounting grid: 8 mm
  - Total length: 105 mm
  - Slotted bit: mounted
  - Width: 4 mm
  - Depth: approx. 0.7 mm
  - Rotary knob: PVC (white) with  $\varnothing$  8 mm
- **SBE-M-15-S4:**
  - Stroke: adjustable up to 35 mm
  - Mounting grid: 15 mm
  - Total length: 102 mm
  - Slotted bit: mounted
  - Width: 4 mm
  - Depth: approx. 0.7 mm
  - Rotary knob: Aluminium  $\varnothing$  15 mm with zero marking

- **SBE-M-15-6,2IW4,8:**
  - Stroke: adjustable up to 35 mm
  - Mounting grid: 15 mm
  - Total length: 113 mm
  - Round bit: mounted
  - hole:  $\varnothing$  6.2 mm
  - Inner width: 4.8 mm
  - Outer diameter: 10 mm (height 20 mm)
  - Rotary knob: aluminium  $\varnothing$  15 mm with zero marking

### Screwing unit (SBE) design: airtight

- **SBE-M-18-11-S3-VD:**
  - Stroke: 11 mm
  - Mounting grid: 18 mm
  - Total length: 97 mm
  - Slotted bit: mounted
  - Width: 3 mm
  - Depth: approx. 0.7 mm
  - Cross slot bit: included, not mounted
  - Rotary knob: POM (white) with  $\varnothing$  18 mm
- **SBE-M-18-26-S3-VD:**
  - Stroke: 26 mm
  - Mounting grid: 8 mm
  - Total length: 127 mm
  - Slotted bit: mounted
  - Width: 3 mm
  - Depth: approx. 0.7 mm
  - Cross slot bit: included, not mounted (size: 1)
  - Rotary knob: POM (white) with  $\varnothing$  18 mm
- **SBE-M-18-11-6,2IW4,8-VD:**
  - Stroke: 11 mm
  - Mounting grid: 18 mm
  - Total length: 100 mm
  - Round bit: mounted
  - hole:  $\varnothing$  6.2 mm
  - Inner width: 4.8 mm
  - Outer diameter: 12 mm (height 17 mm)
  - Rotary knob: POM (white) with  $\varnothing$  18 mm



Screwing units (SBE)  
 Activation: Manual

Design: Airtight

**SBE-M-18-26-S3-VD**



- Stroke: 26 mm
- Mounting grid: 18 mm
- Activation: manual
- Slotted and cross slot bit
- Rotary knob: POM (white)

**SBE-M-18-11-6,2IW4,8-VD**



- Stroke: 11 mm
- Mounting grid: 18 mm
- Activation: manual
- Round bit, designed with  
 Ø 6.2 mm hole and  
 inner width of 4.8 mm
- Rotary knob: POM (white)

Customisation example

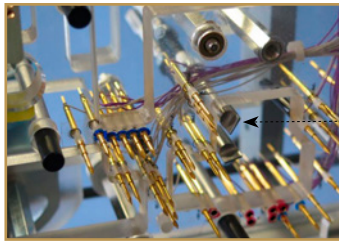

Screwing unit (part 19491)

Top contacting with  
 screwing unit (SBE)

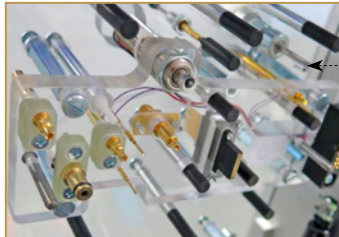

Screwing unit (part 17049)

Top contacting with  
 screwing unit (SBE)

Ordering information

Screwing unit (SBE) : Standard			
Part no.:	19491	SBE-M-08-S4	Manual screwing unit, total length 105 mm, slotted bit
Part no.:	40850	SBE-M-15-S4	Manual screwing unit, total length 102 mm, slotted bit
Part no.:	41694	SBE-M-15-6,2IW4,8	Manual screwing unit, total length 113 mm, round bit with Ø 6.2 mm borehole and inner width of 4.8 mm
Screwing unit (SBE) : Airtight			
Part no.:	17049	SBE-M-18-11-S3-VD	Manual screwing unit, total length 97 mm, slotted and cross slot
Part no.:	55465	SBE-M-18-26-S3-VD	Manual screwing unit, total length 127 mm, slotted and cross slot
Part no.:	40666	SBE-M-18-11-6,2IW4,8-VD	Manual screwing unit, total length 100 mm, round bit with Ø 6.2 mm borehole and inner width of 4.8 mm

**Screwing units (SBE)**  
 Activation: Step motor

Design: **Flexible shaft**

**SBE-O-08-04-S2,5-BW1,8**



- Stroke: 4 mm
- Mounting grid: 8 mm
- Activation: with optionally available step motor
- Slotted and cross slot bits

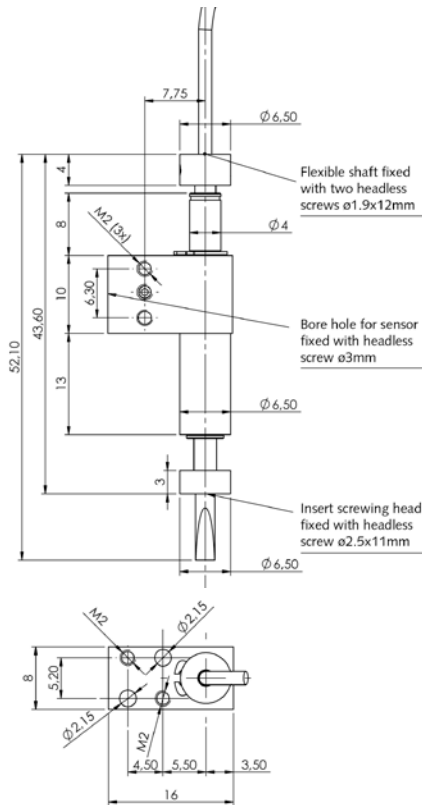

**Features**

- Simple, quick, space saving mounting
- Slotted and cross slot bits
- Floating mounted, spring-loaded bedded screwing head
- Operation via flexible (or rigid) shaft, electrically driven by optionally available step motor
- Space saving positioning, as required, of the drive during operation with flexible shaft
- Zero point position can be detected via optionally available sensor

**Technical specifications**

Screwing unit (SBE) design: flexible shaft

- **SBE-O-08-04-S2,5-BW1,8:**

- Stroke: 4 mm
- Mounting grid: 8 mm
- Total length: 52.1 mm
- Slotted bit: mounted
  - Width: 2.5 mm
  - Depth: approx. 0.5 mm
- Cross slot bits: included, not mounted (size: 00, 0, 1)
- Force at stroke: approx. 3.0 N
- Flexible shaft: included loose
  - Diameter: 1.8 mm
  - Length: approx. 1 m
  - Recommended direction of rotation: clockwise
  - Min. bending radius: approx. 35 mm

**Delivery includes**

Screwing unit without drive, with mounted slotted screwing head, cross slot screwing head included loose, flexible shaft, retaining ring 4x0.4 (DIN 471) and angled hexagon socket wrench, size 0.9.

**Customisation example**



- ..... Screwing unit (part 29292)
- ..... Flexible shaft
- ..... Step motor (part 28214)

Top contacting with screwing unit (SBE)

**Torsion angle with load torque (flexible shaft  $\phi$  1.8 mm)**

$\phi$ [mm]	Min. bending radius [mm]	Max. speed [RPM]	Torsion angle/ constant of torsion stiffness [°]		Ultimate load [Ncm]		Max. torque [Ncm]		Weight pro m [kg]
			RH rotation	LH rotation	RH rotation	LH rotation	RH rotation	LH rotation	
1.8	35	50000	550	2500	40	28	12	8	0.015

**Ordering information**

Screwing unit (SBE) : flexible shaft		
Part no.:	29292	SBE-O-08-04-S2,5-BW1,8
Screwing unit without drive, total length 52.1 mm, slotted and cross slot bits		
Accessories		
Part no.:	28214	Step motor
PANdrive 0.27 Nm with control unit (PD1-110-42-232)		
Part no.:	27780	Sleeve coupling
Flexible shaft to step motor, diameter 2.0 mm to 5.1 mm		
Part no.:	25263	Sensor
EM-030, type NPN, D = 3.0 mm, measuring distance 0.6 mm		
Part no.:	42261	Sensor (RoHS compliant)
EM-030, type NPN, D = 3.0 mm, measuring distance 0.6 mm (lead time approximately 6 – 8 weeks)		

## Button activators (TAB)

### TAB-M-10-5



- Stroke: 8 mm
- Mounting grid: 10 mm
- Tip style diameter: 5 mm
- Activation: manual

### TAB-M-10-6



- Stroke: 8 mm
- Mounting grid: 10 mm
- Tip style diameter: 6 mm
- Activation: manual

### TAB-M-10-6



- Stroke: 8 mm
- Mounting grid: 10 mm
- Tip style diameter: 6 mm
- Activation: manual

### TAB-M-12-5-NSRL



- Version: low voltage-compliant
- Stroke: 8 mm
- Mounting grid: 12 mm
- Tip style diameter: 5 mm
- Activation: manual

## Usage

Button activators (TAB) can be used for the space saving activation of buttons and spring-loaded switches during testing. Activation is performed manually.

## Features

- Simple, quick, space saving mounting
- Continuously adjustable via mounting hole

## Technical specifications

### Button activators

- **TAB-M-10-5:**
  - Stroke: 8 mm
  - Mounting grid: 10 mm
  - Tip style diameter: 5 mm
  - Width: 9.5 mm
  - Total length: 59 mm
  - Mounting hole: M5
- **TAB-M-10-6:**
  - Stroke: 8 mm
  - Mounting grid: 10 mm
  - Tip style diameter: 6 mm
  - Width: 9.5 mm
  - Total length: 77 mm
  - Mounting hole: M5
- **TAB-M-10-6:**
  - Stroke: 8 mm
  - Mounting grid: 10 mm
  - Tip style diameter: 6 mm
  - Width: 9.5 mm
  - Total length: 100 mm
  - Mounting hole: M5
- **TAB-M-12-5-NSRL:**
  - Design: low voltage-compliant
  - Stroke: 8 mm
  - Mounting grid: 12 mm
  - Tip style diameter: 5 mm
  - Width: 11.6 mm
  - Total length: 77 mm
  - Mounting hole: M6

## Customisation example



Button activator (part 25636)

Top contacting with button activator (TAB)

## Ordering information

Button activators (TAB)		
Part no.: 19637	TAB-M-10-5	Manual button activator, total length 59 mm
Part no.: 25636	TAB-M-10-6	Manual button activator, total length 77 mm
Part no.: 57584	TAB-M-10-6	Manual button activator, total length 100 mm
Part no.: 45692	TAB-M-12-5-NSRL	Manual button activator, total length 77 mm, low voltage-compliant

Series: NHS

Version: Rigid (two-part/one-part) | spring-loaded

Mounting: Screw in | plug in | press in

## Pushrod (NHS)

### Design: Rigid (two-part)

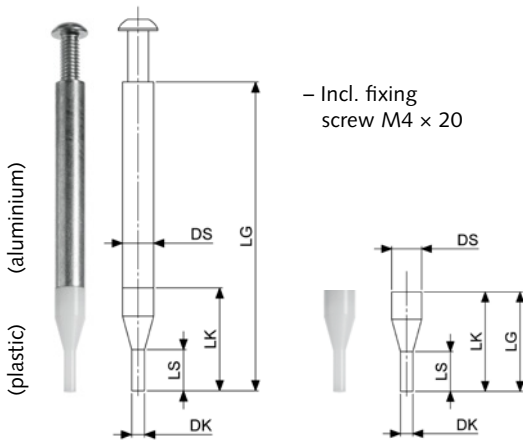

### Usage

Pushrods (NHS) are used in customisation in order to secure electronic printed circuit boards in the test fixture against the force of the test probes during contacting. Pushrods are mounted in the pressure frame plate.

### Features

- Simple, quick mounting
- Robust, pressure-resistant design
- Rigid and spring-loaded designs
- Various tip style diameters, various lengths
- Incl. fixing screw M4 x 20 (included loose) and/or receptacle KS-113 23

### Customisation example

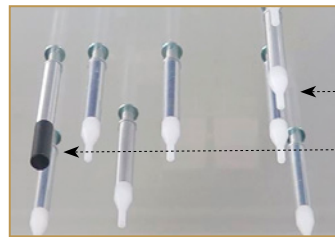

Pressure frame plate with pushrods (NHS)

### Design: Rigid (one-part)

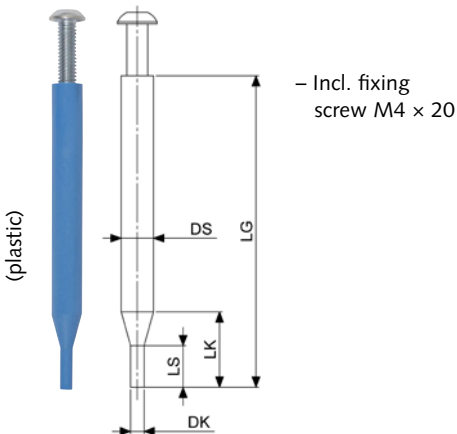

Top contacting with pushrods (NHS)

### Design: Spring-loaded

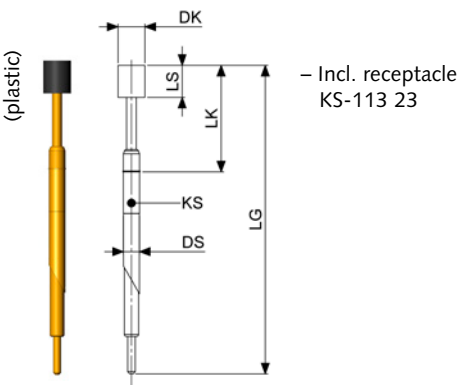

- LG = total length
- LK = head length
- LS = tip length
- DK = head diameter
- DS = shaft diameter

Series: NHS  
Version: Rigid (two-part/one-part) | spring-loaded  
Mounting: Screw in | plug in | press in

## Ordering information

Pushrod (NHS) : rigid (two-part)												
Part no.	Designation	Colour	Dimensions [mm]					Mounting	ESD R [Ω]	True running (DIN ISO)	Primarily used in	
			LG	LK	LS	DK	DS					
12681	NHS-ST-15,0-5,0-POM-D3	–	20.0	15.0	15.0	5.0	3.0	∅ 3.0 × 5 (P)	–	2768-fH	ZSK VA2xxx	
25856	NHS-ST-15,0-5,0-KU-ESD	–	20.0	15.0	15.0	5.0	3.0	∅ 3.0 × 5 (P)	< 10 <sup>5</sup>	2768-fH		
23057	NHS-ST-20,0-2,5-KU-D3-ESD	–	20.0	20.0	8.0	2.5	6.0	∅ 2.9 × 4 (H)	< 10 <sup>5</sup>	2768-fH	WS	
17340	NHS-ST-20,0-2,5-POM-D3	–	20.0	20.0	8.0	2.5	6.0	∅ 2.9 × 4 (H)	–	2768-fH		
22661	NHS-ST-20,0-2,5-POM-M3	–	20.0	20.0	8.0	2.5	6.0	M3 × 5.5 (T)	–	2768-fH	ATS MA 160	
19315	NHS-ST-20,0-4,0-KU-D3-ESD	–	20.0	20.0	8.0	4.0	6.0	∅ 2.9 × 4 (H)	< 10 <sup>5</sup>	2768-fH	WS	
18742	NHS-ST-20,0-6,0-PA-D3	–	20.0	20.0	20.0	6.0	6.0	∅ 2.9 × 4 (H)	–	2768-fH		
23503	NHS-ST-20,0-6,0-KU-D3-ESD	–	20.0	20.0	20.0	6.0	6.0	∅ 2.9 × 4 (H)	< 10 <sup>5</sup>	2768-fH		
23571	NHS-ST-28,0-2,5-POM-AL	Natural	28.0	20.0	8.0	2.5	6.0	M4 × 5 (T)	–	2768-mK	–	
28785	NHS-ST-34,0-2,5-POM-AL	Natural	34.0	20.0	8.0	2.5	6.0	M4 × 10 (T)	–	2768-mK	–	
17712	NHS-ST-36,4-2,5-POM-AL	Natural	36.4	20.0	8.0	2.5	6.0	M4 × 10 (T)	–	2768-mK	ATS PAZxxx	
17714	NHS-ST-41,0-2,5-POM-AL	Natural	41.0	20.0	8.0	2.5	6.0	M4 × 10 (T)	–	2768-mK	–	
26927	NHS-ST-50,0-2,5-POM-AL	Natural	50.0	20.0	8.0	2.5	6.0	M4 × 10 (T)	–	2768-mK	–	
19813	NHS-ST-51,0-2,5-POM-AL	Natural	51.0	20.0	8.0	2.5	6.0	M4 × 10 (T)	–	2768-mK	ATS PAxxxx	
19815	NHS-ST-51,0-6,0-PA-AL	Natural	51.0	20.0	20.0	6.0	6.0	M4 × 10 (T)	–	2768-mK		
17326	NHS-ST-55,0-2,5-POM-AL	Gold	55.0	20.0	8.0	2.5	6.0	M4 × 10 (T)	–	2768-mK	–	
17325	NHS-ST-55,3-2,5-POM-AL	Black	55.3	20.0	8.0	2.5	6.0	M4 × 10 (T)	–	2768-mK	–	
23504	NHS-ST-55,6-2,5-KU-AL-ESD	Green	55.6	20.0	8.0	2.5	6.0	M4 × 10 (T)	< 10 <sup>5</sup>	2768-mK	NDH/VKH (VA xxxx)	
17324	NHS-ST-55,6-2,5-POM-AL	Green	55.6	20.0	8.0	2.5	6.0	M4 × 10 (T)	–	2768-mK		
23342	NHS-ST-55,6-4,0-KU-AL-ESD	Green	55.6	20.0	8.0	4.0	6.0	M4 × 10 (T)	< 10 <sup>5</sup>	2768-mK		
23505	NHS-ST-55,6-6,0-KU-AL-ESD	Green	55.6	20.0	20.0	6.0	6.0	M4 × 10 (T)	< 10 <sup>5</sup>	2768-mK		
19419	NHS-ST-55,6-6,0-PA-AL	Green	55.6	20.0	20.0	6.0	6.0	M4 × 10 (T)	–	2768-mK	–	
43612	NHS-ST-60,0-2,5-KU-AL-ESD	Natural	60.0	20.0	8.0	2.5	6.0	M4 × 10 (T)	< 10 <sup>5</sup>	2768-mK	ATS MAxx ATS MA2xx/3xx	
21615	NHS-ST-60,0-2,5-POM-AL	Natural	60.0	20.0	8.0	2.5	6.0	M4 × 10 (T)	–	2768-mK		
23190	NHS-ST-60,0-4,0-KU-AL-ESD	Natural	60.0	20.0	8.0	4.0	6.0	M4 × 10 (T)	< 10 <sup>5</sup>	2768-mK		
43611	NHS-ST-60,0-6,0-KU-AL-ESD	Natural	60.0	20.0	20.0	6.0	6.0	M4 × 10 (T)	< 10 <sup>5</sup>	2768-mK		
18870	NHS-ST-60,0-6,0-PA-AL	Natural	60.0	20.0	20.0	6.0	6.0	M4 × 10 (T)	–	2768-mK		
21577	NHS-ST-63,0-6,0-PA-AL	Natural	63.0	20.0	20.0	6.0	6.0	M4 × 10 (T)	–	2768-mK	–	
35922	NHS-ST-70,0-2,5-POM-AL	Natural	70.0	20.0	8.0	2.5	6.0	M4 × 10 (T)	–	2768-mK	–	
25146	NHS-ST-96,2-3,0-PA-M5	Natural	96.2	19.9	19.9	3.0	10.0	M5 × 10 (T)	–	2768-fH	WS SPEA/3030	

Pushrod (NHS) : rigid (one-part)												
with Part no.	Designation	Colour	Dimensions [mm]					Mounting	ESD R [Ω]	True running (DIN ISO)	Primarily used in	
			LG	LK	LS	DK	DS					
38934	NHS-ST-55,6-2,6-LG-G	Green	55.6	14.5	8.0	2.6	6.2	M4 × 10 (T)	–	0.0 to + 0.7	NDH/VKH (VA xxxx)	
38948	NHS-ST-60,0-2,6-LG-G	Blue	60.0	14.5	8.0	2.6	6.2	M4 × 10 (T)	–	0.0 to + 0.7	ATS MAxx/2xx/3xx	

Pushrod (NHS) : spring-loaded												
Part no.	Designation	Colour	Dimensions [mm]					Mounting	ESD R [Ω]	Installation height	Spring force [N]	Working stroke [mm]
			LG	LK	LS	DK	DS					
49893	NHS-GF-20,0-5,0-KU-ST-ESD	Gold	58.0	20.0	6.0	5.0	3.0	∅ 2.99 (KS)	10 <sup>2</sup> - 10 <sup>4</sup>	18.0	3.0	11.2
13011	NHS-GF-26,2-5,0-KU-ST	Gold	58.0	26.5	6.0	5.0	3.0	∅ 2.99 (KS)	–	24.0	5.0	11.2

P = pin (for plug-in version) | H = hole (for press-in version) | T = internal thread (for screw-in version) | KS = receptacle KS-113 23



## Transfer fields (TF)

### TF-P-SI-0X0-L

- With KT-254 L3 E02
- Solder connection

### TF-P-SI-0X0-WW

- With KT-254 W3 E02
- Wire wrap connection

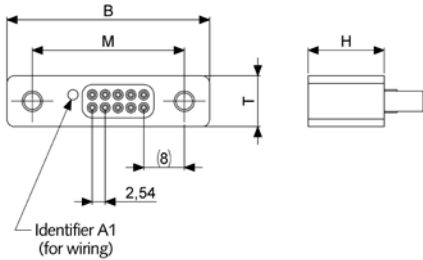

## Tension relief

### TF-X-SI-0X0

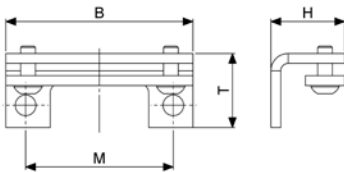
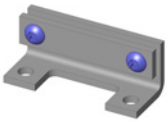

## Usage

Transfer fields (TF) are mounted on the pressure frame plate and/or moving plate, and are used for the transmission of signals from top and/or lateral contacting. The transfer is spring-loaded, which means that the pressure frame plate and/or moving plate can be removed without disrupting the wiring.

## Features

- Simple, quick mounting
- Various sizes (number of poles)
- Various connection types

## Customisation example

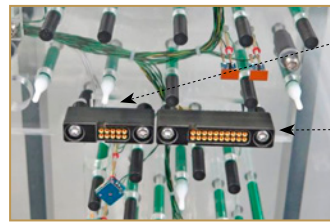

Transfer field (part 48737)

Transfer field (part 48738)

Top contacting with transfer fields (TF)

## Ordering information

Transfer fields (TF)								
Part number	Designation	Design			Dimensions [mm]			
		Type	Number of poles	Connection	W	D	H	M
48737	TF-P-SI-010-L	Signal block	10 (2.54 mm grid)	Solder	40.0	10.0	15.0	30.0
48733	TF-P-SI-010-WW	Signal block	10 (2.54 mm grid)	Wire wrap	40.0	10.0	15.0	30.0
48738	TF-P-SI-020-L	Signal block	20 (2.54 mm grid)	Solder	52.0	10.0	15.0	42.0
48739	TF-P-SI-020-WW	Signal block	20 (2.54 mm grid)	Wire wrap	52.0	10.0	15.0	42.0
48740	TF-P-SI-030-L	Signal block	30 (2.54 mm grid)	Solder	65.5	10.0	15.0	55.5
48741	TF-P-SI-030-WW	Signal block	30 (2.54 mm grid)	Wire wrap	65.5	10.0	15.0	55.5
48742	TF-P-SI-040-L	Signal block	40 (2.54 mm grid)	Solder	78.0	10.0	15.0	68.0
48743	TF-P-SI-040-WW	Signal block	40 (2.54 mm grid)	Wire wrap	78.0	10.0	15.0	68.0

Tension relief								
Part number	Tension relief	Suitable for transfer field	Dimensions [mm]					
			W	D	H	M		
55430	TF-X-SI-010	TF-P-SI-010-L and TF-P-SI-010-WW	38.0	15.0	15.0	30.0		
55431	TF-X-SI-020	TF-P-SI-020-L and TF-P-SI-020-WW	50.0	15.0	15.0	42.0		
55432	TF-X-SI-030	TF-P-SI-030-L and TF-P-SI-030-WW	63.5	15.0	15.0	55.5		
55433	TF-X-SI-040	TF-P-SI-040-L and TF-P-SI-040-WW	76.0	15.0	15.0	68.0		

Spring-loaded test probe		
Part number	Designation	
GKS-100-0031	GKS-100 307 150 A 1500	Spring-loaded test probe for signal transfer, mounted in probe plate

PCB support pins (PAS)

PAS-02,8-03,0



- Tip length: 2.8 mm
- Tip diameter: 3.0 mm
- Total height: 6.8 mm

PAS-02,8-04,0



- Tip length: 2.8 mm
- Tip diameter: 4.0 mm
- Total height: 6.8 mm

PAS-02,8-05,0



- Tip length: 2.8 mm
- Tip diameter: 5.0 mm
- Total height: 6.8 mm

PAS-05,8-03,0



- Tip length: 5.8 mm
- Tip diameter: 3.0 mm
- Total height: 10.8 mm

Usage

PCB support pins (PAS) are used to support the printed circuit board to be tested and are mounted on the moving plate.

Features

- Simple, quick mounting
- Various tip style diameters
- Protection for components
- PCB support pins PAS-02,8-0x,0 are suitable for use in ESD protected areas (EPA) due to their low electrostatic charge

Technical specifications

PCB support pins

- **PAS-02,8-03,0:**
  - Tip length: 2.8 mm
  - Tip diameter: 3.0 mm
  - Pin diameter: 2.0 mm
  - Total height: 6.8 mm
  - Material: PA 6 granulate mixture
- **PAS-02,8-04,0:**
  - Tip length: 2.8 mm
  - Tip diameter: 4.0 mm
  - Pin diameter: 3.0 mm
  - Total height: 6.8 mm
  - Material: POM (black)
- **PAS-02,8-05,0:**
  - Tip length: 2.8 mm
  - Tip diameter: 5.0 mm
  - Pin diameter: 3.0 mm
  - Total height: 6.8 mm
  - Material: PA 6 granulate mixture
- **PAS-05,8-03,0:**
  - Tip length: 5.8 mm
  - Tip diameter: 3.0 mm
  - Pin diameter: 3.0 mm
  - Total height: 10.8 mm
  - Material: FR4

Customisation example



PCB support pin (part 3161)

moving plate with  
 PCB support pins (PAS)

Ordering information

PCB support pins (PAS)		
Part no.: 17990	PAS-02,8-03,0	Tip length: 2.8 mm, tip style diameter: 3.0 mm, total height: 6.8 mm
Part no.: 32995	PAS-02,8-04,0	Tip length: 2.8 mm, tip style diameter: 4.0 mm, total height: 6.8 mm
Part no.: 3161	PAS-02,8-05,0	Tip length: 2.8 mm, tip style diameter: 5.0 mm, total height: 6.8 mm
Part no.: 17806	PAS-05,8-03,0	Tip length: 5.8 mm, tip style diameter: 3.0 mm, total height: 10.8 mm

## Tooling pins (FS)

Tip length: 6.0 mm

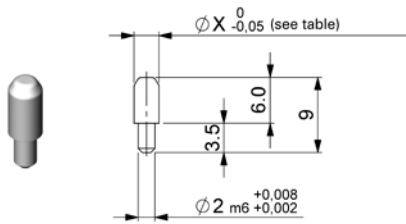

Tip length: 7.0 mm

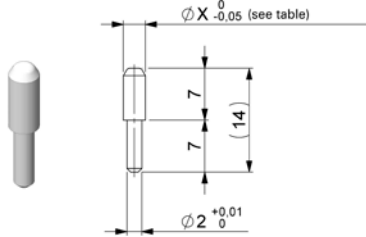

## Usage

Tooling pins (FS) are used to mount printed circuit boards to be tested via the tooling holes, and to position them precisely at the contacting level in the probe field. The tooling pins are mounted in a 2H7 hole in the moving plate.

## Features

- Simple, quick mounting
- Made from stainless steel, available in non-hardened or hardened version
- Tip lengths 6.0 mm (for ADPs = 4 mm) and 7.0 mm (for ADPs = 8 mm)

## Customisation example

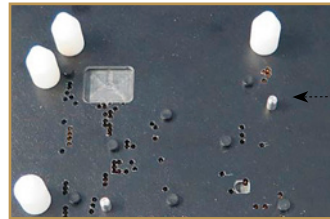

Moving plate with tooling pins (FS)

Tooling pin (part 53312)

## Ordering information

Tooling pins (FS) : Rigid, round, 6.0 mm (tip length) for ADPs = 4 mm – non-hardened			
Part number	ØX	Designation	Type
53301	1.90	FS-1,90-RD-06-02-B	Round with collar
53302	2.00	FS-2,00-RD-06-02-B	Round with collar
53303	2.10	FS-2,10-RD-06-02-B	Round with collar
53304	2.20	FS-2,20-RD-06-02-B	Round with collar
53305	2.30	FS-2,30-RD-06-02	Round
53306	2.40	FS-2,40-RD-06-02	Round
53307	2.50	FS-2,50-RD-06-02	Round
53308	2.60	FS-2,60-RD-06-02	Round
53309	2.70	FS-2,70-RD-06-02	Round
53310	2.80	FS-2,80-RD-06-02	Round
53311	2.90	FS-2,90-RD-06-02	Round
53312	3.00	FS-3,00-RD-06-02	Round
53313	3.10	FS-3,10-RD-06-02	Round
53314	3.20	FS-3,20-RD-06-02	Round
53315	3.30	FS-3,30-RD-06-02	Round
53316	3.40	FS-3,40-RD-06-02	Round
53317	3.50	FS-3,50-RD-06-02	Round
53318	3.60	FS-3,60-RD-06-02	Round
53319	3.70	FS-3,70-RD-06-02	Round
53320	3.80	FS-3,80-RD-06-02	Round
53321	3.90	FS-3,90-RD-06-02	Round
53322	4.00	FS-4,00-RD-06-02	Round
53323	4.10	FS-4,10-RD-06-02	Round
53331	4.20	FS-4,20-RD-06-02	Round
53324	4.30	FS-4,30-RD-06-02	Round
53325	4.40	FS-4,40-RD-06-02	Round
53326	4.50	FS-4,50-RD-06-02	Round
53327	4.60	FS-4,60-RD-06-02	Round
53328	4.70	FS-4,70-RD-06-02	Round
53332	4.80	FS-4,80-RD-06-02	Round
53329	4.90	FS-4,90-RD-06-02	Round
53330	5.00	FS-5,00-RD-06-02	Round

## Ordering information

Tooling pins (FS): Rigid, round, 7.0 mm (tip length) for ADPs = 8 mm							
Non-hardened version				Hardened version			
Part no.	ØX	Designation	Type	Part no.	ØX	Designation	Type
52507	1.50	FS-1,50-RD-07-02-B	Round with collar	38873	1.80	FS-1,80-RD-07-02-G	Round
52506	1.60	FS-1,60-RD-07-02-B	Round with collar	38874	1.90	FS-1,90-RD-07-02-G	Round
52505	1.70	FS-1,70-RD-07-02-B	Round with collar	38875	2.00	FS-2,00-RD-07-02-G	Round
47188	1.80	FS-1,80-RD-07-02-B	Round with collar	38876	2.10	FS-2,10-RD-07-02-G	Round
3165	1.90	FS-1,90-RD-07-02-B	Round with collar	38877	2.20	FS-2,20-RD-07-02-G	Round
3166	2.00	FS-2,00-RD-07-02-B	Round with collar	38878	2.30	FS-2,30-RD-07-02-G	Round
3167	2.10	FS-2,10-RD-07-02-B	Round with collar	38879	2.40	FS-2,40-RD-07-02-G	Round
3168	2.20	FS-2,20-RD-07-02-B	Round with collar	38880	2.50	FS-2,50-RD-07-02-G	Round
3169	2.30	FS-2,30-RD-07-02	Round	38881	2.60	FS-2,60-RD-07-02-G	Round
3170	2.40	FS-2,40-RD-07-02	Round	38882	2.70	FS-2,70-RD-07-02-G	Round
3171	2.50	FS-2,50-RD-07-02	Round	38883	2.80	FS-2,80-RD-07-02-G	Round
3172	2.60	FS-2,60-RD-07-02	Round	38884	2.90	FS-2,90-RD-07-02-G	Round
3173	2.70	FS-2,70-RD-07-02	Round	38885	3.00	FS-3,00-RD-07-02-G	Round
3174	2.80	FS-2,80-RD-07-02	Round	38886	3.10	FS-3,10-RD-07-02-G	Round
3175	2.90	FS-2,90-RD-07-02	Round	38887	3.20	FS-3,20-RD-07-02-G	Round
3176	3.00	FS-3,00-RD-07-02	Round	38888	3.30	FS-3,30-RD-07-02-G	Round
3177	3.10	FS-3,10-RD-07-02	Round	38889	3.40	FS-3,40-RD-07-02-G	Round
3178	3.20	FS-3,20-RD-07-02	Round	38890	3.50	FS-3,50-RD-07-02-G	Round
3179	3.30	FS-3,30-RD-07-02	Round	38891	3.60	FS-3,60-RD-07-02-G	Round
3180	3.40	FS-3,40-RD-07-02	Round	38892	3.70	FS-3,70-RD-07-02-G	Round
3181	3.50	FS-3,50-RD-07-02	Round	38893	3.80	FS-3,80-RD-07-02-G	Round
3182	3.60	FS-3,60-RD-07-02	Round	38894	3.90	FS-3,90-RD-07-02-G	Round
3183	3.70	FS-3,70-RD-07-02	Round	38895	4.00	FS-4,00-RD-07-02-G	Round
3184	3.80	FS-3,80-RD-07-02	Round	42739	4.10	FS-4,10-RD-07-02-G	Round
3185	3.90	FS-3,90-RD-07-02	Round	43790	4.20	FS-4,20-RD-07-02-G	Round
3186	4.00	FS-4,00-RD-07-02	Round	42743	4.30	FS-4,30-RD-07-02-G	Round
3187	4.10	FS-4,10-RD-07-02	Round	42745	4.40	FS-4,40-RD-07-02-G	Round
3188	4.20	FS-4,20-RD-07-02	Round	42746	4.50	FS-4,50-RD-07-02-G	Round
3189	4.30	FS-4,30-RD-07-02	Round	42747	4.60	FS-4,60-RD-07-02-G	Round
3190	4.40	FS-4,40-RD-07-02	Round	42748	4.70	FS-4,70-RD-07-02-G	Round
3191	4.50	FS-4,50-RD-07-02	Round	42749	4.80	FS-4,80-RD-07-02-G	Round
3192	4.60	FS-4,60-RD-07-02	Round	42750	4.90	FS-4,90-RD-07-02-G	Round
3193	4.70	FS-4,70-RD-07-02	Round	42751	5.00	FS-5,00-RD-07-02-G	Round
3194	4.80	FS-4,80-RD-07-02	Round	42752	5.10	FS-5,10-RD-07-02-G	Round
3195	4.90	FS-4,90-RD-07-02	Round	42753	5.20	FS-5,20-RD-07-02-G	Round
3196	5.00	FS-5,00-RD-07-02	Round	42754	5.30	FS-5,30-RD-07-02-G	Round
				42755	5.40	FS-5,40-RD-07-02-G	Round
				42756	5.50	FS-5,50-RD-07-02-G	Round
				42757	5.60	FS-5,60-RD-07-02-G	Round
				42758	5.70	FS-5,70-RD-07-02-G	Round
				42759	5.80	FS-5,80-RD-07-02-G	Round
				42760	5.90	FS-5,90-RD-07-02-G	Round
				42761	6.00	FS-6,00-RD-07-02-G	Round

Series: GFS

Design: Spring-loaded

Type: Round | sword-shaped

Mounting: crimped onto probe plate | onto moving plate

## Tooling pins (GFS)

### Spring-loaded with external spring

– Mounting on **probe plate** (KTP)

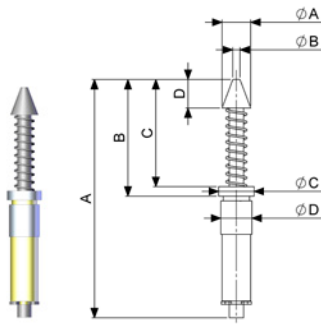

### Spring-loaded with friction bearing

– Mounting on **moving plate** (ADP)

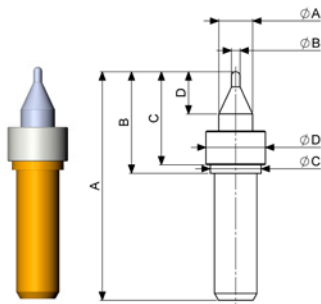

- High-precision and low-wear
- Head material: carbide
- Incl. friction bearing guide

- A = total length
- B = tooling pin length with mounting end stop (collar)
- C = tooling pin length without mounting end stop (collar)
- D = tip length
- ØA = max. tip style diameter
- ØB = min. tip style diameter
- ØC = mounting end stop (collar) diameter
- ØD = mounting sleeve diameter

## Usage

Spring-loaded tooling pins (GFS) are used to spring-mount the printed circuit boards to be tested using the tooling holes, and position them precisely at the contacting level in the probe field. Depending on the design, the spring-loaded tooling pins are mounted either on the probe plate (KTP) or the moving plate (ADP). The collar of the tooling pin must always sit flush on the KTP or ADP.

## Features

- Simple, quick mounting
- Optimal compensation for tolerances
- Compact types
- Mounting is dependent on the design, and is either on the probe plate (KTP) or the moving plate (ADP)

## Tooling pin combinations for GFS with friction bearing guide

Depending on the geometry of the tooling holes and/or tolerance accuracy of the PCB, the following tooling pin combinations can be used:

- Round/round
- Round/sword-shaped



The longest side of the sword-shaped pin must always be vertically aligned to the tooling hole clearance.

## Customisation example

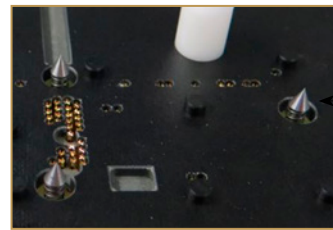

Probe plate with spring-loaded tooling pins (GFS)

Spring-loaded tooling pin (part 21824)

## Ordering information

Tooling pins (GFS): spring-loaded with external spring – mounting: probe plate (KTP)													
Part no.	Designation	Shape	Dimensions [mm]								Stroke max. [mm]	Spring force	
			A	B	C	D	ØA	ØB	ØC	ØD		min. [N]	max. [N]
21824	GFS-4,50-RD-25-06,5-B	Round (cone)	50.0	24.5	22.5	5.0	4.5	–	7.4	6.5	10.0	2.4	5.7
24311	GFS-4,50-RD-29-06,5-B	Round (cone)	50.0	28.5	22.5	5.0	4.5	–	7.4	6.5	10.0	2.4	5.7
20889	GFS-6,00-1,50-RD-25-06,5-B	Round (cone)	50.0	24.5	22.5	6.0	6.0	1.5	7.4	6.5	10.0	2.4	5.7
22278	GFS-6,00-1,50-RD-29-06,5-B	Round (cone)	50.0	28.6	22.6	6.0	6.0	1.5	7.4	6.5	10.0	2.4	5.7
36406	GFS-7,00-1,50-RD-23-06,5-B	Round (cone)	49.5	22.5	20.5	4.0	7.0	1.5	7.4	6.5	10.0	2.4	5.7
47042	GFS-8,00-1,65-RD-16-06,5-B	Round (cone)	41.5	15.5	13.5	6.0	8.0	1.65	7.4	6.5	10.0	2.4	5.7

Tooling pins (GFS): spring-loaded with friction bearing – mounting: moving plate (ADP)													
Part no.	Designation	Shape	Dimensions [mm]								Stroke max. [mm]	Spring force	
			A	W	C	D	ØA	ØB	ØC	ØD		min. [N]	max. [N]
For tooling holes Ø 2.0 mm to Ø 3.5 mm (including friction bearing guide, part 24482)													
24481	GFS-3,98-RD-12,0-05,0-B-G	Round (cone)	27.0	12.0	11.0	5.0	3.98	1.0	6.0	7.0	5.0	1.7	3.0
25214	GFS-3,98-SW-12,0-05,5-B-G	Sword-shaped	27.0	12.0	11.0	5.0	3.98	1.0	6.5	7.0	5.0	1.7	3.0
For tooling holes Ø 3.5 mm to Ø 5.5 mm (including friction bearing guide, part 25216)													
25215	GFS-5,98-RD-12,0-08,0-B-G	Round (cone)	27.0	12.0	11.0	5.3	5.98	2.5	9.0	10.0	5.0	2.0	3.0
25217	GFS-5,98-SW-12,0-08,0-B-G	Sword-shaped	27.0	12.0	11.0	5.3	5.98	2.5	9.0	10.0	5.0	2.0	3.0



## Tooling pins (FS)

For Keysight inline interchangeable kits  
 WS Keysight/i3070-5i

Types:

Round    Sword-shaped    3-edged chisel

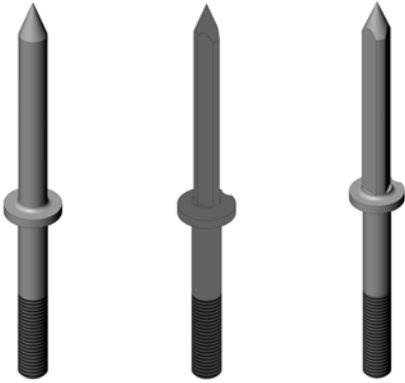

### Usage

Precision-manufactured tooling pins (FS) are available with round, sword-shaped and 3-edged chisel tip styles for the customisation of Keysight in-line interchangeable kits. The tooling pins are mounted on the probe plate (KTP), for which a 3H7 borehole is required. The tooling pin is reliably secured using a nut that is screwed onto the thread from below. The collar of the tooling pin must always sit flush on the KTP. The following provides guidance on the ideal tooling pin diameter:

$$\text{Tooling pin } \varnothing = \text{minimum PCB tooling hole diameter} - 0.03 \text{ mm}$$

### Features

- Simple, quick mounting
- Made from stainless steel, available in hardened version
- Tip length 26 mm

### Tooling pin combinations

Depending on the geometry of the tooling holes and/or tolerance accuracy of the PCB, the following tooling pin combinations can be used:

- Round/round
- Round/sword-shaped
- Triangular/sword-shaped



The longest side of the sword-shaped pin must always be vertically aligned to the tooling hole clearance.

## Ordering information

### Tooling pins (FS) : Rigid, round, 26.0 mm (tip length) – hardened

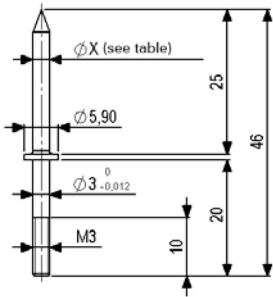

Part no.	ØX	Designation	Type
53454	1.72	FS-1,72-RD-26-03-M3-B-G	Round with collar
58599	1.90	FS-1,90-RD-26-03-M3-B-G	Round with collar
55025	2.42	FS-2,42-RD-26-03-M3-B-G	Round with collar
51737	2.92	FS-2,92-RD-26-03-M3-B-G	Round with collar
34651	3.42	FS-3,42-RD-26-03-M3-B-G	Round with collar
51728	3.92	FS-3,92-RD-26-03-M3-B-G	Round with collar
53919	3.97	FS-3,97-RD-26-03-M3-B-G	Round with collar
55577	5.42	FS-5,42-RD-26-03-M3-B-G	Round with collar

### Tooling pins (FS) : Rigid, sword-shaped, 26.0 mm (tip length) – hardened

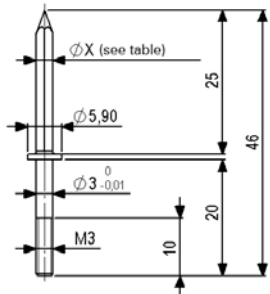

Part no.	ØX	Designation	Type
51738	2.42	FS-2,42-SW-26-03-M3-B-G	Sword-shaped with collar
51729	2.92	FS-2,92-SW-26-03-M3-B-G	Sword-shaped with collar
52249	3.92	FS-3,92-SW-26-03-M3-B-G	Sword-shaped with collar
53968	3.97	FS-3,97-SW-26-03-M3-B-G	Sword-shaped with collar
55578	5.42	FS-5,42-SW-26-03-M3-B-G	Sword-shaped with collar

### Tooling pins (FS) : Rigid, 3-edged chisel, 26.0 mm (tip length) – hardened

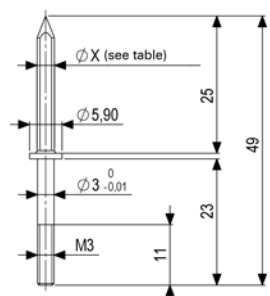

Part no.	ØX	Designation	Type
37710	3.20	FS-3,20-DK-26-03-M3-B-G	Triangular with collar
34652	3.92	FS-3,92-DK-26-03-M3-B-G	Triangular with collar

## Centric pre-centring pins (VZ)

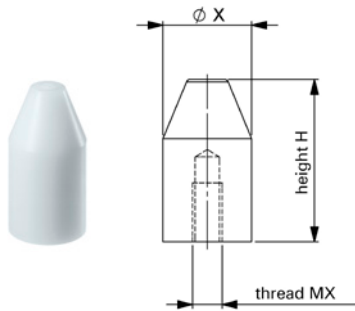

## Usage

Pre-centring pins (VZ) are mounted onto the moving plate, and are used as insertion aids to pre-position DUTs simply and quickly on the probe field.

## Features

- Simple, quick mounting
- Various diameters
- Various heights
- Centric and eccentric versions

## Eccentric pre-centring pins (VZ)

VZ-R-8-26-M-X | VZ-R-8-41-M-X

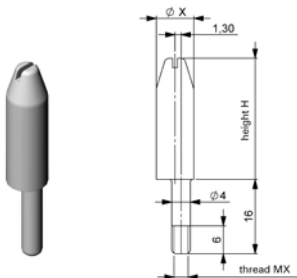

## Customisation example

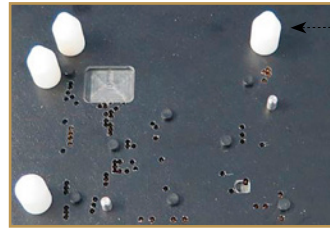

Pre-centring pin (part 13781)

Moving plate with pre-centring pins (VZ)

VZ-R-12-22-K-X

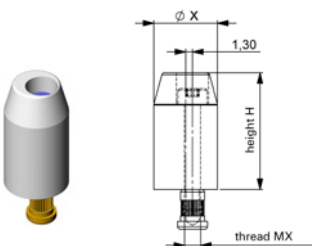

## Ordering information

Centric pre-centring pins (VZ)						
Part no.	Designation	$\varnothing X$	Height H	Thread MX	Design	Material
25519	VZ-R-6-12,5-K	6 mm	12.5 mm	M3	Round	POM (black)
21628	VZ-R-10-12,5-K	10 mm	12.5 mm	M4	Round	POM (black)
20616	VZ-R-12-19-K	12 mm	19 mm	M4	Round	POM (natural)
13781	VZ-R-12-22-K	12 mm	22 mm	M4	Round	POM (natural)
23056	VZ-R-12-22-K-ESD	12 mm	22 mm	M4	Round, antistatic	EGS T23 AS (black)
19462	VZ-R-12-28-K	12 mm	28 mm	M4	Round	POM (natural)
50021	VZ-R-12-35-K	12 mm	35 mm	M4	Round	POM (natural)
44253	VZ-R-12-42-K-ESD	12 mm	42 mm	M4	Round, antistatic	PE (black)
46758	VZ-R-12-50-K	12 mm	50 mm	M4	Round	POM (natural)

Eccentric pre-centring pins (VZ)						
Part no.	Designation	$\varnothing X$	Height H	Thread MX	Design	Material
2518	VZ-R-8-26-M-X	8 mm	26 mm	M4 (pin)	Round	Steel (1.0037)
2519	VZ-R-8-41-M-X	8 mm	41 mm	M4 (pin)	Round	Steel (1.0037)
42295	VZ-R-12-22-K-X	12 mm	22 mm	M3 (bush)	Round	POM (natural)

Series: FED

Type: Pressure spring

Diameter: 10 mm | 11.6 mm | 12 mm | 12.1 mm

Mounting: Press in

Springs (FED)



Usage

Springs (FED) are mounted on the probe plate and are used as a pressure element in order to lift the probe plate with the DUT back to the original level following contacting.

Features

- Simple, quick mounting
- Various diameters
- Various heights
- Various spring forces

Schematic diagram

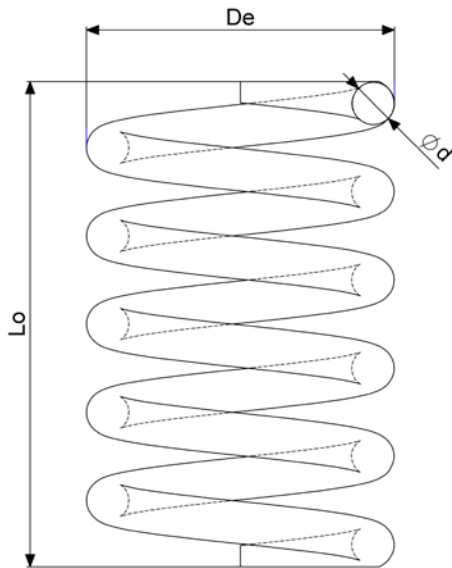

- De = Outer winding diameter
- Lo = Non-tensioned length
- Ln = Length at rated force
- Fn = Rated force at max. permitted stroke
- d = Wire diameter

Customisation example



Exchangeable kit ATS MAxx with springs (FED)

Ordering information

Springs (FED)							
Part number	Designation	De approx. [mm]	Lo approx. [mm]	Ln approx. [mm]	Fn approx. [N]	d [mm]	Primarily used in
19994	FED-04,7-14,0-20N-07,5	4.6	14.0	7.5	19.2	0.63	-
2785	FED-10,0-15,0-87N-09,0	10.0	15.0	9.0	87	0.63	-
1571	FED-10,0-16,0-97N-09,0	10.0	16.0	9.0	97	1.40	VA 1-stage test fixture
2784	FED-10,0-16,0-100N-09,5	10.0	16.0	9.5	100	1.40	-
1581	FED-10,0-21,5-135N-09,7	10.0	21.5	9.7	135	1.35	VA 2-stage test fixture
1584	FED-11,6-26,0-08N-04,7	11.6	26.0	4.7	7.4	0.63	ATS PAZxxx/ATS PAxxxx
1583	FED-12,0-23,0-15N-05,5	12.0	23.0	5.5	14.9	0.80	ATS MAxxx
43627	FED-12,1-31,0-20N-08,4	12.1	31.0	8.4	19.6	0.90	ATS MAxx

## Gas pressure springs (GDF)

### GDF-xxx-xxx-xxxN-A6-A6-x



(plunger is shown extended)

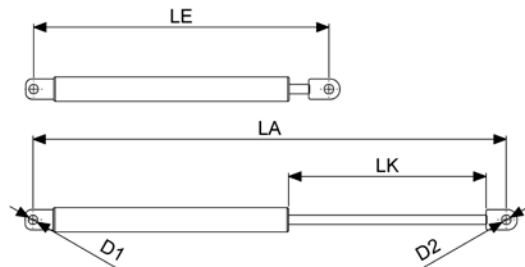

- LE = Gas pressure spring length retracted
- LA = Gas pressure spring length extended
- LK = Length with plunger extended
- D1 = Mounting diameter 1
- D2 = Mounting diameter 2

## Usage

Gas pressure springs (GDF) are used to counterbalance weights and are used as supportive opening and holding mechanisms in test fixtures.

## Features

- Simple, quick mounting
- Various lengths
- Various forces
- Typical life span: approx. 50,000 load cycles

## Customisation example

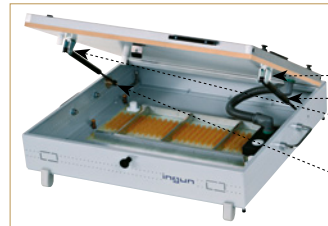

Vacuum test fixture  
 VA 2040/F/H/TD 88xx-S with  
 gas pressure springs (GDF)

## Ordering information

Gas pressure springs (GDF)									
Part no.	Designation	Stroke [mm]	Force [N]	Dimensions [mm]					Design
				LE	LA	LK	D1	D2	
2499	GDF-145-40-50N-A6-A6	40	50	105	145	49	6.0	6.2	-
2504	GDF-145-40-100N-A6-A6	40	100	105	145	49	6.0	6.2	-
2497	GDF-185-60-50N-A6-A6	60	50	125	185	68	6.2	6.2	-
16548	GDF-185-60-75N-A6-A6	60	75	125	185	68	6.2	6.2	-
11536	GDF-185-60-100N-A6-A6	60	100	125	185	68	6.3	6.3	-
38786	GDF-185-60-100N-A6-A6-D	60	100	125	185	68	6.3	6.3	Dynamic shock absorption
34848	GDF-185-60-150N-A6-A6	60	150	125	185	68	6.3	6.3	-
31788	GDF-185-60-200N-A6-A6	60	200	125	185	68	6.3	6.3	-
37967	GDF-185-60-200N-A6-A6-D	60	200	125	185	68	6.3	6.3	Dynamic shock absorption
35469	GDF-185-60-300N-A6-A6	60	300	125	185	68	6.3	6.3	-
25695	GDF-220-50-50N-A6-A6	50	50	170	220	50	6.2	6.2	-
25696	GDF-270-100-75N-A6-A6	100	75	170	270	102	6.1	6.1	-
26716	GDF-270-100-150N-A6-A6	100	150	170	270	102	6.1	6.1	-
2500	GDF-305-120-50N-A6-A6	120	50	185	305	127	6.0	6.2	-
2501	GDF-305-120-75N-A6-A6	120	75	185	305	127	6.0	6.2	-
2502	GDF-305-120-100N-A6-A6	120	100	185	305	127	6.0	6.2	-
10770	GDF-305-120-150N-A6-A6	120	150	185	305	127	6.1	6.2	-
8078	GDF-305-120-200N-A6-A6	120	200	185	305	127	6.0	6.2	-
9991	GDF-305-120-300N-A6-A6	120	300	185	305	127	6.0	6.2	-

Accessories		
Part no.: 2348	Bearing block LBN-12/16	Bearing block for mounting, including. 2 x SL retainer d6
Part no.: 12440	GDF housing mounting	Mounting column H = 25 (4/14/7) mm for mounting, without SL retainer d6
Part no.: 17053	GDF cover mounting	Mounting column H = 18 (4/7/7) mm for mounting, without SL retainer d6
Part no.: 49317	SL retainer d6	Retainer for fixing gas pressure springs to bolts and shafts

## Multipoint connectors (VG)

Number of poles: **64**

VG-M-064-ac-WW-G13-SET

(for exchangeable kits ATS MA xxx)



- Male multipoint connector (set)
- Wire wrap connection
- Incl. hexagon bolts and mounting material

VG-M-064-ac-WW-G13



- Male multipoint connector
- Wire wrap connection

VG-F-064-ac-WW-G13



- Female socket connector
- Wire wrap connection

VG-F-064-ac-L-G04

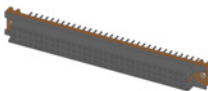

- Female socket connector
- Solder connection

Number of poles: **96**

VG-M-096-abc-WW-G13-SET

(for exchangeable kits ATS MA xxx)



- Male multipoint connector (set)
- Wire wrap connection
- Incl. hexagon bolts and mounting material

VG-M-096-abc-WW-G13

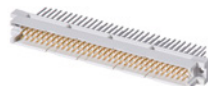

- Male multipoint connector
- Wire wrap connection

VG-F-096-abc-WW-G13



- Female socket connector
- Wire wrap connection

VG-F-096-abc-L-G04

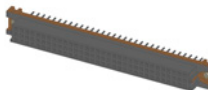

- Female socket connector
- Solder connection

## Usage

Multipoint connectors (VG) are used as pluggable connectors for multi-pole electrical signal transmission in low-voltage applications, such as for connecting the PCB contacting to the test system, for example.

## Features

- Simple, quick, space-saving mounting
- Reliable signal transmission
- Wire wrap or solder connection

## Technical specifications

Multipoint connectors (VG) as per DIN 41612 (IEC 60603-2)

- Type: C
- Type: male/female socket connector
- Design: straight
- Material: gold-plated contacts
- Number of poles: 64 | 96
- Row configuration: a/c (64-pole) | a/b/c (96-pole)
- Grid: 2.54 mm
- Rated current: 2 A
- Connection: wire wrap | solder connection
- Post length: 13 mm (multipoint with wire wrap connection)  
4 mm (multipoint with solder connection)

## Suitable multipoint connectors for exchangeable kits ATS MAxxx

- Part 43135 VG-M-064-ac-WW-G13-SET
  - Part 47910 VG-M-096-abc-WW-G13-SET
- (delivery includes hexagon bolts and mounting material)

## Customisation example

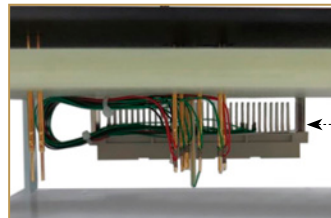

Connection of PCB contacting to multipoint connector (set) for ATS MA360

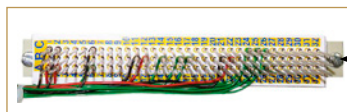

Male multipoint connector set (part 43135)

Address panel (part 13133)

## Ordering information

Multipoint connectors (VG) – 64 poles		
Part no.: 43135	VG-M-064-ac-WW-G13-SET	Male multipoint connector, wire wrap connection, for ex. kits ATS MAxxx
Part no.: 4864	VG-M-064-ac-WW-G13	Male multipoint connector, wire wrap connection
Part no.: 8256	VG-F-064-ac-WW-G13	Female socket connector, wire wrap connection
Part no.: 4865	VG-F-064-ac-L-G04	Female socket connector, solder connection
Multipoint connectors (VG) – 96 poles		
Part no.: 47910	VG-M-096-abc-WW-G13-SET	Male multipoint connector, wire wrap connection, for ex. kits ATS MAxxx
Part no.: 5195	VG-M-096-abc-WW-G13	Male multipoint connector, wire wrap connection
Part no.: 8257	VG-F-096-abc-WW-G13	Female socket connector, wire wrap connection
Part no.: 10422	VG-F-096-abc-L-G04	Female socket connector, solder connection
Accessories		
Part no.: 13133	LAB-PB-096-abc-WW-BL-VG	Address panel with pin configuration (85 × 11.2 mm) for 64-pole and 96-pole multipoint connectors



## Cleaning mats (KRM)

### KRM-400-690-09

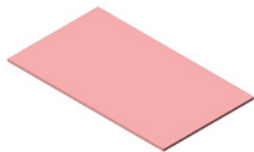

- Outer dimensions (W × D × H): 690 × 400 × 9 ±3 mm
- Material: silicone / quartz powder mixture

### KRM-460-690-09

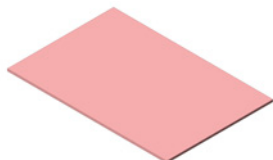

- Outer dimensions (W × D × H): 690 × 460 × 9 ±3 mm
- Material: silicone / quartz powder mixture

## Usage

Cleaning mats (KRM) are used to clean contaminated test probe tips. A cleaning mat cut to the same size as the DUT is placed in the test fixture instead of the DUT. When the fixture is closed, the tips of the test probes are pressed into the cleaning mat. The specialised composition of the cleaning mats works to clean the test probe tips. The cleaning of the test probe tips is a simple measure that helps to prolong the life span of the test probes. However, even regular cleaning cannot prolong the life span of the test probes indefinitely.

It is recommended that heavily contaminated test probes are cleaned daily before starting work. Test probes which are used less often, or which only have light contamination, can be cleaned once a week.

## Application range

This type of cleaning is recommended in particular for sharp tip styles, which have self-cleaning features (such as tip styles 01, 09, 15, 31, 77, 91, 93, 97 and 98). Only with these styles is there a possibility of scrubbing away contamination from the test probe tip.

## Technical specifications

- Material: silicone/quartz powder mixture
- Special feature: static electricity charge possible
- Recommended puncture depth: > 0.5 mm
- Mechanical load capacity: approx. 1,000 penetration cycles (laboratory conditions)

## Results of cleaning

Contaminated test probe, contacted on gold-plated PCB pads, after various cleaning stages:

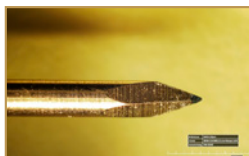

Test probe tip after 0 penetration cycles



Test probe tip after 5 penetration cycles



Test probe tip after 10 penetration cycles

### Note:



The cleaning efficiency and the mechanical load capacity were determined in the laboratory using fully automatic, computer-controlled endurance test stations. Since the life span depends on many different factors and in particular on the individual test application, INGUN cannot guarantee the actual duration of use in the test field.

## Ordering information

Cleaning mats (KRM)		
Part no.: 56718	KRM-400-690-09	Cleaning mat with outer dimensions 690 × 400 × 9 ± 3 mm (W × D × H)
Part no.: 56950	KRM-460-690-09	Cleaning mat with outer dimensions 690 × 460 × 9 ± 3 mm (W × D × H)



## Guide bushes (FUB) and guide pins (FUS)

Guide bushes with precisely fitting guide pins are used for precise, low-friction contacting movements, primarily in order to minimise the side forces and torsional forces affecting the stroke movement.

	Part no.	Designation	Version
	2196	Guide bush FUB-08-14-35-POM-BL-B	– Guide diameter: 8.15 mm – Outer diameter: 14 mm – Total height: 35 mm – Material: POM (blue) – Design: with collar 1 × Ø 15 mm – Mounting: pressed into probe plate
	2229	Guide pin FUS-08-30-ST-M4	– Guide diameter: 8 mm – Total height: 30 mm – Material: steel – Design: internal thread M4 – Mounting: screwed into the moving plate
	2230	Guide pin FUS-08-24-38-ST-F-M4	– Guide diameter: 8 mm – Outer diameter: 23.8 mm – Total height: 38 mm – Material: steel – Design: with mounting flange 3.5 × Ø 23.8 mm – Mounting: screwed into the moving plate

## Stroke-limiting disk and stroke-limiting pin (HBS)

Stroke-limiting disks/pins are used as a height end stop in single-stage and dual-stage vacuum test fixtures to control the parallel contacting stroke in ICT contacting and combined FCT/ICT contacting.

	Part no.	Designation	Design
	2579	Stroke limiting disc HBS-01,0-10,0	– Disk height: 1.0 mm – Outer diameter: 10 mm – Inner diameter: 5 mm – Usage: single-stage vacuum test fixtures – Mounting: affixed to probe plate
	11890	Stroke limiting pin HBS-05,0-07,0	– Die height: 5.0 mm – Outer diameter: 7.0 mm – Pin height: 1.5 mm – Pin diameter: 6.1 mm – Usage: dual-stage vacuum test fixtures – Mounting: crimped onto shifting plate

## ESD kits

ESD kits are mounted on moving plates and probe plates to dissipate any electrostatic charge that occurs as a result of potential differences.

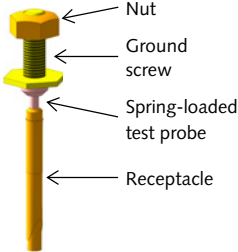
	Part no.	ESD kits for	Delivery includes
	41899	Exchangeable kits ATS MAxx/ATS MAxxx	Ground screw, nut, receptacle, spring-loaded test probe
	4137	Single-stage vacuum test fixtures	Ground screw, nut, receptacle, spring-loaded test probe
	17036	Dual-stage vacuum test fixtures	Ground screw, nut, receptacle, spring-loaded test probe
	22111	Single-stage Keysight interchangeable kit i3070-5i	Ground screw, nut, receptacle, spring-loaded test probe, resistor, solder eyelet, screw, ESD sticker
	22112	Dual-stage Keysight interchangeable kit i3070-5i	Ground screw, nut, receptacle, spring-loaded test probe, resistor, solder eyelet, screw, ESD sticker
	60290	Inline interchangeable kits WS SPEA/3030	Ground screw, threaded bushing, receptacle, spring-loaded test probe

**Products:**

- Stroke sensors (HMK)
- Snap-on fasteners
- Stroke counters (HZ)

## Stroke sensors (HMK)

Stroke sensors are used to detect states (e.g. contacting stroke, DUT in position, etc.) in test fixtures and exchangeable kits.

	Part no.	Designation	Version	Features, scope of delivery
	3308	Stroke sensor, without – KS – GKS	Base unit for parts 3408-KIT, 3409, 37667	Rotary disc with micro switch, can be freely adjusted to configure the optimum stroke position for the spring-loaded test probe.
	3408-KIT	Stroke sensor, including – KS-113 23 – GKS-503 205 180 R 1502	For single-stage vacuum test fixtures	Delivery includes (parts 3408-KIT, 3409, 37667): – Mounting bracket
	3409	Stroke sensor, including – KS-113 23 – GKS-504 305 180 N 3010	For dual-stage vacuum test fixtures	– Rotary disc– Micro switch – Receptacle
	37667	Stroke sensor, including – KS-113 23 – GKS-504 305 180 N 0504	For single-stage MAxx exchangeable kits	– Spring-loaded test probe – Mounting material

## Snap-on fasteners

Snap-on fasteners with various retention forces are primarily used with vacuum covers for supplementary mechanical guard locking.

	Part no.	Designation	Version	
	15536	Mechanical snap-on fastener with 13 N retention force	– Retention force: 13 N – Mechanism: guard locking with spring – Design: corrosion and vibration resistant – Mounting: adjustable using slotted hole, for compensation of tolerances	
	15537	Mechanical snap-on fastener with 22 N retention force	– Retention force: 22 N – Mechanism: guard locking with spring – Design: corrosion and vibration resistant – Mounting: adjustable using slotted hole, for compensation of tolerances	
	15538	Mechanical snap-on fastener with 44 N retention force	– Retention force: 44 N – Mechanism: guard locking with spring – Design: corrosion- and vibration-resistant – Mounting: adjustable using slotted hole, for compensation of tolerances	

## Stroke counters (HZ)

Stroke counters as batch counters for front installation with external / manual resetting

	Part no.	Designation	Version	
	11224	Stroke counter – Total counter from Omron H7EC-N incl. mounting frame Y92F-35	– Display: 7-segment LCD – Power source: integrated battery – Resetting: external/manual reset – Outer dimensions (W × D × H): 48 × 55 × 24 mm – Installation dimensions (W × D × H): 44.8 × 48.5 × 22 mm – Counting speed: 30 Hz/1 kHz switchable	
	34865	Stroke counter – Total counter from Hengstler Tico 731	– Display: 8-segment LCD – Power source: integrated battery – Resetting: external/manual reset – Outer dimensions (W × D × H): 48 × 40 × 24 mm – Installation dimensions (W × D × H): 45 × 32 × 22 mm – Counting speed: 30 Hz	

## Feasa LED analysers

Feasa LED analysers are used for the simultaneous testing of multiple LEDs for colour, brightness and intensity. Two designs are available, **Feasa-F** (FCT = with housing) and **Feasa-I** (ICT = without housing).

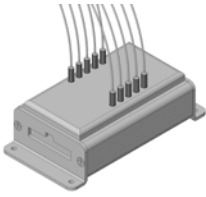

 <p>Feasa-F 10-channel LED analyser</p>	1. Feasa-F LED analyser (FCT = with housing)	
	Part no.	Version
	33685	Feasa-F 20-channel LED analyser, incl. 20× optical head OH-3 for fibre optic cables with Ø cladding = 1 mm
	31211	Feasa-F 10-channel LED analyser, incl. 10× optical head OH-3 for fibre optic cables with Ø cladding = 1 mm
	34811	Feasa-F 6-channel LED analyser, incl. 6× optical head OH-3 for fibre optic cables with Ø cladding = 1 mm
	38918	Feasa-F 3-channel LED analyser, incl. 3× optical head OH-3 for fibre optic cables with Ø cladding = 1 mm
	2. Feasa-I LED analyser (ICT = without housing)	
	Part no.	Version
	33684	Feasa-I 20-channel LED analyser, incl. 20× optical head OH-3 for fibre optic cables with Ø cladding = 1 mm
	31210	Feasa-I 10-channel LED analyser, incl. 10× optical head OH-3 for fibre optic cables with Ø cladding = 1 mm

## Fibre optic cables (LWL)

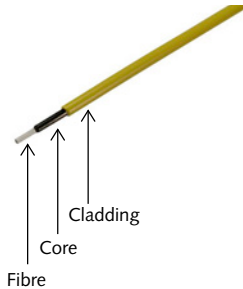
Rugged polymer fibre optic cables for quick, simple plug fitting.

	Part no.	Designation	Technical specifications
 <p>LL-2,3-1,5 Fibre optic cable yellow</p>	39910	LL-2,3-1,5 Yellow fibre optic cable	– Cladding diameter: CLD = 2.3 mm – Core diameter: COD = 1.5 mm – Fibre count: 1× – Cladding material: PA polyamide – Minimum bending radius: 30 mm – Operating temperature range: - 40 °C to + 85 °C – RoHS (2011/65/EC): compliant – Unit of sale: per metre, lengths on request
	33330	LL-1,0-0,5 Black fibre optic cable	– Cladding diameter: CLD = 1.0 mm – Core diameter: COD = 0.5 mm – Fibre count: 1× – Cladding material: PE polyethylene – Minimum bending radius: 20 mm – Operating temperature range: - 40 °C to + 70 °C – RoHS (2011/65/EC): compliant – Unit of sale: per metre, lengths on request

## Compressed air hose (PUN)

	Part no.	Designation	Technical specifications
	26707	Compressed air hose PUN-4x0,75-BL	– Outer diameter: OD = 4.0 mm – Minimum bending radius: 8 mm – Operating temperature range: - 35 °C to + 60 °C – Colour: blue – RoHS (2011/65/EC): compliant – Unit of sale: per metre, lengths on request
	32752	Compressed air hose PUN-CM-4-SW	– Outer diameter: OD = 4.0 mm – Minimum bending radius: 5 mm – Operating temperature range: - 35 °C to + 60 °C – Colour: black – Design: antistatic – Unit of sale: per metre, lengths on request

# Test probes for interfaces

from INGUN, GenRad, Pylon, R & S, Teststation, Teradyne and Keysight (Agilent/HP 3070)

## Installation and functional dimensions

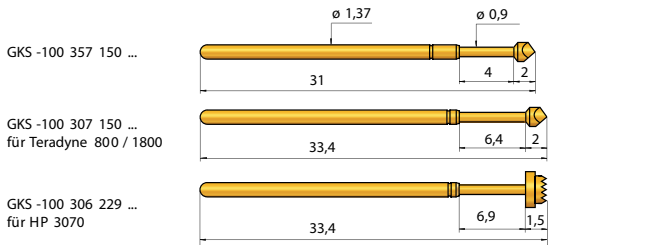
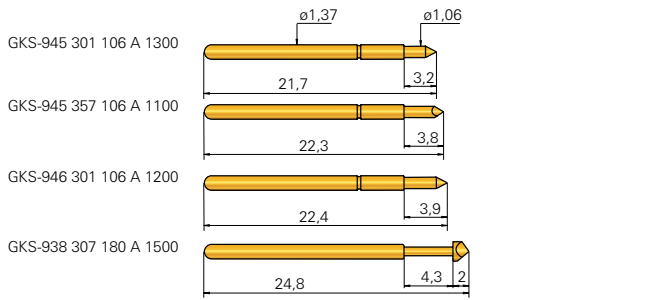

### Receptacles

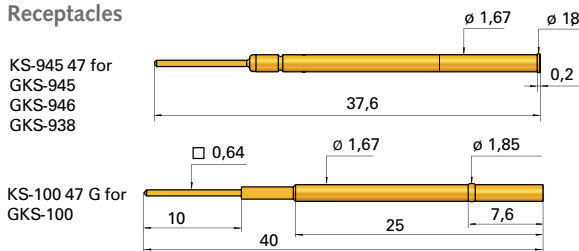

### Mechanical specifications

Type	Working stroke mm	Max. stroke mm	Spring force(s) at working stroke N	Installation height with KS mm
945 301	2.1	3.20	1.3	3.7 *
945 357	2.6	3.20	1.1	4.3 *
946 301	3.2	3.90	1.2	4.4 *
938 307	3.6	4.30	1.5	6.8 *
100 357	3.0	4.00	1.2 (ord. des.=10)	13.6/variable **
100 ...	4.3	6.35	1.0/2.0/2.25/3.0	16.0/variable **

\* with KS-945 47    \*\* with KS-100 47 G

### Mounting hole \*\*\*

**for KS-945 47:**  
 – in CEM 1                    ø 1.68–1.69 mm  
**for KS-100 47 G:**  
 – Countersunk press ring  
**in CEM1:**                    ø 1.71–1.73 mm  
**in FR4:**                      ø 1.70–1.72 mm

### Materials

**Plunger:**                    CuBe, gold-plated  
**Probe barrel:**            nickel-silver or bronze, gold-plated  
**Spring:**                    steel, gold-plated

### Collar and installation height

The installation heights can be configured by countersinking the press ring.

### Electrical specifications

**Current rating:**            4–5 A  
**R<sub>i</sub> typical:**                 20 mΩ

### Operating temperature

**Standard:**                 – 40 °C to + 80 °C

GKS-945/946 for GenRad/Pylon/R&S interfaces				
Material	Tip style	Plating	Other versions	
			ø	ø (inch)
3 01		A	ø 1.06	
3 57*		A	ø 1.06	

\* Available for GKS-945 only

GKS-938				
Material	Tip style	Plating	Other versions	
			ø	ø (inch)
3 07		A	ø 1.80	

GKS-100				
Material	Tip style	Plating	Other versions	
			ø	ø (inch)
3 57		A	ø 1.50	

GKS-100 for Teradyne 800/1800 interface				
Material	Tip style	Plating	Other versions	
			ø	ø (inch)
3 07		A	ø 1.50	

GKS-100 for Agilent/HP 3070 interface				
Material	Tip style	Plating	Other versions	
			ø	ø (inch)
3 06		A	ø 3.1 ø 2.29	

### \*\*\* Service:

Customised contact blocks drilled according to customer demands (and which match certain INGUN receptacles) are available from INGUN.

### Note:

To order test probe with bent receptacle end, use special designation 'B'.

Contact terminals for various interfaces available upon request.

## Ordering example

Series	Tip material 3 = CuBe	Tip style	Tip diameter (1/100 mm)	Plating A = Gold	Spring force (dN)	Collar height (mm)	Special designation (‘B’ – see note)
--------	--------------------------	-----------	----------------------------	---------------------	----------------------	-----------------------	---

Test probe:

G K S 9 4 5 3 0 1 1 0 6 A 1 3 0 0

Receptacle for GKS 945/946/938:

K S - 9 4 5 4 7

Receptacle for GKS-100:

K S - 1 0 0 4 7 G



**Grid:**  
 ≥ 2,54 mm  
 ≥ 100 Mil

**Contact terminals with collar height: 3 mm (.118)**

**KT-254 W-E03 (wire-wrap)**

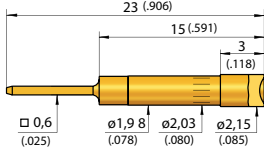

**KT-254 W3 E03 (wire-wrap)**

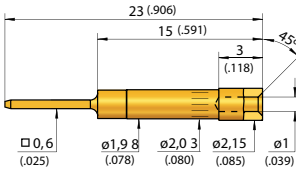

**KT-254 L-E03 (Solder)**

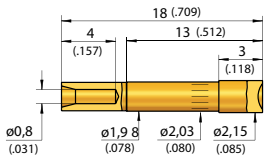

**KT-254 L3 E03 (Solder)**

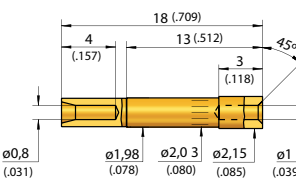

**KT-120 L3 E02 - 30 (Solder)**  
 High-current Contact Terminal

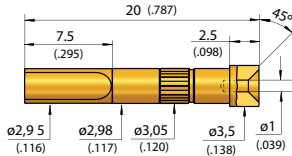

**KT-150 L3 E03 - M3**  
 High-current Contact Terminal

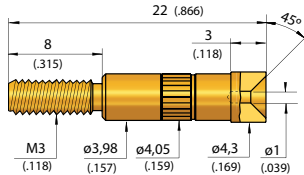

**Contact terminals with collar height: 2 mm (.079)**

**KT-254 W-E02 (wire-wrap)**

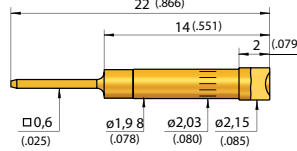

**KT-254 W3 E02 (wire-wrap)**

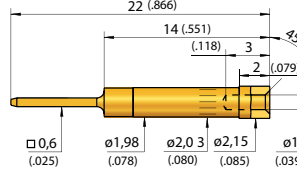

**KT-254 L-E02 (Solder)**

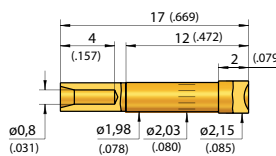

**KT-254 L3 E02 (Solder)**

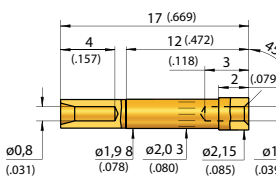

**KT-254 L3 E02 - 30 (Solder Connection)**

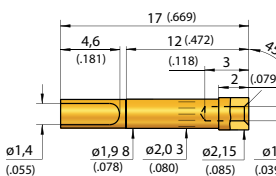

**KT-254 W-PL (wire-wrap)**

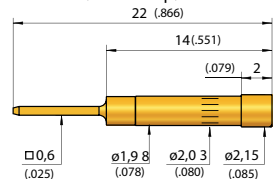

**Other contact terminals:**

**KT-254 W3 E12 (wire-wrap)**  
 For assembly in INGUN ZSK Transfer Field (ZSK = Top-side Contacting Unit)

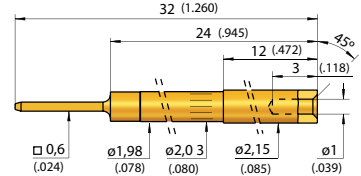

**KT-158 02 (Order No. 9408)**  
 Contacting Terminal for GenRad Interface

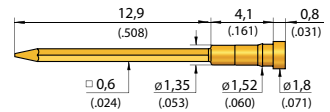

**KT-158 (Order No. 3650)**  
 Contacting Terminal for Zehntel Interface

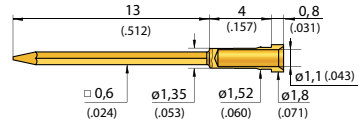

**KT-158 06 (Order No. 21814)**

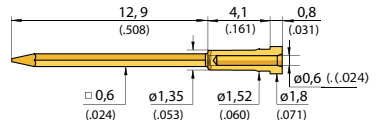

**KT-586 102 400 R**  
 Contacting Terminals for general usage

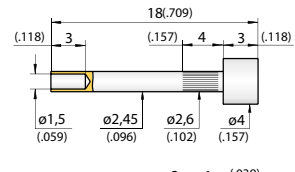

**KT-279 102 300**  
 (to solder in)

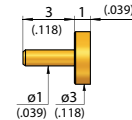

**KT-112 143 215 E02 (replaceable,**  
 will be used with KS-112)

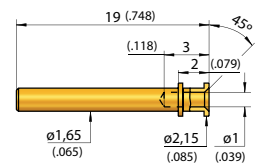

**Mounting hole size \***

- for KT-254:**  
in CEM1 und FR4       $\varnothing$  1,98 - 1,99 mm (.0780-.0783)
- for KT-158:**  
in CEM1 und FR4       $\varnothing$  1,38 - 1,40 mm (.0543 - .0551)
- for KT-586:**  
in CEM1 und FR4       $\varnothing$  2,55 - 2,57 mm (.1004-.1012)
- for KT-120:**  
in CEM1 und FR4       $\varnothing$  3,00 - 3,02 mm (.1181 - .1189)
- for KT-150:**  
in CEM1 und FR4       $\varnothing$  4,00 - 4,02 mm (.1575 - .1583)

**Collar height and install. height for KT-254**

The installation height of the contact terminals is determined by the collar height.

**Electrical data**

**R<sub>j</sub> typical:** < 5 mΩ

**Materials**

**Contact terminals:** Brass, gold-plated  
**KT-586:** Brass, rhodium-plated

**\* Services:**

Customised contact blocks drilled according to customer requirements (and which match certain INGUN receptacles) are available from INGUN.

# INGUN test fixtures and customising accessories

Series	Designation	Page	Series	Designation	Page
ATE MA260	Manual test fixture drive unit	25	KRM	Cleaning mats	206
ATE MA350	Manual test fixture drive unit	26	KT	Contact terminals	211
ATE MA360	Manual test fixture drive unit	27	LWL	Fibre optic cables	209
ATE VA	Vacuum test fixture drive units	136	MA 160	Manual interchangeable kit test fixture	24
ATS MA09	Exchangeable kit	36, 78	MA 2011	Manual single test fixtures	30
ATS MA09/ESD	ESD exchangeable kit	36, 78	MA 2012	Manual single test fixtures	30
ATS MA09/S-5	Exchangeable kit	36, 78	MA 2013	Manual single test fixtures	30
ATS MA09/S-5/ESD	ESD exchangeable kit	36, 78	MA 2013T	Manual single test fixtures	30
ATS MA11	Exchangeable kit	37, 42, 50, 53, 78	MA 2014	Manual single test fixtures	30
ATS MA11/ESD	ESD exchangeable kit	37, 42, 50, 53, 78	MA 2109	Manual interchangeable kit test fixtures	36
ATS MA11/HF	RF exchangeable kit	37, 42, 50, 53, 60, 78	MA 2111	Manual interchangeable kit test fixtures	27
ATS MA11/S-5	Exchangeable kit	37, 42, 50, 53, 78	MA 2112	Manual interchangeable kit test fixtures	38
ATS MA11/S-5/ESD	ESD exchangeable kit	37, 42, 50, 53, 78	MA 2113	Manual interchangeable kit test fixtures	40
ATS MA11/S-5/HF	RF exchangeable kit	37, 42, 50, 53, 60, 78	MA 2113T	Manual interchangeable kit test fixtures	42
ATS MA12	Exchangeable kit	38, 51, 78	MA 2114	Manual interchangeable kit test fixtures	44
ATS MA12/ESD	ESD exchangeable kit	38, 51, 78	MA 260	Manual interchangeable kit test fixture	25
ATS MA12/HF	RF exchangeable kit	38, 51, 60, 78	MA 3211	Manual interchangeable kit test fixtures	50
ATS MA12/S-7	Exchangeable kit	38, 51, 78	MA 3212	Manual interchangeable kit test fixtures	51
ATS MA12/S-7/ESD	ESD exchangeable kit	38, 51, 78	MA 3213	Manual interchangeable kit test fixtures	52
ATS MA12/S-7/HF	RF exchangeable kit	38, 51, 60, 78	MA 3213T	Manual interchangeable kit test fixtures	53
ATS MA13	Exchangeable kit	40, 52, 78	MA 3214	Manual interchangeable kit test fixtures	54
ATS MA13/ESD	ESD exchangeable kit	40, 52, 78	MA 350	Manual interchangeable kit test fixture	26
ATS MA13/HF	RF exchangeable kit	40, 52, 60, 78	MA 360	Manual interchangeable kit test fixtures	27
ATS MA13/S-10	Exchangeable kit	40, 52, 78	ME	Marking units	171
ATS MA13/S-10/ESD	ESD exchangeable kit	40, 52, 78	NDH	Vacuum test fixture pressure frame units	134
ATS MA13/S-10/HF	RF exchangeable kit	40, 52, 60, 78	NHS	Pushrods	194
ATS MA14	Exchangeable kit	44, 54, 78	PA 2130	Pneumatic interchangeable kit test fixtures	85
ATS MA14/ESD	ESD exchangeable kit	44, 54, 78	PAS	PCB support pins	197
ATS MA14/S-10	Exchangeable kit	44, 54, 78	PAZ 200	Pneumatic interchangeable kit test fixtures	82
ATS MA14/S-10/ESD	ESD exchangeable kit	44, 54, 78	PAZ 200-1	Pneumatic interchangeable kit test fixtures	82
ATS MA160	Exchangeable kit	24	PAZ 215	Pneumatic interchangeable kit test fixtures	83
ATS MA160/ESD	ESD exchangeable kit	24	PAZ 220	Pneumatic interchangeable kit test fixtures	83
ATS MA2112/S-7/SN	Rigid pin exchangeable kit	38, 51	PAZ 400	Pneumatic interchangeable kit test fixtures	84
ATS MA260	Exchangeable kit	25	PAZ 500-1	Pneumatic interchangeable kit test fixtures	84
ATS MA260/ESD	ESD exchangeable kit	25	PS	Test plugs	188
ATS MA350	Exchangeable kit	26	PUN	Compressed air hoses	209
ATS MA350/ESD	ESD exchangeable kit	26	Pylon receivers	Receivers for Pylon interface	123
ATS MA360	Exchangeable kit	27	SAM	Side approach mechanisms	179
ATS MA360/ESD	ESD exchangeable kit	27	SB	Interface blocks	155
ATS PA2130	Exchangeable kit	85	SBE	Screwing units	190
ATS PA2130/ESD	ESD exchangeable kit	85	Snap-on fasteners	Snap-on fasteners	208
ATS PAZ200	Exchangeable kit	82	SK	Start-up kits	154
ATS PAZ200/680	Exchangeable kit	82	STK	Connectors	186
ATS PAZ200/680/ESD	ESD exchangeable kit	82	TAB	Button activators	193
ATS PAZ200/ESD	ESD exchangeable kit	82	TF	Transfer fields	196
ATS PAZ215	Exchangeable kit	83	VA	Vacuum test fixtures without test system interface	92
ATS PAZ220	Exchangeable kit	83	VA – Cobham (Aeroflex)	Vacuum test fixtures with ... test system interface	96
ATS PAZ400	Exchangeable kit	84	VA – Digitaltest	Vacuum test fixtures with ... test system interface	97
ATS PAZ500/680	Exchangeable kit	84	VA – Keysight	Vacuum test fixtures with ... test system interface	100
ATS PAZ500/680/ESD	ESD exchangeable kit	84	VA – Pylon	Vacuum test fixtures with ... test system interface	121
ESD kits	ESD kits	207	VA – Reinhardt	Vacuum test fixtures with ... test system interface	109
FB-...	Functional units	65	VA – Spea	Vacuum test fixtures with ... test system interface	110
Feasa	Feasa LED analysers	209	VA – Teradyne	Vacuum test fixtures with ... test system interface	112
FED	Springs	203	VA – VPC	Vacuum test fixtures with ... test system interface	124
FS/GFS	Tooling pins / GFS tooling pins	198	VG	Multipoint connectors	205
FUB	Guide bushes	207	VKH	Vacuum test fixture vacuum hoods	137
FUS	Guide pins	207	VZ	Pre-centring pins	202
GDF	Gas pressure springs	204	WS	Interchangeable kits	143
GKS	Test probes for interfaces	210	ZSK	Vacuum test fixture additional contact units	138
HBS	Stroke limiting discs	207			
HF-A-...	RF absorbers	63			
HF-U-...	RF transfers	61			
HMK	Stroke sensors	208			
HZ	Stroke counters	208			

Please visit us online at:  
[www.ingun.com](http://www.ingun.com)

# Sealed with **EXCELLENCE.**

Contacting solutions up to 400 A for every industry and application. The **high current probes** from INGUN guarantee secure transmission of high currents. In addition, they enable precise measurements with limited warming and low internal resistance.

INGUN offers an unbeatable range of products:

- Standard high current probes
- Short stroke and long stroke
- Dipole high current probes
- Robust high current probes



High Current  
Test Probes

[www.ingun.com](http://www.ingun.com)

### **Company head office**

INGUN Germany

### **Subsidiaries**

INGUN Benelux  
INGUN China  
INGUN India  
INGUN Mexico  
INGUN Spain  
INGUN Switzerland  
INGUN South Korea  
INGUN Southeast Asia  
INGUN Turkey  
INGUN UK  
INGUN USA

### **Europe**

Austria  
Benelux  
Bosnia and Herzegovina  
Croatia  
Czech Republic  
Denmark  
Estonia  
Finland  
France  
Germany  
Hungary  
Italy  
Norway  
Poland  
Portugal  
Romania  
Serbia  
Slovakia  
Slovenia  
Spain  
Sweden  
Switzerland  
Turkey  
United Kingdom

### **Asia**

China  
Hong Kong  
India  
Israel  
Japan  
Malaysia  
South Korea  
Taiwan  
Thailand  
Vietnam

### **Africa**

South Africa  
Tunisia

### **Australia**

Australia  
New Zealand

### **America**

Argentina  
Brazil  
Canada  
Mexico  
USA

For the full addresses  
of our international  
offices please visit us  
at [www.ingun.com](http://www.ingun.com)

### **INGUN Prüfmittelbau GmbH**

Max-Stromeyer-Straße 162  
78467 Konstanz

Germany

Phone +49 7531 8105-0

Customer hotline +49 7531 8105-888

Fax +49 7531 8105-65

[info@ingun.com](mailto:info@ingun.com)

[www.ingun.com](http://www.ingun.com)